

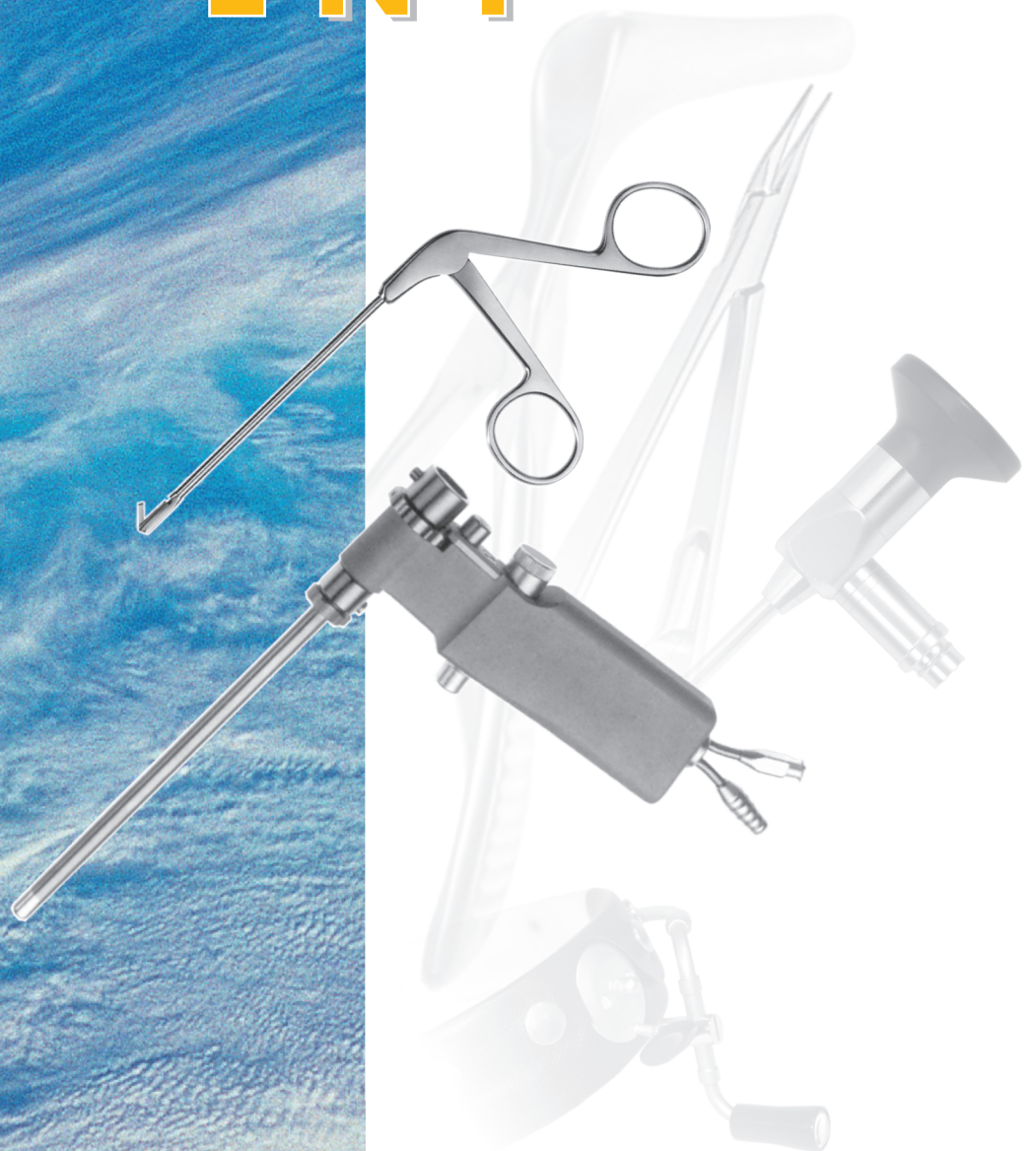

# STEMA

Medizintechnik GmbH

# HNO ENT









**Service/Zertifikate:**

Die STEMA Medizintechnik GmbH ist nach den höchsten Standards zertifiziert.

- DIN EN ISO 13485
- EG Richtlinien 93/42/EWG
- FDA

Diese Standards bilden eine essentielle Grundlage für unser Unternehmen und unsere Partner.

Sie symbolisieren ebenfalls das Engagement und Erstreben die Qualität unserer Produkte langfristig zu sichern.

**Service/Certificates:**

STEMA Medizintechnik GmbH is certified in accordance with the highest standards.

- DIN EN ISO 13485
- Council Directive 93/42/EEC
- FDA

These standards create an essential base for our company and our partners.

They also symbolize the commitment and strive to keep up the quality of our products.

**Produkte:**

Das aktuelle Produktsortiment der STEMA Medizintechnik GmbH umfasst mehr als 10.000 verschiedene Artikel.

Wir decken folgende Segmente für die Chirurgie mit qualitativ hochwertigen Produkten ab:

- Arthroskopie
- Bronchoskopie
- Container-Systeme
- Einweg-Artikel
- Gastro-Intestinal
- Geräte
- Gynäkologie
- HF-Chirurgie
- HNO
- Laparoskopie
- Mikromotoren-System
- Mund-, Kiefer- und Gesichtschirurgie
- Proktoskopie
- Thorakoskopie
- Urologie

***Bitte fordern Sie  
unsere Kataloge an***

Durch die enge Zusammenarbeit mit unseren Stamm-Lieferanten garantieren wir ein sehr hohes Qualitätsniveau.

Dies ist einer von vielen Gründen, die der Firma STEMA weltweit Kontakte zu verschiedenen Partnern eröffnet, in unserem Namen sowie im OEM-Bereich.

**Products:**

The current product range of STEMA Medizintechnik GmbH includes more than 10.000 different items.

We cover the following areas in Surgery with high quality products:

- Arthroscopy
- Bronchoscopy
- Container-Systems
- Disposable products
- ENT
- HF-Surgery
- Gastro-Intestinal
- Gynaecology
- Laparoscopy
- Micro motor system
- Oral, Maxillo and Facial surgery
- Proctoscopy
- Thoracoscopy
- Units
- Urology

***Please ask for our  
special catalogues***

A close cooperation with our suppliers guarantees a very high quality level.

This is one of many reasons which open STEMA contacts to various partners all over the world, in our name as well as on OEM base.



## INHALT STIRNLEUCHTEN CONTENT HEADLIGHTS

### STIRNLEUCHTEN / HEADLIGHTS

	SEITE / PAGE
Miniaturstirnleuchten / Miniature headlights .....	1
OP und HNO Stirnleuchten / OR and ENT headlights .....	2, 3
Verschiedene Stirnleuchten / Various headlights .....	4-8

## INHALT OTOLOGIE CONTENT OTOTOLOGY

### ENDOSKOPE / ENDOSCOPES

Autoklavierbare Optiken / Autoclavable scopes .....	11, 12
Otoskope / Otoloscopes .....	13

### SPEKULAS / SPECULUM

Ohrtrichter / Ear speculum .....	14-16
----------------------------------	-------

### DIAGNOSTIK UND ZUBEHÖR / DIAGNOSTIC AND ACCESSORIES

Stimmgabeln / Tuning forks .....	17-19
Lärmtrommeln / Noise boxes .....	19
Nystagmus Brillen / Nystagmus spectacles .....	20
Ohrspritzen / Ear syringes .....	21, 22
Hörschläuche / Diagnostic tubes .....	23
Ballone / Balloons .....	23
Zerstäuber / Atomizers .....	24
Pulverbläser / Powder blowers .....	24
Fixation / Fixation .....	25

### HANDINSTRUMENTE / HAND INSTRUMENTS

Watteträger / Cotton applicators .....	26
Ohrsonden, Ohrhebel, Ohrstopfer / Ear probes, ear spatulas, ear pusher .....	27
Ohrhäkchen / Ear hooks .....	28-31
Ohrschlingen / Ear loops .....	32
Ohrküretten / Ear curettes .....	33, 34
Scharfe Löffel / Sharp curettes .....	35
Parazithesenadeln / Tympanum perforators .....	36, 37
Ohrbesteck / Ear operating set .....	38
Nadeln / Needles .....	39
Ohrmesser / Ear knives .....	40-42
Rundschnittmesser / Flap knives .....	43
Messinstrumente / Measuring instruments .....	44
Dissektoren, Elevatoren, Perforatoren / Dissectors, elevators, perforators .....	45
Raspatorien / Raspatories .....	46, 47
Meißel / Chisels .....	53, 54
Hämmer / Hammers .....	55

### SAUGEN / SUCTION

Saugrohre / Suction tubes .....	48
Saug- und Spülrohre / Suction and irrigation tubes .....	49-52
Griffe und Adaptoren / Handles and adaptors .....	52

**ZANGEN / FORCEPS**
**SEITE / PAGE**

Ohrtamponzängchen, Ohrpinzetten / Ear tampon forceps, ear dressing forceps .....	56
Hammerkopfstanzen, Drahtschliesszangen / Hammer head punches, wire close forceps .....	57
Ohrzangen / Ear forceps .....	58-65
Mikro Fasszangen / Micro grasping forceps .....	66
Mikro Löffelzangen / Micro spoon forceps .....	67, 68
Scheren / Scissors .....	69-71
Mikro Scheren / Micro scissors .....	72

**SCHNÜRER / SNARES**

Ohrpolypenschnürer / Ear polypus snares .....	73
---	----

**SPEZIELLES / SPECIALS**

HEERMANN Instrumente und Zubehör / HEERMANN instruments and accessories .....	74
Paukenröhrchen und Zubehör / Vent tubes and accessories .....	75

**VERSCHIEDENES / VARIOUS**

Gelfoam-Quetschzange / Gelfoam-pressure forceps .....	76
Bieegerät / Bending block .....	76
Venenpresse / Vein press .....	76
Abziehstein / Stone .....	76
Präpariertablett / Metal plate .....	76

**INHALT RHINOLOGIE**  
**CONTENT RHINOLOGY**
**SPEKULA / SPECULA**
**SEITE / PAGE**

Nasenspekula / Nasal specula .....	79-83
------------------------------------	-------

**ZUBEHÖR / ACCESSORIES**

Fixation / Fixation .....	84
Zerstäuber, Pulverbläser / Atomizers, powder blowers .....	85

**HANDINSTRUMENTE / HAND INSTRUMENTS**

Watteträger, Lippensterrer / Cotton applicators, lip retractors .....	86
Haken, Retraktoren / Hooks, retractors .....	87-90
Nadeln, Messinstrumente / Needles, measuring instruments .....	91
Messer / Knives .....	92, 93
Sägen, Quetschen / Saws, crushers .....	94
Elevatoren / Elevators .....	95-97
Dissektoren / Dissectors .....	97
Raspatorien / Raspatories .....	98-102
Saugrohre, Saugkanülen / Suction tubes, suction cannulas .....	102
Meißel / Chisels .....	103-107
Osteotome / Osteotomes .....	108-113
Brecher / Crushers .....	113
Hämmer / Hammers .....	114

**ZANGEN / FORCEPS**

Nasenpinzetten / Nasal dressing forceps .....	114
Nasentampon- und Muschelquetschzangen / Nasal tampon and turbinate crushing forceps .....	115
Conchotome / Nasal cutting forceps .....	116
Nasenzangen mit Schiebeschäft / Nasal forceps with sliding sheath .....	117-119
Septumzangen / Septum forceps .....	120
Septumrichtzangen / Septum straightening forceps .....	121
Nasenzangen, Knorpelquetschzangen / Nasal forceps, septum morcelizers .....	122
Knochensplitterzangen, Knorpelzangen / Bone cutting forceps, nasal hump forceps .....	123



## SCHEREN / SCISSORS

Nasenscheren / Nasal scissors .....	124-126
-------------------------------------	---------

## INHALT SINUSKOPIE CONTENT SINUSCOPY

### ENDOSKOPE / ENDOSCOPES

	SEITE / PAGE
Autoklavierbare Optiken / Autoclavable scopes .....	129,130
Flexible Naso-Pharyngoskope / Flexible Nose-Pharyngoscopes .....	131

### TROKARE / TROCARS

Schäfte und Trokare / Sheaths and trocars .....	132, 133
---	----------

### HANDINSTRUMENTE / HAND INSTRUMENTS

Griffe, Sonden / Handles, probes .....	134
Küretten / Curettes .....	135
Löffel / Spoons .....	136
Messer, Dilatatoren / Knives, bougies .....	137
Elevatoren / Elevators .....	138
Raspatorien, Meißel / Raspatories, chisels .....	139

### SAUGEN-SPÜLEN / SUCTION-IRRIGATION

Spülkanülen / Suction cannulas .....	140-150
Saugrohre, Saugglas / Suction tubes, suction cup .....	148
Spül- und Punktionskanülen / Suction and puncture cannulas .....	150
Saug- und Spülhandgriff / Suction and irrigation handle .....	151

### ZANGEN / FORCEPS

Conchotome / Nasal cutting forceps .....	152
Nasenzangen mit Rohrschaft / Nasal forceps with tube sheath .....	153-156
Nasenzangen mit Rohrschaft und Absaugung / Nasal forceps with tube sheath and suction chann. ....	157, 158
Nasenzangen mit Schiebeschäft / Nasal forceps with sliding sheath .....	159-161
Nasenzangen mit Schiebeschäft und Absaug. / Nasal forceps with sliding sheath and suct. chann. ....	162
Nasenzangen mit integriertem Saugkanal / Nasal forceps with integrated suction channel .....	163
Verschiedene Zangen / Various forceps .....	164
Biopsiezangen / Biopsy forceps .....	165, 166
Siebbeinzangen / Ethmoid forceps .....	167

### STANZEN / PUNCHES

Antrumstanzen / Antrum punches .....	168
Antrumstanzen mit Absaugung / Antrum punches with suction channel .....	169
Ostium-, Rundkopf- und Meißelstanzen / Sinus, circular cutting and chisel-edged punches .....	170
Keilbeinstanzen / Sphenoid punches .....	171
Kieferhöhlenstanzen / Antrum rongeurs .....	172

### SCHEREN / SCISSORS

Nasenscheren / Nasal scissors .....	173
-------------------------------------	-----

## **INHALT TONSILLEKTOMIE**

### **CONTENT TONSILLECTOMY**

#### **RETRAKTOREN UND ZUBEHÖR / RETRACTORS AND ACCESSORIES**

	<b>SEITE / PAGE</b>
Mundsperrer / Mouth gags .....	177-179
Lippenhalter / Lip retractors .....	179
Zungenspatel / Tongue depressors .....	179
Zungendrücker / Tongue depressors .....	180,181
Retraktoren, Haken / Retractors, hooks .....	188

#### **ZUBEHÖR / ACCESSORIES**

Zerstäuber / Atomizers .....	182
------------------------------	-----

#### **HANDINSTRUMENTE / HAND INSTRUMENTS**

Ringmesser / Adenoid curettes .....	183
Adenotome, Küretten / Adenotomes, curettes .....	184
Tamponstopfer, Tonsillennadeln / Gauze packers, tonsil needles .....	185
Tonsillennmesser / Tonsil knives .....	186
Tonsillendissektoren, Tonsillenelevatoren / Tonsil dissectors, tonsil elevators .....	187
Tonsillenzangen, Tonsillenschere / Tonsil forceps, tonsil scissors .....	189
Kehlkopfspiegel / Laryngeal mirrors .....	190

#### **SCHNÜRER / SNARES**

Tonsillenschnürer / Tonsil snares .....	191, 192
Tonsillotome / Tonsilectomes .....	193
Schnürdrähte / Snare wires .....	194

## **INHALT LARYNGOSKOPIE**

### **CONTENT LARYNGOSCOPY**

#### **ENDOSKOPE / ENDOSCOPES**

Tele-Laryngo-Pharyngoskope / Tele-Laryngo-Pharyngoscopes .....	197
--	-----

#### **LARYNGOSKOPE UND ZUBEHÖR / LARYNGOSCOPES AND ACCESSORIES**

Laryngoskope / Laryngoscopes .....	198, 199
Operationslaryngoskope, Zubehör / Operating laryngoscopes, accessories .....	202
Griffe / Handles .....	199
Spatel / Blades .....	200, 201
Bruststützen / Chest support .....	203
Narkosebügel, Mundsperreraufhängung / Anaesthesia frame, suspension apparatus for mouth gag .....	204
Saugrohre, Spritzen / Suction tube, syringes .....	190

#### **HANDINSTRUMENTE / HAND INSTRUMENTS**

Laryngeale Mikroinstrumente / Laryngeal micro instruments .....	206-208
Laryngoskopie Instrumente / Laryngoscopy instruments .....	209-211
Flexible Zangen / Flexible forceps .....	212

## **INHALT CHIRURGIE**

### **CONTENT SURGERY**

#### **SKALPELLE / SCALPELS**

Skalpelli / Scalpel handles .....	215
Dermatom / Dermotome .....	215



## SCHEREN / SCISSORS

OP-Scheren / Operating scissors .....	216-219
Standardscheren / Standard scissors .....	220-223
Präparierscheren / Dissecting scissors .....	224, 225
Gefäß- und Sehnenscheren / Vascular and tenotomy scissors .....	226
Ligatur- und Strabismusscheren / Ligature and strabismus scissors .....	227
Nasen- und Tonsillenscheren / Nasal and tonsil scissors .....	228
Irisscheren / Iris scissors .....	229
Mikroscheren / Micro scissors .....	230-233

## PINZETTEN / FORCEPS

Anatomische Pinzetten / Dressing forceps .....	234
Chirurgische Pinzetten / Dissecting forceps .....	235
Atraumatische Pinzetten / Atrauma forceps .....	236
Irisspinzetten / Iris forceps .....	236
Uhrmacherpinzetten / Jeweler type forceps .....	236
Columellapinzetten / Columella forceps .....	236
Ohren- und Nasenpinzetten / Ear and nasal forceps .....	237
Mikropinzetten / Micro forceps .....	238
Verschiedene Pinzetten / Various forceps .....	238

## KLEMMEN / FORCEPS

Arterienklemmen / Haemostatic forceps .....	239-241
Verschiedene Klemmen / Various forceps .....	242, 243

## RETRAKTOREN / RETRACTORS

Wundhaken / Retractors .....	244-253
Nasenhaken / Nasal retractors .....	254
Wangenhaken / Cheek retractors .....	254
Kinnhalter / Chin retractors .....	254
Wundsperrer / Wound spreaders .....	255-259

## NAHT / SUTURE

Nadelhalter / Needle holders .....	260-262
Mikro Nadelhalter / Micro needle holders .....	263-268

## KNOCHENCHIRURGIE / BONE SURGERY

Scharfe Löffel / Bone curettes .....	269-271
Küretten / Curettes .....	272, 273
Knochensplitterzangen / Bone cutting forceps .....	274
Hohlmeisselzangen / Bone rongeurs .....	274, 275

## KRANIO-MAXILLOFAZIALE CHIRURGIE / CRANIO-MAXILLO-FACIAL SURGERY

Ahlen / Awles .....	276
Elevatoren / Elevators .....	277
Raspatorien / Raspatories .....	277
Osteotome / Osteotomes .....	278
Kronenschieber / Pusher .....	278
Drahtumführer / Wire pusher .....	279
Verschiedene Haken / Various retractors .....	279





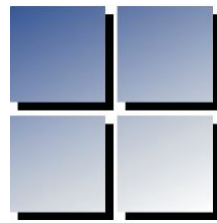

# STEMA

Medizintechnik GmbH

## Stirnleuchten

## Headlights

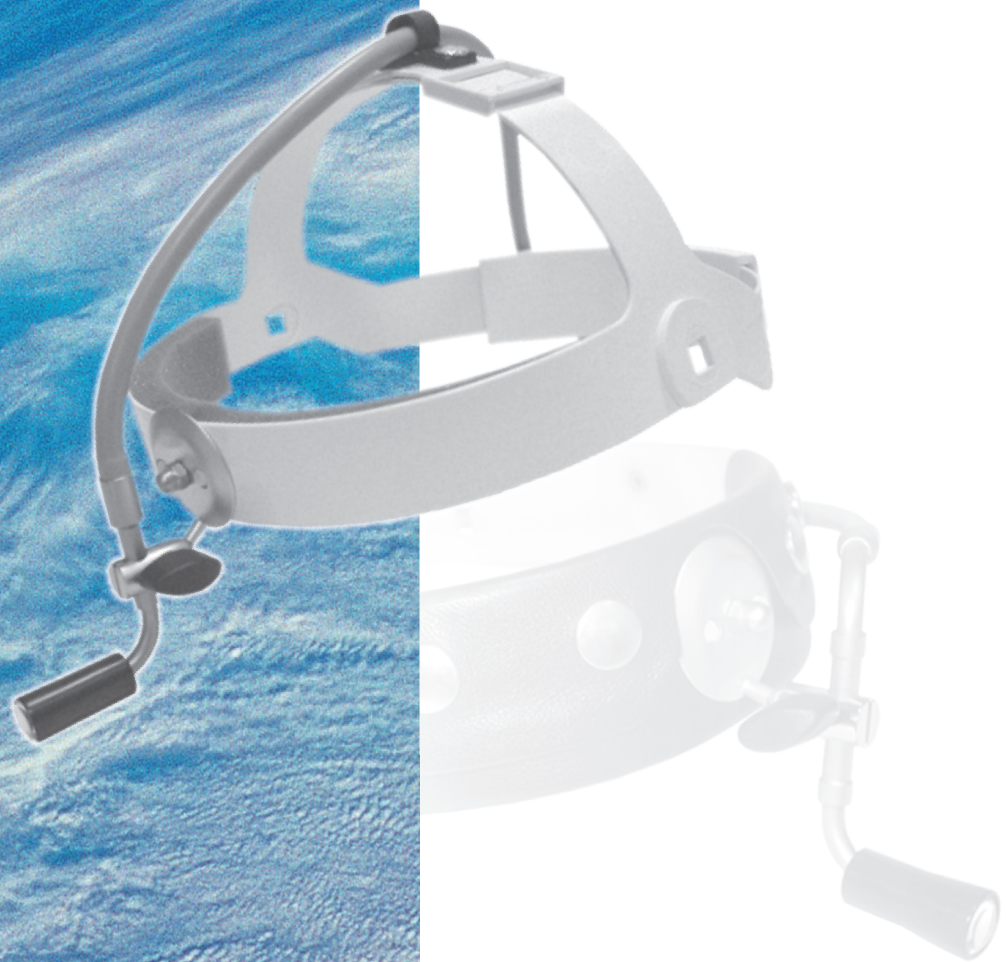





Bestell-Nr. Ordering no.	Bezeichnung Description
LA-050-001	Miniaturstirnleuchte mit Kopfbügelstirnband, Faserbündel Ø 3.5mm <i>Miniature headlight with cross band headband, fibre bundle Ø 3.5mm</i>
LA-050-002	Miniaturstirnleuchte mit Kopfbügelstirnband, Faserbündel Ø 3.5mm, Kabelende 90° abgewinkelt <i>Miniature headlight with cross band headband, fibre bundle Ø 3.5mm, cable end 90° angled</i>
LA-050-003	Miniaturstirnleuchte mit Kopfbügelstirnband, Faserbündel Ø 3.5mm, Kabel abnehmbar <i>Miniature headlight with cross band headband, fibre bundle Ø 3.5mm, cable detachable</i>
LA-050-004	Miniaturstirnleuchte mit Kopfbügelstirnband, Faserbündel Ø 3.5mm, Kabelende 90° abgewinkelt, Kabel abnehmbar <i>Miniature headlight with cross band headband, fibre bundle Ø 3.5mm, cable end 90° angled, cable detachable</i>



Bestell-Nr. Ordering no.	Bezeichnung Description
LA-050-005	Miniaturstirnleuchte mit Komfortstirnband, Faserbündel Ø 3.5mm <i>Miniature headlight with comfort headband, fibre bundle Ø 3.5mm</i>
LA-050-006	Miniaturstirnleuchte mit Komfortstirnband, Faserbündel Ø 3.5mm, Kabelende 90° abgewinkelt <i>Miniature headlight with comfort headband, fibre bundle Ø 3.5mm, cable end 90° angled</i>



<b>Bestell-Nr.</b> <b>Ordering no.</b>	<b>Bezeichnung</b> <b>Description</b>
<b>LA-050-007</b>	OP Stirnleuchte mit Kopfbügelstirnband <i>Headlight for operation theatre with cross band</i>
<b>LA-050-008</b>	OP Stirnleuchte mit Kopfbügelstirnband, Kabelende 90° abgewinkelt <i>Headlight for operation theatre with cross band, cable end 90° angled</i>



<b>Bestell-Nr.</b> <b>Ordering no.</b>	<b>Bezeichnung</b> <b>Description</b>
<b>LA-050-010</b>	HNO Stirnleuchte nach CLAR, silberbeschichteter Spiegelreflektor, inkl. Kaltlichtkabel <i>ENT headlight by CLAR, silver coated concave mirror, incl. cold light cable</i>
<b>LA-050-011</b>	HNO Stirnleuchte nach CLAR, silberbeschichteter Spiegelreflektor, inkl. Kaltlichtkabel, Kabelende 90° abgewinkelt <i>ENT headlight by CLAR, silver coated concave mirror, incl. cold light cable, cable end 90° angled</i>



Bestell-Nr. Ordering no.	Bezeichnung Description
LA-050-012	HNO Stirnleuchte mit Mikrofokus, stufenlos, inkl. Kaltlichtkabel <i>ENT headlight with microfocus, stepless, incl. cold light cable</i>
LA-050-013	HNO Stirnleuchte mit Mikrofokus, stufenlos, inkl. Kaltlichtkabel, Kabelende 90° abgewinkelt <i>ENT headlight with microfocus, stepless, incl. cold light cable, cable end 90° angled</i>
LA-050-014	HNO Stirnleuchte mit Mikrofokus, stufenlos, Stirnbandversion, inkl. Kaltlichtkabel <i>ENT headlight with microfocus, stepless, headband version, incl. cold light cable</i>
LA-050-015	HNO Stirnleuchte mit Mikrofokus, stufenlos, Stirnbandversion, inkl. Kaltlichtkabel, Kabelende 90° abgewinkelt <i>ENT headlight with microfocus, stepless, headband version, incl. cold light cable, cable end 90° angled</i>

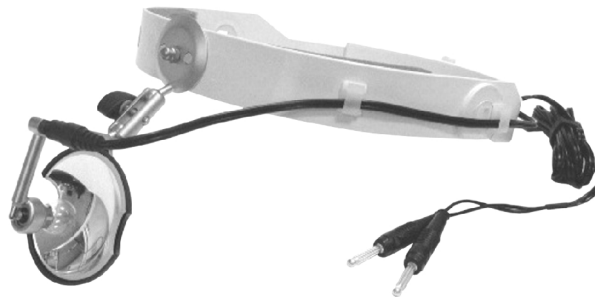

Bestell-Nr. Ordering no.	Bezeichnung Description
LA-050-020	Stirnleuchte nach CLAR Ø 98mm, 6V, 2.4W, silberbeschichteter Reflektorspiegel, Kabel 2 m, Bananenstecker <i>Headlight by CLAR Ø 98mm, 6V, 2.4W, silver coated concave mirror, cable 2m, banana plug</i>
LA-050-021	Stirnleuchte nach CLAR Ø 55mm, 6V, 2.4W, silberbeschichteter Reflektorspiegel, Kabel 2 m, Bananenstecker <i>Headlight by CLAR Ø 55mm, 6V, 2.4W, silver coated concave mirror, cable 2m, banana plug</i>





<b>Bestell-Nr.</b> <b>Ordering no.</b>	<b>Bezeichnung</b> <b>Description</b>
<b>LA-050-022</b>	LED Stirnleuchte nach CLAR Ø 55mm, 6V, 2.4W, silberbeschichteter Reflektorspiegel, inkl. Batteriebox <i>LED headlight by CLAR Ø 55mm, 6V, 2.4W, silver coated concave mirror, incl. battery box</i>



<b>Bestell-Nr.</b> <b>Ordering no.</b>	<b>Bezeichnung</b> <b>Description</b>
<b>LA-050-023</b>	Stirnleuchte nach CLAR F, Ø 55mm, Lichtfokussierung, Kabel 2m, Bananenstecker, Spannungsquelle 4V <i>Headlight by CLAR F, Ø 55mm, adjustable light beam, cable 2m, banana plug, power source 4V</i>
<b>LA-050-024</b>	Stirnleuchte nach CLAR F, Ø 55mm, Lichtfokussierung, Kabel 2m, Bananenstecker, Spannungsquelle 6V <i>Headlight by CLAR F, Ø 55mm, adjustable light beam, cable 2m, banana plug, power source 6V</i>
<b>LA-050-025</b>	Stirnleuchte nach CLAR F, Ø 55mm, Lichtfokussierung, Kabel 2m, Bananenstecker, Spannungsquelle 10V <i>Headlight by CLAR F, Ø 55mm, adjustable light beam, cable 2m, banana plug, power source 10V</i>





<b>Bestell-Nr. Ordering no.</b>	<b>Bezeichnung Description</b>
<b>LA-050-026</b>	Stirnleuchte nach CLAR S, Reflektorhohlspiegel Ø 55mm, Kabel 2m, Bananenstecker, Spannungsquelle 4V <i>Headlight by CLAR S, concave mirror Ø 55mm, cable 2m, banana plug, power source 4V</i>
<b>LA-050-027</b>	Stirnleuchte nach CLAR S, Reflektorhohlspiegel Ø 55mm, Kabel 2m, Bananenstecker, Spannungsquelle 6V <i>Headlight by CLAR S, concave mirror Ø 55mm, cable 2m, banana plug, power source 6V</i>
<b>LA-050-028</b>	Stirnleuchte nach CLAR S, Reflektorhohlspiegel Ø 55mm, Kabel 2m, Bananenstecker, Spannungsquelle 10V <i>Headlight by CLAR S, concave mirror Ø 55mm, cable 2m, banana plug, power source 10V</i>

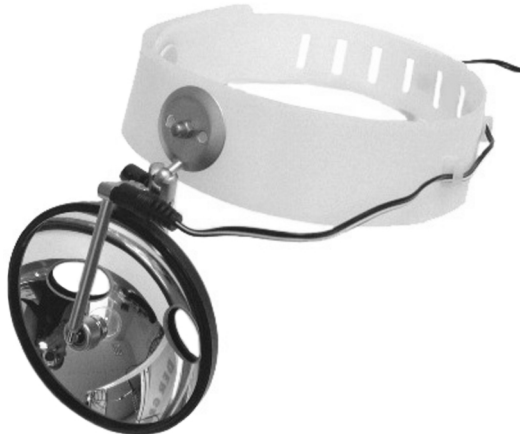

<b>Bestell-Nr. Ordering no.</b>	<b>Bezeichnung Description</b>
<b>LA-050-029</b>	Stirnleuchte nach CLAR S, Reflektorhohlspiegel Ø 98mm, Kabel 2m, Bananenstecker, Spannungsquelle 4V <i>Headlight by CLAR S, concave mirror Ø 98mm, cable 2m, banana plug, power source 4V</i>
<b>LA-050-030</b>	Stirnleuchte nach CLAR S, Reflektorhohlspiegel Ø 98mm, Kabel 2m, Bananenstecker, Spannungsquelle 6V <i>Headlight by CLAR S, concave mirror Ø 98mm, cable 2m, banana plug, power source 6V</i>
<b>LA-050-031</b>	Stirnleuchte nach CLAR S, Reflektorhohlspiegel Ø 98mm, Kabel 2m, Bananenstecker, Spannungsquelle 10V <i>Headlight by CLAR S, concave mirror Ø 98mm, cable 2m, banana plug, power source 10V</i>



<b>Bestell-Nr. Ordering no.</b>	<b>Bezeichnung Description</b>
<b>LA-050-040</b>	HIGH LIGHT Miniaturstirnleuchte mit Komfortstirnband, Faserbündel Ø 2.6mm <i>HIGH LIGHT miniature headlight with comfort headband, fibre bundle Ø 2.6mm</i>
<b>LA-050-041</b>	HIGH LIGHT Miniaturstirnleuchte mit Komfortstirnband, Faserbündel Ø 2.6mm, Kabelende 90° abgewinkelt <i>HIGH LIGHT miniature headlight with comfort headband, fibre bundle Ø 2.6mm, cable end 90° angled</i>
<b>LA-050-042</b>	OP HIGH LIGHT Miniaturstirnleuchte mit Komfortstirnband, Faserbündel Ø 2.6mm <i>OR HIGH LIGHT miniature headlight with comfort headband, fibre bundle Ø 2.6mm</i>
<b>LA-050-043</b>	OP HIGH LIGHT Miniaturstirnleuchte mit Komfortstirnband, Faserbündel Ø 2.6mm, Kabelende 90° abgewinkelt <i>OR HIGH LIGHT miniature headlight with comfort headband, fibre bundle Ø 2.6mm, cable end 90° angled</i>



<b>Bestell-Nr. Ordering no.</b>	<b>Bezeichnung Description</b>
<b>LA-050-050</b>	XENON MIKRO Stirnleuchte <i>XENON MICRO headlight</i>



Bestell-Nr. Ordering no.	Bezeichnung Description
LA-050-051	LED Stirnleuchte, inkl. Batteriebox LED headlight, incl. battery box



Bestell-Nr. Ordering no.	Bezeichnung Description
LA-050-060	Stirnlampe nach JANSEN, Spannungsquelle 4V, Kabel 2m Bananenstecker Headlight by JANSEN, power source 4V, cable 2m banana plug
LA-050-061	Stirnlampe nach JANSEN, Spannungsquelle 6V, Kabel 2m Bananenstecker Headlight by JANSEN, power source 6V, cable 2m banana plug
LA-050-062	Stirnlampe nach JANSEN, Spannungsquelle 10V, Kabel 2m Bananenstecker Headlight by JANSEN, power source 10V, cable 2m banana plug



<b>Bestell-Nr.</b> <b>Ordering no.</b>	<b>Bezeichnung</b> <b>Description</b>
<b>LA-050-065</b>	XENON Stirnleuchte mit integrierter Batteriebox <i>XENON headlight with integrated battery box</i>



<b>Bestell-Nr.</b> <b>Ordering no.</b>	<b>Bezeichnung</b> <b>Description</b>
<b>LA-050-070</b>	Reflexspiegel nach ZIEGLER, Ø 90mm <i>Headmirror by ZIEGLER, Ø 90mm</i>
<b>LA-050-071</b>	Reflexspiegel nach ZIEGLER, Ø 100mm <i>Headmirror by ZIEGLER, Ø 100mm</i>



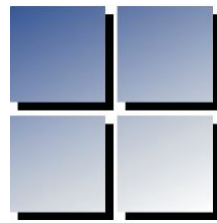

**STEMA**

Medizintechnik GmbH

**OTOLOGIE**

**OTOLOGY**









	<b>Bestell-Nr. Ordering no.</b>	<b>Durchmesser Diameter</b>	<b>Blickwinkel Viewing angle</b>	<b>Nutzlänge Working length</b>
<b>1.9</b>	LA-004-001	1.9mm	0°	69mm
	LA-004-002	1.9mm	30°	69mm
	LA-005-001	1.9mm	0°	102mm
	LA-005-002	1.9mm	30°	102mm
<b>2.4</b>	LA-006-001	2.4mm	0°	110mm
	LA-006-002	2.4mm	30°	110mm
	LA-007-001	2.4mm	0°	123mm
	LA-007-002	2.4mm	30°	123mm
<b>2.7</b>	LA-000-001	2.7mm	0°	41mm
	LA-000-002	2.7mm	30°	41mm
	LA-003-001	2.7mm	0°	110mm
	LA-003-002	2.7mm	30°	110mm
	LA-003-003	2.7mm	70°	110mm
	LA-001-001	2.7mm	0°	175mm
	LA-001-002	2.7mm	30°	175mm
	LA-001-003	2.7mm	70°	175mm
	LA-001-004	2.7mm	0°	187.5mm
	LA-001-005	2.7mm	30°	187.5mm
LA-001-006	2.7mm	70°	187.5mm	
<b>3.0</b>	LA-000-005	3.0mm	0°	41mm



**4.0**





Bestell-Nr. Ordering no.	Durchmesser Diameter	Blickwinkel Viewing angle	Nutzlänge Working length
LA-000-003	4.0mm	0°	50mm
LA-000-004	4.0mm	30°	50mm
LA-002-005	4.0mm	0°	110mm
LA-002-006	4.0mm	30°	110mm
LA-002-008	4.0mm	45°	110mm
LA-002-007	4.0mm	70°	110mm
LA-002-009	4.0mm	0°	142mm
LA-002-010	4.0mm	30°	142mm
LA-002-012	4.0mm	45°	142mm
LA-002-011	4.0mm	70°	142mm
LA-002-001	4.0mm	0°	175mm
LA-002-002	4.0mm	30°	175mm
LA-002-004	4.0mm	45°	175mm
LA-002-003	4.0mm	70°	175mm
LA-002-013	4.0mm	0°	187.5mm
LA-002-014	4.0mm	30°	187.5mm
LA-002-016	4.0mm	45°	187.5mm
LA-002-015	4.0mm	70°	187.5mm



Bestell-Nr. Ordering no.	Bezeichnung Description
ES-008-001	Anti-Beschlagmittel, 7ml, 20 Stück pro Box Anti-Fog solution, 7ml, 20 pieces each box



<b>Bestell-Nr.</b> <b>Ordering no.</b>	<b>Bezeichnung</b> <b>Description</b>
<b>LA-020-001</b>	Otoskop HL 2.5V, Griff C Otoscope HL 2.5V, handle C

Bestell-Nr. Ordering no.	Durchmesser Diameter	Bezeichnung Description		
LF-001-001	4.0mm außen (Fig. 1) / outer (fig. 1)			
LF-001-002	5.0mm außen (Fig. 2) / outer (fig. 2)			
LF-001-003	5.6mm außen / outer			
LF-001-004	6.0mm außen (Fig. 3) / outer (fig. 3)			
LF-001-005	6.6mm außen / outer			
LF-001-006	7.0mm außen (Fig. 4) / outer (fig. 4)	FARRIOR Ohrtrichter <b>rund</b> FARRIOR ear speculum <b>round</b>		
LF-001-007	7.5mm außen / outer			
LF-001-008	8.0mm außen (Fig. 5) / outer (fig. 5)			
LF-001-009	8.5mm außen (Fig. 6) / outer (fig. 6)			
LF-001-010	10.0mm außen (Fig. 7) / outer (fig. 7)			
LF-001-011	3.8 x 4.8mm (Fig. 1) / (fig. 1)			
LF-001-012	4.8 x 5.8mm (Fig. 2) / (fig. 2)			
LF-001-013	5.3 x 6.3mm (Fig. 3) / (fig. 3)			
LF-001-014	5.8 x 6.8mm (Fig. 4) / (fig. 4)	FARRIOR Ohrtrichter <b>oval</b> FARRIOR ear speculum <b>oval</b>		
LF-001-015	6.3 x 7.3mm (Fig. 5) / (fig. 5)			
LF-001-016	6.8 x 7.8mm (Fig. 6) / (fig. 6)			
LF-001-017	7.3 x 8.3mm (Fig. 7) / (fig. 7)			
LF-001-018	7.8 x 8.8mm (Fig. 8) / (fig. 8)			
LF-001-019	8.3 x 9.3mm (Fig. 9) / (fig. 9)			
LF-001-020	3.8 x 4.8mm (Fig. 1) / (fig. 1)			
LF-001-021	4.8 x 5.8mm (Fig. 2) / (fig. 2)			
LF-001-022	5.3 x 6.3mm (Fig. 3) / (fig. 3)			
LF-001-023	5.8 x 6.8mm (Fig. 4) / (fig. 4)	FARRIOR Ohrtrichter <b>oval, 20°</b> abgeschrägt FARRIOR ear speculum <b>oval, 20°</b> oblique		
LF-001-024	6.3 x 7.3mm (Fig. 5) / (fig. 5)			
LF-001-025	6.8 x 7.8mm (Fig. 6) / (fig. 6)			
LF-001-026	7.3 x 8.3mm (Fig. 7) / (fig. 7)			
LF-001-027	7.8 x 8.8mm (Fig. 8) / (fig. 8)			
LF-001-028	8.3 x 9.3mm (Fig. 9) / (fig. 9)			
LF-001-030	3.8 x 4.8mm (Fig. 1) / (fig. 1)			
LF-001-031	4.8 x 5.8mm (Fig. 2) / (fig. 2)			
LF-001-032	5.3 x 6.3mm (Fig. 3) / (fig. 3)			
LF-001-033	5.8 x 6.8mm (Fig. 4) / (fig. 4)	FARRIOR Ohrtrichter <b>oval, 35°</b> abgeschrägt FARRIOR ear speculum <b>oval, 35°</b> oblique		
LF-001-034	6.3 x 7.3mm (Fig. 5) / (fig. 5)			
LF-001-035	6.8 x 7.8mm (Fig. 6) / (fig. 6)			
LF-001-036	7.3 x 8.3mm (Fig. 7) / (fig. 7)			
LF-001-037	7.8 x 8.8mm (Fig. 8) / (fig. 8)			
LF-001-038	8.3 x 9.3mm (Fig. 9) / (fig. 9)			

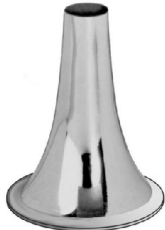
Bestell-Nr. Ordering no.	Durchmesser Diameter	Bezeichnung Description	
LF-001-050	3.0mm außen (Fig. 0) / outer (fig. 0)		
LF-001-051	4.0mm außen (Fig. 1) / outer (fig. 1)		
LF-001-052	5.0mm außen (Fig. 2) / outer (fig. 2)	HARTMANN Ohrtrichter HARTMANN ear speculum	
LF-001-053	6.0mm außen (Fig. 3) / outer (fig. 3)		
LF-001-054	7.5mm außen (Fig. 4) / outer (fig. 4)		
LF-001-056	3.0mm innen (Fig. 1) / inner (fig. 1)		
LF-001-057	4.0mm innen (Fig. 2) / inner (fig. 2)	HARTMANN Ohrtrichter <b>rund, schwarz mattiert</b> HARTMANN ear speculum <b>round, black finish</b>	
LF-001-058	5.0mm innen (Fig. 3) / inner (fig. 3)		
LF-001-059	7.0mm innen (Fig. 4) / inner (fig. 4)		

Bestell-Nr. Ordering no.	Durchmesser Diameter	Bezeichnung Description
LF-001-060	2.0mm innen (Fig. 1) / inner (fig. 1)	POLITZER Ohrtrichter für Kinder POLITZER ear speculum for children
LF-001-061	3.0mm innen (Fig. 2) / inner (fig. 2)	
LF-001-062	4.0mm innen (Fig. 3) / inner (fig. 3)	
LF-001-063	5.0mm innen (Fig. 4) / inner (fig. 4)	



Bestell-Nr. Ordering no.	Durchmesser Diameter	Bezeichnung Description
LF-001-065	4.0mm außen (Fig. 1) / outer (fig. 1)	TOYNBEE Ohrtrichter TOYNBEE ear speculum
LF-001-066	5.0mm außen (Fig. 2) / outer (fig. 2)	
LF-001-067	6.0mm außen (Fig. 3) / outer (fig. 3)	
LF-001-068	7.5mm außen (Fig. 4) / outer (fig. 4)	



Bestell-Nr. Ordering no.	Durchmesser Diameter	Bezeichnung Description
LF-001-070	5.5 x 6.5mm außen (Fig. 1) / outer (fig. 1)	ZÖLLNER Ohrtrichter <b>oval</b> ZÖLLNER ear speculum <b>oval</b>
LF-001-071	6.5 x 7.5mm außen (Fig. 2) / outer (fig. 2)	
LF-001-072	7.5 x 8.5mm außen (Fig. 3) / outer (fig. 3)	
LF-001-073	8.5 x 9.5mm außen (Fig. 4) / outer (fig. 4)	
LF-001-074	9.5 x 10.5mm außen (Fig. 5) / outer (fig. 5)	
LF-001-075	10.5 x 11.5mm außen (Fig. 6) / outer (fig. 6)	



Bestell-Nr. Ordering no.	Durchmesser Diameter	Bezeichnung Description
LF-001-080	3.8 x 4.8mm außen (Fig. 1) / outer (fig. 1)	GRUBER Ohrtrichter <b>oval</b> GRUBER ear speculum <b>oval</b>
LF-001-081	4.8 x 5.8mm außen (Fig. 2) / outer (fig. 2)	
LF-001-082	6.0 x 7.2mm außen (Fig. 3) / outer (fig. 3)	
LF-001-083	7.0 x 8.2mm außen (Fig. 4) / outer (fig. 4)	



Bestell-Nr. Ordering no.	Durchmesser Diameter	Bezeichnung Description
LF-001-085	4.5mm außen (Fig. 1) / outer (fig. 1)	BOUCHERON Ohrtrichter BOUCHERON ear speculum
LF-001-086	5.5mm außen (Fig. 2) / outer (fig. 2)	
LF-001-087	6.5mm außen (Fig. 3) / outer (fig. 3)	
LF-001-088	7.5mm außen (Fig. 4) / outer (fig. 4)	



Bestell-Nr. Ordering no.	Durchmesser Diameter	Bezeichnung Description
LF-001-090	4.0mm außen (Fig. 00) / outer (fig. 00)	BRÜNING'S Ohrtrichter BRÜNING'S ear speculum
LF-001-091	4.8mm außen (Fig. 0) / outer (fig. 0)	
LF-001-092	6.0mm außen (Fig. 1) / outer (fig. 1)	
LF-001-093	7.0mm außen (Fig. 2) / outer (fig. 2)	
LF-001-094	8.5mm außen (Fig. 3) / outer (fig. 3)	
LF-001-095	10.5mm außen (Fig. 4) / outer (fig. 4)	



Bestell-Nr. Ordering no.	Durchmesser Diameter	Bezeichnung Description
LF-001-100	5.0mm außen / outer	HOLMGREN Endaural Spekulum, <b>selbsthaltend, schwarz eloxiert</b> HOLMGREN endaural speculum, <b>self adjusting, black finishing</b>
LF-001-101	6.0mm außen / outer	
LF-001-102	6.0mm außen / outer	



Bestell-Nr. Ordering no.	Durchmesser Diameter	Bezeichnung Description
LF-001-105	3.0mm außen / outer	RICHNAU-HOLMGREN Ohrspekulum RICHNAU-HOLMGREN ear speculum
LF-001-106	4.0mm außen / outer	
LF-001-107	5.0mm außen / outer	
LF-001-108	7.0mm außen / outer	





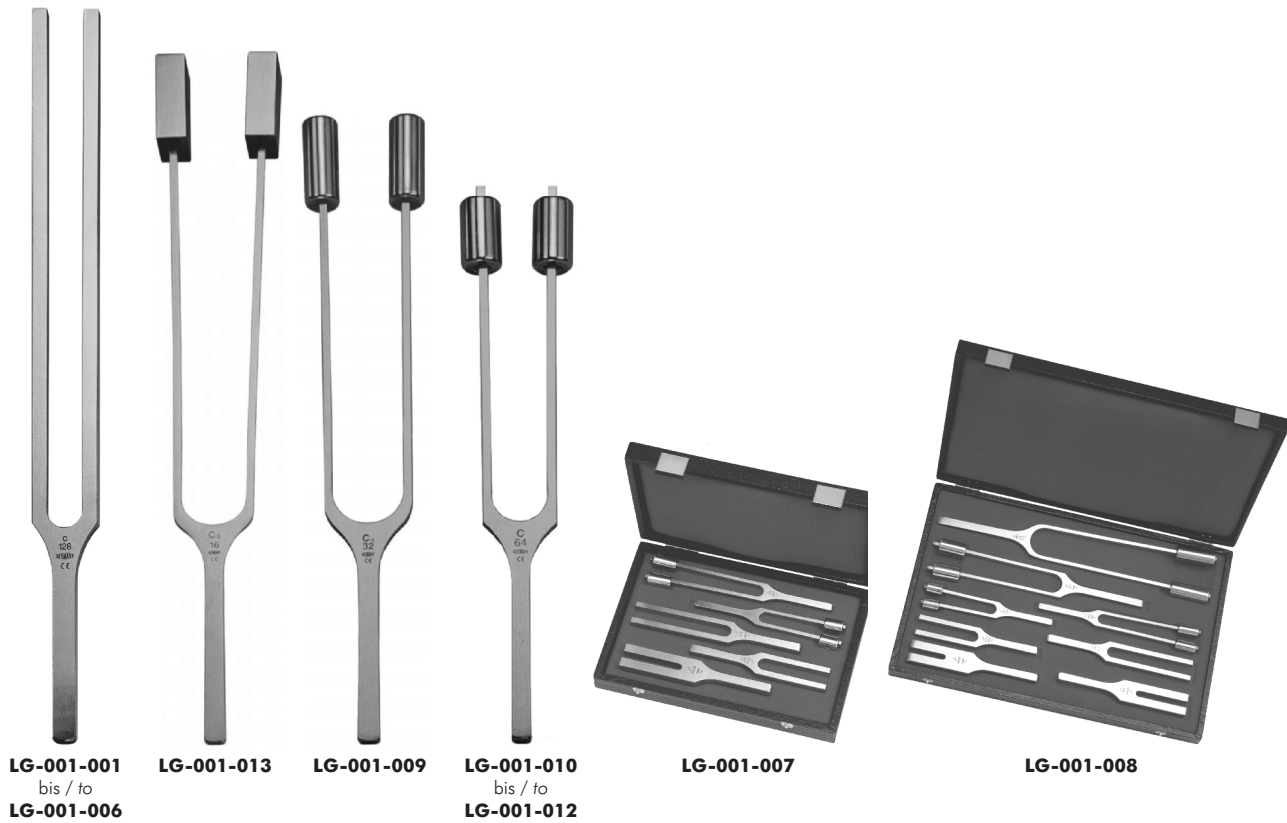

Bestell-Nr. Ordering no.	Bezeichnung Description
<b>LG-001-001</b>	HARTMANN Stimmgabel, C 128 HARTMANN tuning fork, C 128
<b>LG-001-002</b>	HARTMANN Stimmgabel, C 256 HARTMANN tuning fork, C 256
<b>LG-001-003</b>	HARTMANN Stimmgabel, C 512 HARTMANN tuning fork, C 512
<b>LG-001-004</b>	HARTMANN Stimmgabel, C 1024 HARTMANN tuning fork, C 1024
<b>LG-001-005</b>	HARTMANN Stimmgabel, C 2048 HARTMANN tuning fork, C 2048
<b>LG-001-006</b>	HARTMANN Stimmgabel, C 4096 HARTMANN tuning fork, C 4096
<b>LG-001-007</b>	HARTMANN Stimmgabel Set, 5 Stück, LG-001-001 bis LG-001-005, im Etui HARTMANN tuning fork set, 5 pcs., LG-001-001 to LG-001-005, in case
<b>LG-001-008</b>	HARTMANN Stimmgabel Set, 8 Stück, LG-001-009, LG-001-001 bis LG-001-006, im Etui HARTMANN tuning fork set, 8 pcs., LG-001-009, LG-001-001 to LG-001-006, in case
<b>LG-001-009</b>	French Stimmgabel, C 1 32 French tuning fork, C 1 32
<b>LG-001-010</b>	HARTMANN Stimmgabel, mit Dämpfer, C 64 HARTMANN tuning fork, with clamps, C 64
<b>LG-001-011</b>	HARTMANN Stimmgabel, mit Dämpfer, C 128 HARTMANN tuning fork, with clamps, C 128
<b>LG-001-012</b>	HARTMANN Stimmgabel, mit Dämpfer, C 256 HARTMANN tuning fork, with clamps, C 256
<b>LG-001-013</b>	French Stimmgabel, C 1 16 French tuning fork, C 1 16

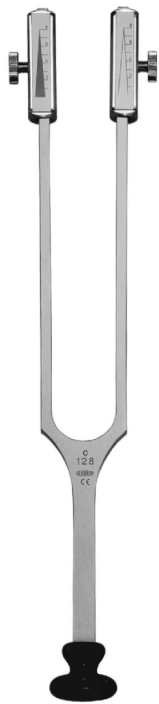

**LG-001-015**

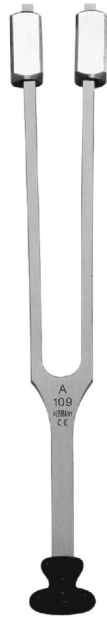

**LG-001-017**



**LG-001-025**  
bis / to  
**LG-001-027**

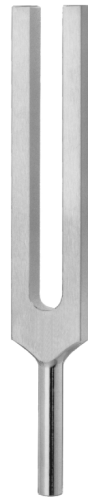

**LG-001-020**  
bis / to  
**LG-001-023**



**LG-001-016**



**LG-001-028**

<b>Bestell-Nr.</b> <b>Ordering no.</b>	<b>Bezeichnung</b> <b>Description</b>
<b>LG-001-015</b>	RYDEL SEIFFER Stimmgabel, Dämpfer abnehmbar, C 64 / C 128 <i>RYDEL SEIFFER tuning fork, with clamps, detachable C 64 / C 128</i>
<b>LG-001-016</b>	Stimmgabel, mit Fuß, a1 = 440 Hz <i>Tuning fork, with foot, a1 = 440H</i>
<b>LG-001-017</b>	KÖNIG Stimmgabel mit Fuss, verstellbar bis g <i>KÖNIG tuning fork, movable up to g</i>
<b>LG-001-020</b>	Stimmgabel Aluminium, C 512 <i>Tuning fork aluminium, C 512</i>
<b>LG-001-021</b>	Stimmgabel Aluminium, C 1024 <i>Tuning fork aluminium, C 1024</i>
<b>LG-001-022</b>	Stimmgabel Aluminium, C 2048 <i>Tuning fork aluminium, C 2048</i>
<b>LG-001-023</b>	Stimmgabel Aluminium, C 4096 <i>Tuning fork aluminium, C 4096</i>
<b>LG-001-025</b>	Stimmgabel Aluminium, mit Dämpfer, C 64 <i>Tuning fork aluminium, with clamps, C 64</i>
<b>LG-001-026</b>	Stimmgabel Aluminium, mit Dämpfer, C 128 <i>Tuning fork aluminium, with clamps, C 128</i>
<b>LG-001-027</b>	Stimmgabel Aluminium, mit Dämpfer, C 256 <i>Tuning fork aluminium, with clamps, C 256</i>
<b>LG-001-028</b>	Stimmgabel Aluminium Set, 5 Stück, LG-001-020 bis LG-001-022, LG-001-026, LG-001-027, im Etui <i>Tuning fork aluminium set, 5 pcs., LG-001-020 to LG-001-022, LG-001-026, LG-001-027, in case</i>

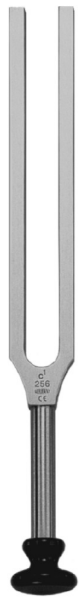

**LG-002-001**  
bis / to  
**LG-002-006**

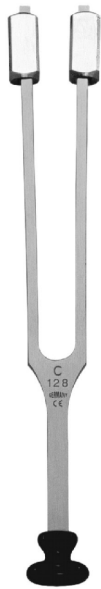

**LG-002-011**



**LG-003-001**



**LG-003-002**

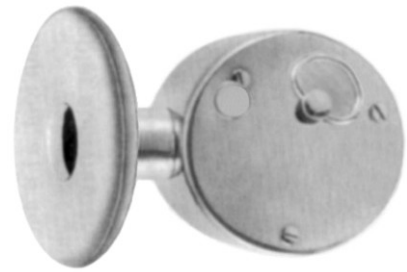

**LG-003-003**



**LG-003-004**

Bestell-Nr. Ordering no.	Bezeichnung Description
<b>LG-002-001</b>	LUCAE Stimmgabel, C 128 <i>LUCAE tuning fork, C 128</i>
<b>LG-002-002</b>	LUCAE Stimmgabel, C 256 <i>LUCAE tuning fork, C 256</i>
<b>LG-002-003</b>	LUCAE Stimmgabel, C 512 <i>LUCAE tuning fork, C 512</i>
<b>LG-002-004</b>	LUCAE Stimmgabel, C 1024 <i>LUCAE tuning fork, C 1024</i>
<b>LG-002-005</b>	LUCAE Stimmgabel, C 2048 <i>LUCAE tuning fork, C 2048</i>
<b>LG-002-006</b>	LUCAE Stimmgabel, C 4096 <i>LUCAE tuning fork, C 4096</i>
<b>LG-002-011</b>	LUCAE Stimmgabel, C 128, verschiebbar <i>LUCAE tuning fork, C 128, variable</i>
<b>LG-003-001</b>	BARANY Lärmtrommel mit Olive <i>BARANY noise box with olive</i>
<b>LG-003-002</b>	Olive für LG-003-001 <i>Olive for LG-003-001</i>
<b>LG-003-003</b>	BARANY Lärmtrommel mit Gummikissen <i>BARANY noise box with rubber pad</i>
<b>LG-003-004</b>	Gummikissen für LG-003-003 <i>Rubber pad for LG-003-003</i>

**LA-100-001 /**  
**LA-100-011**

**LA-100-004**

<b>Bestell-Nr.</b> <b>Ordering no.</b>	<b>Bezeichnung</b> <b>Description</b>
<b>LA-100-001</b>	FRENZEL Nystagmus Brille, 1.5m Zuleitung, Bananenstecker, Clip-Kopfband <i>FRENZEL nystagmus spectacle, 1.5m cord, banana plug, clip headband</i>
<b>LA-100-002</b>	FRENZEL Nystagmus Brille, Batteriegriff, Lichtstärke regulierbar (ohne Abbildung) <i>FRENZEL nystagmus spectacle, battery handle, illumination adjustable (without illustration)</i>
<b>LA-100-003</b>	FRENZEL Nystagmus Brille, regelbarer Batteriegriff, Kabel und Clip-Kopfband (ohne Abbildung) <i>FRENZEL nystagmus spectacle, battery handle, cable, clip headband (without illustration)</i>
<b>LA-100-004</b>	FRENZEL Nystagmus Brille, feste Gläsern und Batteriegriff <i>FRENZEL nystagmus spectacle, fixed glasses and battery handle</i>
<b>LA-100-005</b>	Batteriegriff allein (ohne Abbildung) <i>Battery handle only (without illustration)</i>
<b>LA-100-006</b>	Kabel Bajonettstecker (ohne Abbildung) <i>Cable bayonett plug (without illustration)</i>
<b>LA-100-007</b>	Kabel Bananenstecker (ohne Abbildung) <i>Cable banana plug (without illustration)</i>
<b>LA-100-008</b>	Clip-Kopfband (ohne Abbildung) <i>Clip headband (without illustration)</i>
<b>LA-100-009</b>	Ersatzlampe (ohne Abbildung) <i>Spare bulb (without illustration)</i>
<b>LA-100-011</b>	BLESSING Nystagmus Brille, weiss, 1.5m Zuleitung, Bananenstecker, Clip-Kopfband <i>BLESSING nystagmus spectacle, white, 1.5m cord, banana plug, clip headband</i>
<b>LA-100-012</b>	BLESSING Nystagmus Brille, weiss, Batteriegriff, Lichtstärke regulierbar (ohne Abbildung) <i>BLESSING nystagmus spectacle, white, battery handle, illumination adjustable (without illustration)</i>
<b>LA-100-013</b>	BLESSING Nystagmus Brille, weiss, regelbarer Batteriegriff, Kabel und Clip-Kopfband (ohne Abbildung) <i>BLESSING nystagmus spectacle, white, battery handle, cable, clip headband (without illustration)</i>



**LJ-002-001**  
bis / to  
**LJ-002-015**



**LJ-002-016**



**LJ-002-017**



**LJ-002-018**



**LJ-002-019**



**LJ-002-020**



**LJ-002-021**



**LJ-002-022**

Bestell-Nr. Ordering no.	Bezeichnung Description
<b>LJ-002-001</b>	SCHIMMELBUSCH Ganzmetallspritze, Luer-Lock, komplett mit Schutzteller und 2 Ansätzen, 50ml <i>SCHIMMELBUSCH syringe metal, luer-lock, complete with shield and 2 tips, 50ml</i>
<b>LJ-002-002</b>	SCHIMMELBUSCH Ganzmetallspritze, Luer-Lock, komplett mit Schutzteller und 2 Ansätzen, 75ml <i>SCHIMMELBUSCH syringe metal, luer-lock, complete with shield and 2 tips, 75ml</i>
<b>LJ-002-003</b>	SCHIMMELBUSCH Ganzmetallspritze, Luer-Lock, komplett mit Schutzteller und 2 Ansätzen, 100ml <i>SCHIMMELBUSCH syringe metal, luer-lock, complete with shield and 2 tips, 100ml</i>
<b>LJ-002-004</b>	SCHIMMELBUSCH Ganzmetallspritze, Luer-Lock, komplett mit Schutzteller und 2 Ansätzen, 150ml <i>SCHIMMELBUSCH syringe metal, luer-lock, complete with shield and 2 tips, 150ml</i>
<b>LJ-002-005</b>	SCHIMMELBUSCH Ganzmetallspritze, Luer-Lock, komplett mit Schutzteller und 2 Ansätzen, 200ml <i>SCHIMMELBUSCH syringe metal, luer-lock, complete with shield and 2 tips, 200ml</i>
<b>LJ-002-006</b>	SCHIMMELBUSCH Ganzmetallspritze, Luer-Lock, komplett mit 2 Ansätzen, 50ml <i>SCHIMMELBUSCH syringe metal, luer-lock, complete with 2 tips, 50ml</i>
<b>LJ-002-007</b>	SCHIMMELBUSCH Ganzmetallspritze, Luer-Lock, komplett mit 2 Ansätzen, 75ml <i>SCHIMMELBUSCH syringe metal, luer-lock, complete with 2 tips, 75ml</i>
<b>LJ-002-008</b>	SCHIMMELBUSCH Ganzmetallspritze, Luer-Lock, komplett mit 2 Ansätzen, 100ml <i>SCHIMMELBUSCH syringe metal, luer-lock, complete with 2 tips, 100ml</i>
<b>LJ-002-009</b>	SCHIMMELBUSCH Ganzmetallspritze, Luer-Lock, komplett mit 2 Ansätzen, 150ml <i>SCHIMMELBUSCH syringe metal, luer-lock, complete with 2 tips, 150ml</i>
<b>LJ-002-010</b>	SCHIMMELBUSCH Ganzmetallspritze, Luer-Lock, komplett mit 2 Ansätzen, 200ml <i>SCHIMMELBUSCH syringe metal, luer-lock, complete with 2 tips, 200ml</i>
<b>LJ-002-011</b>	SCHIMMELBUSCH Ganzmetallspritze, Luer-Lock, nur Spritze, 50ml <i>SCHIMMELBUSCH syringe metal, luer-lock, syringe only, 50ml</i>
<b>LJ-002-012</b>	SCHIMMELBUSCH Ganzmetallspritze, Luer-Lock, nur Spritze, 75ml <i>SCHIMMELBUSCH syringe metal, luer-lock, syringe only, 75ml</i>
<b>LJ-002-013</b>	SCHIMMELBUSCH Ganzmetallspritze, Luer-Lock, nur Spritze, 100ml <i>SCHIMMELBUSCH syringe metal, luer-lock, syringe only, 100ml</i>
<b>LJ-002-014</b>	SCHIMMELBUSCH Ganzmetallspritze, Luer-Lock, nur Spritze, 150ml <i>SCHIMMELBUSCH syringe metal, luer-lock, syringe only, 150ml</i>
<b>LJ-002-015</b>	SCHIMMELBUSCH Ganzmetallspritze, Luer-Lock, nur Spritze, 200ml <i>SCHIMMELBUSCH syringe metal, luer-lock, syringe only, 200ml</i>
<b>LJ-002-016</b>	Ansatz (allein) konisch <i>Cannula (only) conical</i>
<b>LJ-002-017</b>	Ansatz (allein) olivenförmig <i>Cannula (only) olive end</i>
<b>LJ-002-018</b>	Ansatz (allein) olivenförmig groß <i>Cannula (only) olive end big</i>
<b>LJ-002-019</b>	Ansatz (allein) konisch kurz <i>Cannula (only) conical short</i>
<b>LJ-002-020</b>	Ansatz (allein) konisch groß <i>Cannula (only) conical big</i>
<b>LJ-002-021</b>	Ansatz (allein) olivenförmig gebogen <i>Cannula (only) olive end curved</i>
<b>LJ-002-022</b>	Schutzteller <i>Protection shield</i>



**LJ-002-025**



**LJ-002-026**



**LJ-002-027**



**LJ-002-028**



**LJ-002-029**



**LJ-002-030**



**LJ-002-031**



**LJ-002-032**



**LJ-002-033**

<b>Bestell-Nr.</b> <b>Ordering no.</b>	<b>Bezeichnung</b> <b>Description</b>
<b>LJ-002-025</b>	Ganzmetall Ohrspritze, selbstfüllend, Luer-Lock, verchromt, 10ml, komplettes Set bestehend aus: 4 Kanülen, 1 Schutzteller, 1 Saugfuss und 1 Ventilaufsatz <i>Ear syringe metal, self filling, luer-lock, chrome plated, 10 ml, complete set consisting of: 4 cannulas, 1 protection shield, 1 suction end and 1 valve attachment</i>
<b>LJ-002-026</b>	Ganzmetall Ohrspritze, selbstfüllend, Luer-Lock, verchromt, 10ml, mit Ventil und Ansätzen <i>Ear syringe metal, self filling, luer-lock, chrome plated, 10 ml, with valve and cannulas</i>
<b>LJ-002-027</b>	Ganzmetall Ohrspritze, selbstfüllend, Luer-Lock, verchromt, 10ml, mit Ansätzen <i>Ear syringe metal, self filling, luer-lock, chrome plated, 10 ml, with cannulas</i>
<b>LJ-002-028</b>	Ansatz (allein) konisch <i>Cannula (only) conical</i>
<b>LJ-002-029</b>	Ansatz (allein) olivenförmig <i>Cannula (only) oliv end</i>
<b>LJ-002-030</b>	Ansatz (allein) kugel olivenförmig <i>Cannula (only) ball olive end</i>
<b>LJ-002-031</b>	Ansatz (allein) konisches Gewinde <i>Cannula (only) conical thread</i>
<b>LJ-002-032</b>	Ventil komplett <i>Valve complete</i>
<b>LJ-002-033</b>	Schutzteller <i>Protection shield</i>





LH-001-277



LH-001-278



LH-001-269



LH-001-275



LH-001-276



LH-001-270  
bis / to  
LH-001-274



LJ-003-013



LJ-003-014



LJ-003-015



LJ-003-016



LJ-003-017



LJ-003-018

Bestell-Nr. Ordering no.	Bezeichnung Description
LH-001-269	Gummiballon für HARTMANN Tubenkatheter, 2,5 Unzen Rubber balloon for HARTMANN tube catheter, 2.5 ounces
LH-001-270	HARTMANN Tubenkatheter, Luer-Lock, Fig. 1 HARTMANN tube catheter, luer-lock, fig. 1
LH-001-271	HARTMANN Tubenkatheter, Luer-Lock, Fig. 2 HARTMANN tube catheter, luer-lock, fig. 2
LH-001-272	HARTMANN Tubenkatheter, Luer-Lock, Fig. 3 HARTMANN tube catheter, luer-lock, fig. 3
LH-001-273	HARTMANN Tubenkatheter, Luer-Lock, Fig. 4 HARTMANN tube catheter, luer-lock, fig. 4
LH-001-274	HARTMANN Tubenkatheter, Luer-Lock, Fig. 5 HARTMANN tube catheter, luer-lock, fig. 5
LH-001-275	Metallolive für Tubenkatheter Metal olive for tube catheter
LH-001-276	WILLIAMS Tubenkatheter, 12cm, Ø 2mm, flexibel, Luer-Lock WILLIAMS tube catheter, 12cm, Ø 2mm, flexible, luer-lock
LH-001-277	JANSEN Hörschlauch, 1 schwarze und 6 verchromte Oliven (3 versch. Größen), inkl. Ständer JANSEN diagnostic tube, 1 black and 6 chrome plated olives (3 diff. sizes), incl. rack
LH-001-278	LUCAE Hörschlauch, 1 schwarze und 1 weiße Olive LUCAE diagnostic tube, 1 black and 1 white olive
LJ-003-011	POLITZER Aseptic, komplett mit 3 Nasen- und 1 Ohrolive, in Kunststoffbox POLITZER Aseptic, complete with 3 nasal and 1 ear tip, in plastic box
LJ-003-012	POLITZER Aseptic, komplett mit 3 Nasen- und 1 Ohrolive POLITZER Aseptic, complete with 3 nasal and 1 ear tip
LJ-003-013	POLITZER Gummiballon POLITZER rubber balloon
LJ-003-014	Einsteckkonus für POLITZER Gummiballon Connecting nozzle for POLITZER rubber balloon
LJ-003-015	Ohrolive, Ø 4mm Ear olive, Ø 4mm
LJ-003-016	Nasenolive, Ø 15mm Nose olive, Ø 15mm
LJ-003-017	Nasenolive, Ø 17mm Nose olive, Ø 17mm
LJ-003-018	Nasenolive, Ø 22mm Nose olive, Ø 22mm



**LJ-003-001**  
bis / to  
**LJ-003-003**

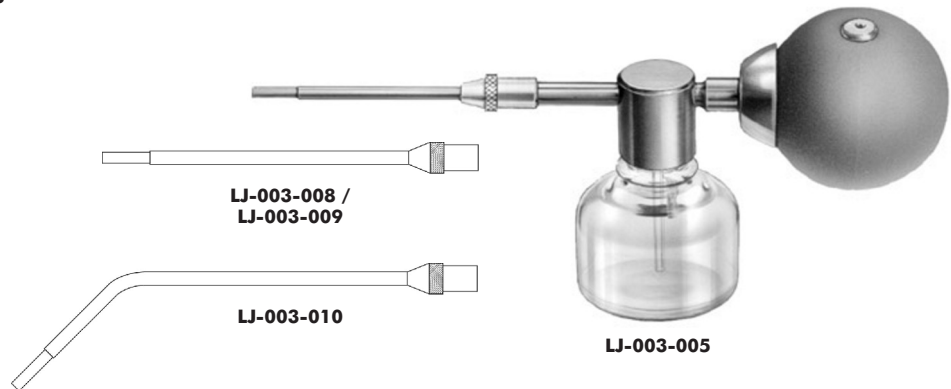

**LJ-003-008 /**  
**LJ-003-009**

**LJ-003-010**

**LJ-003-005**

<b>Bestell-Nr.</b> <b>Ordering no.</b>	<b>Bezeichnung</b> <b>Description</b>
<b>LJ-003-001</b>	Universal Zerstäuber mit beweglicher Düse, Schraubflasche 30ccm und Halbgebläse <i>Universal atomizer with movable nozzle, threaded bottle 30ccm and rubber bulb</i>
<b>LJ-003-002</b>	Universal Zerstäuber mit beweglicher Düse, Schraubflasche 30ccm <i>Universal atomizer with movable nozzle, threaded bottle 30ccm</i>
<b>LJ-003-003</b>	Halbgebläse allein <i>Rubber bulb only</i>
<b>LJ-003-005</b>	KABIERSKE Pulverbläser, komplett mit 3 Kanülen und Halbgebläse <i>KABIERSKE powder blower, complete with 3 cannulas and rubber bulb</i>
<b>LJ-003-006</b>	KABIERSKE Ersatzflasche, 30ccm <i>KABIERSKE spare bottle, 30ccm</i>
<b>LJ-003-007</b>	Halbgebläse allein <i>Rubber bulb only</i>
<b>LJ-003-008</b>	Kanüle gerade, 8cm <i>Cannula straight, 8cm</i>
<b>LJ-003-009</b>	Kanüle gerade, 11cm <i>Cannula straight, 11cm</i>
<b>LJ-003-010</b>	Kanüle gebogen, 13cm <i>Cannula curved, 13cm</i>



LL-001-001



LL-001-002



LL-001-003



LL-001-004

<b>Bestell-Nr. Ordering no.</b>	<b>Bezeichnung Description</b>
LL-001-001	Flexibler Spannarm, komplett mit Haltestange zur Befestigung an OP-Tischschiene <i>Flexible tension arm, complete with holding rod for attachment to operating table</i>
LL-001-002	Spannkolben für Spannarm <i>Rotation clamp for tension arm</i>
LL-001-003	Ohrtrichterhalter <i>Ear speculum clamp</i>
LL-001-004	Optikhalter <i>Endoscope holder</i>

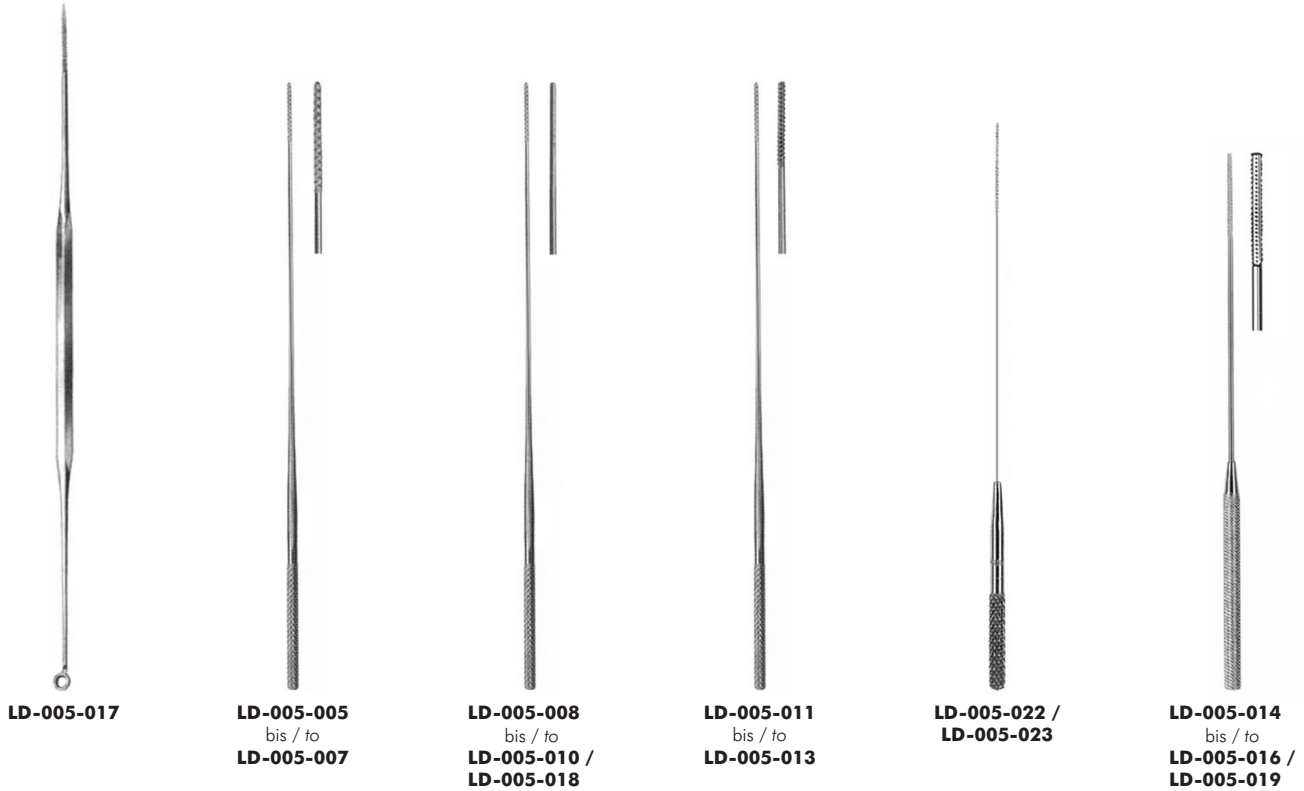

Bestell-Nr. Ordering no.	Bezeichnung Description
LD-005-005	Watteträger, gerieft, Ø 1.2mm, 12cm Cotton applicator, serrated, Ø 1.2mm, 12cm
LD-005-006	Watteträger, gerieft, Ø 1.2mm, 14cm Cotton applicator, serrated, Ø 1.2mm, 14cm
LD-005-007	Watteträger, gerieft, Ø 1.2mm, 16cm Cotton applicator, serrated, Ø 1.2mm, 16cm
LD-005-008	Watteträger, dreikant, Ø 1.2mm, 12cm Cotton applicator, triangular, Ø 1.2mm, 12cm
LD-005-009	Watteträger, dreikant, Ø 1.2mm, 14cm Cotton applicator, triangular, Ø 1.2mm, 14cm
LD-005-010	Watteträger, dreikant, Ø 1.2mm, 16cm Cotton applicator, triangular, Ø 1.2mm, 16cm
LD-005-011	FARREL Watteträger, spiralförmig, Ø 1.0mm, 12cm FARREL cotton applicator, twisted end, Ø 1.0mm, 12cm
LD-005-012	FARREL Watteträger, spiralförmig, Ø 1.0mm, 14cm FARREL cotton applicator, twisted end, Ø 1.0mm, 14cm
LD-005-013	FARREL Watteträger, spiralförmig, Ø 1.0mm, 16cm FARREL cotton applicator, twisted end, Ø 1.0mm, 16cm
LD-005-014	FARREL Watteträger, dreikant gerieft, Ø 1.0mm, 12cm FARREL cotton applicator, triangular serrated, Ø 1.0mm, 12cm
LD-005-015	FARREL Watteträger, dreikant gerieft, Ø 1.0mm, 14cm FARREL cotton applicator, triangular serrated, Ø 1.0mm, 14cm
LD-005-016	FARREL Watteträger, dreikant gerieft, Ø 1.0mm, 16cm FARREL cotton applicator, triangular serrated, Ø 1.0mm, 16cm
LD-005-017	JOBSON-HORNE Watteträger und Kürette, 18cm JOBSON-HORNE cotton applicator and curette, 18cm
LD-005-018	Watteträger, gerieft, Ø 1.5mm, 18cm Cotton applicator, serrated, Ø 1.5mm, 18cm
LD-005-019	FARREL Watteträger, dreikant gerieft, Ø 1.2mm, 18cm FARREL cotton applicator, triangular serrated, Ø 1.2mm, 18cm
LD-005-020	FEIN Watteträger, 28cm (ohne Abbildung) FEIN cotton applicator, 28cm (without illustration)
LD-005-022	ATTIKUS Watteträger, Gewinde, Ø 0.7mm, 11cm ATTIKUS cotton applicator, threaded, Ø 0.7mm, 11cm
LD-005-023	ATTIKUS Watteträger, Gewinde, Ø 0.7mm, 15cm ATTIKUS cotton applicator, threaded, Ø 0.7mm, 15cm



LD-005-001



LD-005-002



LD-005-003



LD-007-001



LD-007-002



LD-007-003



LD-007-004



LD-005-001 /  
 LD-005-002

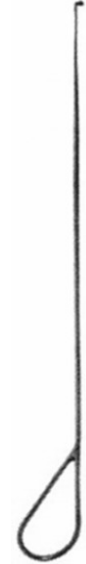

LD-005-003

Bestell-Nr. Ordering no.	Bezeichnung Description
LD-005-001	STACKE Ohrsonde, neusilber, 11cm STACKE ear probe, silver plated, 11cm
LD-005-002	STACKE Ohrsonde, silber, 11cm STACKE ear probe, silver, 11cm
LD-005-003	STACKE-FRENZEL Ohrsonde, abgewinkelt, silber, 9cm STACKE-FRENZEL ear probe, angled, silver, 9cm
LD-007-001	MOLDENHAUER Ohrhebel, 16cm MOLDENHAUER ear spatula, 16cm
LD-007-002	ZAUFAL Ohrhebel, 16cm ZAUFAL ear spatula, 16cm
LD-007-003	QUIRE Ohrhebel, 9cm QUIRE foreign body lever, 9cm
LD-007-004	BLOCH Ohrstopfer, 16cm BLOCH ear pusher, 16cm



**LD-003-051**



**LD-003-060 /  
LD-003-061**



**LD-003-022  
bis / to  
LD-003-026**



**LD-003-052  
bis / to  
LD-003-054**



**LD-003-059**



**LD-003-069**

<b>Bestell-Nr.</b> <b>Ordering no.</b>	<b>Bezeichnung</b> <b>Description</b>
<b>LD-003-022</b>	WAGENER Ohrhäkchen, fein, Fig. 1, 14cm WAGENER ear hook, fine, fig. 1, 14cm
<b>LD-003-023</b>	WAGENER Ohrhäkchen, fein-mittel, Fig. 2, 14cm WAGENER ear hook, fine-medium, fig. 2, 14cm
<b>LD-003-024</b>	WAGENER Ohrhäkchen, mittel, Fig. 3, 14cm WAGENER ear hook, medium, fig. 3, 14cm
<b>LD-003-025</b>	WAGENER Ohrhäkchen, mittel-stark, Fig. 4, 14cm WAGENER ear hook, medium-strong, fig. 4, 14cm
<b>LD-003-026</b>	WAGENER Ohrhäkchen, stark, Fig. 5, 14cm WAGENER ear hook, strong, fig. 5, 14cm
<b>LD-003-051</b>	JOSEPH Häkchen, einzahnig, 16cm JOSEPH hook, single tooth, 16cm
<b>LD-003-052</b>	LUCAE Häkchen, fein, Fig. 1, 14cm LUCAE hook, fine, fig. 1, 14cm
<b>LD-003-053</b>	LUCAE Häkchen, mittel, Fig. 2, 14cm LUCAE hook, medium, fig. 2, 14cm
<b>LD-003-054</b>	LUCAE Häkchen, stark, Fig. 3, 14cm LUCAE hook, strong, fig. 3, 14cm
<b>LD-003-059</b>	GROSS Ohrhäkchen und Löffel, 13cm GROSS ear hook and spoon, 13cm
<b>LD-003-060</b>	DAY Ohrhäkchen, fein, Fig. 1, 15cm DAY ear hook, fine, fig. 1, 15cm
<b>LD-003-061</b>	DAY Ohrhäkchen, mittel, Fig. 2, 15cm DAY ear hook, medium, fig. 2, 15cm
<b>LD-003-069</b>	FRAZIER Häkchen, 1-zahnig, stumpf, 13cm FRAZIER hook, 1 prong, blunt, 13cm



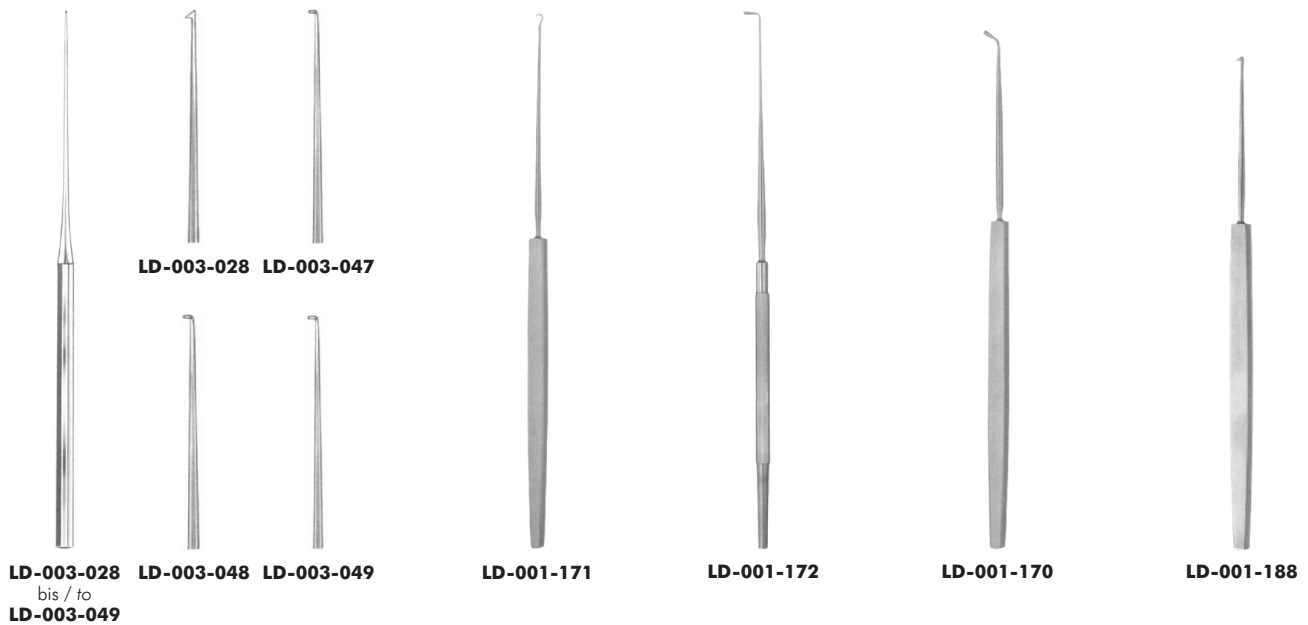

Bestell-Nr. Ordering no.	Bezeichnung Description
LD-001-170	YANKAUER Ohrhäkchen, 15cm YANKAUER ear hook, 15cm
LD-001-171	HARTMANN Ohrhäkchen, 16cm HARTMANN ear hook, 16cm
LD-001-172	ALLPORT Ohrhäkchen, 16cm ALLPORT ear hook, 16cm
LD-001-188	JACOBSSEN Ohrhäkchen, 14cm JACOBSSEN ear hook, 14cm
LD-001-197	PLESTER Häkchen, retrograd, 2mm, 15.5cm (ohne Abbildung) PLESTER hook, retrograde, 2mm, 15.5cm (without illustration)
LD-001-199	Häkchen, einzahnig, 110°, 14cm (ohne Abbildung) Hook, single prong, 110°, 14cm (without illustration)
LD-001-199-1	Häkchen, einzahnig, 180°, 14cm (ohne Abbildung) Hook, single prong, 180°, 14cm (without illustration)
LD-003-028	ROSEN Ohrhäkchen, retrograd schneidend, 16cm ROSEN ear hook, retrograd cutting, 16cm
LD-003-047	FISCH Fußplattenhäkchen, 0.2mm, 16cm FISCH foot plate hook, 0.2mm, 16cm
LD-003-048	PLESTER Fußplattenhäkchen, 0.6mm, 16cm PLESTER foot plate hook, 0.6mm, 16cm
LD-003-049	PLESTER Fußplattenhäkchen, 0.4mm, 16cm PLESTER foot plate hook, 0.4mm, 16cm

<b>Bestell-Nr.</b> <b>Ordering no.</b>	<b>Bezeichnung</b> <b>Description</b>
<b>LD-003-014</b>	SHAMBAUGH Häkchen, 90° abgewinkelt, 0.4mm <i>SHAMBAUGH hook, 90° angled, 0.4mm</i>
<b>LD-003-015</b>	SHAMBAUGH Häkchen, 90° abgewinkelt, 0.5mm <i>SHAMBAUGH hook, 90° angled, 0.5mm</i>
<b>LD-003-017</b>	SHAMBAUGH Häkchen, 90° abgewinkelt, 0.2mm <i>SHAMBAUGH hook, 90° angled, 0.2mm</i>
<b>LD-003-018</b>	SHAMBAUGH Häkchen, 90° abgewinkelt, 0.6mm <i>SHAMBAUGH hook, 90° angled, 0.6mm</i>
<b>LD-003-029</b>	SHAMBAUGH Häkchen, 90° abgewinkelt, 1.0mm <i>SHAMBAUGH hook, 90° angled, 1.0mm</i>
<b>LD-003-083</b>	SHAMBAUGH Häkchen, 90° abgewinkelt, 0.8mm <i>SHAMBAUGH hook, 90° angled, 0.8mm</i>
<b>LD-003-084</b>	SHAMBAUGH Häkchen, 90° abgewinkelt, 1.2mm <i>SHAMBAUGH hook, 90° angled, 1.2mm</i>
<b>LD-003-085</b>	SHAMBAUGH Häkchen, 90° abgewinkelt, 1.5mm <i>SHAMBAUGH hook, 90° angled, 1.5mm</i>
<b>LD-003-086</b>	SHAMBAUGH Häkchen, 90° abgewinkelt, 2.0mm <i>SHAMBAUGH hook, 90° angled, 2.0mm</i>
<b>LD-003-087</b>	SHAMBAUGH Häkchen, 90° abgewinkelt, 2.5mm <i>SHAMBAUGH hook, 90° angled, 2.5mm</i>
<b>LD-003-037</b>	SHAMBAUGH Häkchen, 45° abgewinkelt, 0.3mm <i>SHAMBAUGH hook, 45° angled, 0.3mm</i>
<b>LD-003-038</b>	SHAMBAUGH Häkchen, 45° abgewinkelt, 0.4mm <i>SHAMBAUGH hook, 45° angled, 0.4mm</i>
<b>LD-003-039</b>	SHAMBAUGH Häkchen, 45° abgewinkelt, 0.5mm <i>SHAMBAUGH hook, 45° angled, 0.5mm</i>
<b>LD-003-040</b>	SHAMBAUGH Häkchen, 45° abgewinkelt, 0.6mm <i>SHAMBAUGH hook, 45° angled, 0.6mm</i>
<b>LD-003-041</b>	SHAMBAUGH Häkchen, 45° abgewinkelt, 0.8mm <i>SHAMBAUGH hook, 45° angled, 0.8mm</i>
<b>LD-003-042</b>	SHAMBAUGH Häkchen, 45° abgewinkelt, 1.0mm <i>SHAMBAUGH hook, 45° angled, 1.0mm</i>
<b>LD-003-043</b>	SHAMBAUGH Häkchen, 45° abgewinkelt, 1.2mm <i>SHAMBAUGH hook, 45° angled, 1.2mm</i>
<b>LD-003-044</b>	SHAMBAUGH Häkchen, 45° abgewinkelt, 1.5mm <i>SHAMBAUGH hook, 45° angled, 1.5mm</i>
<b>LD-003-045</b>	SHAMBAUGH Häkchen, 45° abgewinkelt, 2.0mm <i>SHAMBAUGH hook, 45° angled, 2.0mm</i>
<b>LD-003-046</b>	SHAMBAUGH Häkchen, 45° abgewinkelt, 2.5mm <i>SHAMBAUGH hook, 45° angled, 2.5mm</i>
<b>LD-003-089</b>	SHAMBAUGH Häkchen, 25° abgewinkelt, 0.3mm <i>SHAMBAUGH hook, 25° angled, 0.3mm</i>
<b>LD-003-090</b>	SHAMBAUGH Häkchen, 25° abgewinkelt, 0.6mm <i>SHAMBAUGH hook, 25° angled, 0.6mm</i>
<b>LD-003-091</b>	SHAMBAUGH Häkchen, 25° abgewinkelt, 1.0mm <i>SHAMBAUGH hook, 25° angled, 1.0mm</i>
<b>LD-003-092</b>	SHAMBAUGH Häkchen, retrograd, 0.5mm <i>SHAMBAUGH hook, retrograd, 0.5mm</i>
<b>LD-003-093</b>	SHAMBAUGH Häkchen, retrograd, 1.0mm <i>SHAMBAUGH hook, retrograd, 1.0mm</i>



**LD-003-014**  
bis / to  
**LD-003-093**

<b>Bestell-Nr.</b> <b>Ordering no.</b>	<b>Bezeichnung</b> <b>Description</b>	
<b>LD-003-400</b>	Mikro Häkchen, kniegebogen, 90° abgewinkelt nach hinten, 0.3mm <i>Micro hook, bended, 90° angled backward, 0.3mm</i>	
<b>LD-003-401</b>	Mikro Häkchen, kniegebogen, 90° abgewinkelt nach hinten, 0.6mm <i>Micro hook, bended, 90° angled backward, 0.6mm</i>	
<b>LD-003-402</b>	Mikro Häkchen, kniegebogen, 90° abgewinkelt nach hinten, 1.0mm <i>Micro hook, bended, 90° angled backward, 1.0mm</i>	
<b>LD-003-403</b>	Mikro Häkchen, kniegebogen, 90° abgewinkelt nach vorne, 0.3mm <i>Micro hook, bended, 90° angled forward, 0.3mm</i>	
<b>LD-003-404</b>	Mikro Häkchen, kniegebogen, 90° abgewinkelt nach vorne, 0.6mm <i>Micro hook, bended, 90° angled forward, 0.6mm</i>	
<b>LD-003-405</b>	Mikro Häkchen, kniegebogen, 90° abgewinkelt nach vorne, 1.0mm <i>Micro hook, bended, 90° angled forward, 1.0mm</i>	
<b>LD-003-406</b>	Mikro Häkchen, kniegebogen, abgewinkelt retrograd nach hinten, 0.5mm <i>Micro hook, bended, angled retrograde backward, 0.5mm</i>	
<b>LD-003-407</b>	Mikro Häkchen, kniegebogen, abgewinkelt retrograd nach hinten, 1.0mm <i>Micro hook, bended, angled retrograde backward, 1.0mm</i>	
<b>LD-003-408</b>	Mikro Häkchen, kniegebogen, abgewinkelt retrograd nach vorne, 0.5mm <i>Micro hook, bended, angled retrograde forward, 0.5mm</i>	
<b>LD-003-409</b>	Mikro Häkchen, kniegebogen, abgewinkelt retrograd nach vorne, 1.0mm <i>Micro hook, bended, angled retrograde forward, 1.0mm</i>	
<b>LD-003-410</b>	Mikro Häkchen, kniegebogen, 25° abgewinkelt nach hinten, 0.3mm <i>Micro hook, bended, 25° angled backward, 0.3mm</i>	
<b>LD-003-411</b>	Mikro Häkchen, kniegebogen, 25° abgewinkelt nach hinten, 0.6mm <i>Micro hook, bended, 25° angled backward, 0.6mm</i>	
<b>LD-003-412</b>	Mikro Häkchen, kniegebogen, 25° abgewinkelt nach hinten, 1.0mm <i>Micro hook, bended, 25° angled backward, 1.0mm</i>	
<b>LD-003-413</b>	Mikro Häkchen, kniegebogen, 25° abgewinkelt nach vorne, 0.3mm <i>Micro hook, bended, 25° angled forward, 0.3mm</i>	
<b>LD-003-414</b>	Mikro Häkchen, kniegebogen, 25° abgewinkelt nach vorne, 0.6mm <i>Micro hook, bended, 25° angled forward, 0.6mm</i>	
<b>LD-003-415</b>	Mikro Häkchen, kniegebogen, 25° abgewinkelt nach vorne, 1.0mm <i>Micro hook, bended, 25° angled forward, 1.0mm</i>	
<b>LD-003-416</b>	Mikro Häkchen, kniegebogen, 45° abgewinkelt nach hinten, 0.3mm <i>Micro hook, bended, 45° angled backward, 0.3mm</i>	
<b>LD-003-417</b>	Mikro Häkchen, kniegebogen, 45° abgewinkelt nach hinten, 0.6mm <i>Micro hook, bended, 45° angled backward, 0.6mm</i>	
<b>LD-003-418</b>	Mikro Häkchen, kniegebogen, 45° abgewinkelt nach hinten, 1.0mm <i>Micro hook, bended, 45° angled backward, 1.0mm</i>	
<b>LD-003-416</b>	Mikro Häkchen, kniegebogen, 45° abgewinkelt nach vorne, 0.3mm <i>Micro hook, bended, 45° angled forward, 0.3mm</i>	
<b>LD-003-417</b>	Mikro Häkchen, kniegebogen, 45° abgewinkelt nach vorne, 0.6mm <i>Micro hook, bended, 45° angled forward, 0.6mm</i>	
<b>LD-003-418</b>	Mikro Häkchen, kniegebogen, 45° abgewinkelt nach vorne, 1.0mm <i>Micro hook, bended, 45° angled forward, 1.0mm</i>	



**LD-003-400**  
bis / to  
**LD-003-418**

**LD-006-001**  
 bis / to  
**LD-006-004**

**LD-006-008**  
 bis / to  
**LD-006-011**

**LD-006-016**  
 bis / to  
**LD-006-018**

**LD-006-005**  
 bis / to  
**LD-006-007**

**LD-006-019**

**LD-006-015**

Bestell-Nr. Ordering no.	Bezeichnung Description
<b>LD-006-001</b>	BILLEAU Ohrschlinge, gerade, Fig. 1, 16.5cm <i>BILLEAU ear loop, straight, fig. 1, 16.5cm</i>
<b>LD-006-002</b>	BILLEAU Ohrschlinge, gerade, Fig. 2, 16.5cm <i>BILLEAU ear loop, straight, fig. 2, 16.5cm</i>
<b>LD-006-003</b>	BILLEAU Ohrschlinge, gerade, Fig. 3, 16.5cm <i>BILLEAU ear loop, straight, fig. 3, 16.5cm</i>
<b>LD-006-004</b>	BILLEAU Ohrschlinge, gerade, Fig. 0, 16.5cm <i>BILLEAU ear loop, straight, fig. 0, 16.5cm</i>
<b>LD-006-005</b>	SNELLEN Ohrschlinge, gebogen, gerieft, Fig. 1, 15.0cm <i>SNELLEN ear loop, curved, serrated, fig. 1, 15.0cm</i>
<b>LD-006-006</b>	SNELLEN Ohrschlinge, gebogen, gerieft, Fig. 2, 15.0cm <i>SNELLEN ear loop, curved, serrated, fig. 2, 15.0cm</i>
<b>LD-006-007</b>	SNELLEN Ohrschlinge, gebogen, gerieft, Fig. 3, 15.0cm <i>SNELLEN ear loop, curved, serrated, fig. 3, 15.0cm</i>
<b>LD-006-008</b>	SHAPLEIGH Ohrschlinge, gebogen, gerieft, Fig. 1, 16.5cm <i>SHAPLEIGH ear loop, curved, serrated, fig. 1, 16.5cm</i>
<b>LD-006-009</b>	SHAPLEIGH Ohrschlinge, gebogen, gerieft, Fig. 2, 16.5cm <i>SHAPLEIGH ear loop, curved, serrated, fig. 2, 16.5cm</i>
<b>LD-006-010</b>	SHAPLEIGH Ohrschlinge, gerade, gerieft, Fig. 1, 16.5cm <i>SHAPLEIGH ear loop, straight, serrated, fig. 1, 16.5cm</i>
<b>LD-006-011</b>	SHAPLEIGH Ohrschlinge, gerade, gerieft, Fig. 2, 16.5cm <i>SHAPLEIGH ear loop, straight, serrated, fig. 2, 16.5cm</i>
<b>LD-006-015</b>	LANGENBECK Ohrschlinge, gebogen, 13cm <i>LANGENBECK ear loop, curved, 13cm</i>
<b>LD-006-016</b>	WEBER-LOCH Ohrschlinge, gerade, Fig. 0, 16cm <i>WEBER-LOCH ear loop, straight, fig. 0, 16cm</i>
<b>LD-006-017</b>	WEBER-LOCH Ohrschlinge, gerade, Fig. 0, 16cm <i>WEBER-LOCH ear loop, straight, fig. 0, 16cm</i>
<b>LD-006-018</b>	WEBER-LOCH Ohrschlinge, gerade, Fig. 0, 16cm <i>WEBER-LOCH ear loop, straight, fig. 0, 16cm</i>
<b>LD-006-019</b>	COXETER Ohrschlinge, stumpf, 14.5cm <i>COXETER ear loop, blunt, 14.5cm</i>



**LD-003-100**  
bis / to  
**LD-003-107**



**LD-003-108**  
bis / to  
**LD-003-115**

<b>Bestell-Nr. Ordering no.</b>	<b>Bezeichnung Description</b>
<b>LD-003-100</b>	BUCK Ohrkürette, gebogen, scharf, Fig. 000 <i>BUCK ear curette, curved, sharp, fig. 000</i>
<b>LD-003-101</b>	BUCK Ohrkürette, gebogen, scharf, Fig. 00 <i>BUCK ear curette, curved, sharp, fig. 00</i>
<b>LD-003-102</b>	BUCK Ohrkürette, gebogen, scharf, Fig. 0 <i>BUCK ear curette, curved, sharp, fig. 0</i>
<b>LD-003-103</b>	BUCK Ohrkürette, gebogen, scharf, Fig. 1 <i>BUCK ear curette, curved, sharp, fig. 1</i>
<b>LD-003-104</b>	BUCK Ohrkürette, gebogen, scharf, Fig. 2 <i>BUCK ear curette, curved, sharp, fig. 2</i>
<b>LD-003-105</b>	BUCK Ohrkürette, gebogen, scharf, Fig. 3 <i>BUCK ear curette, curved, sharp, fig. 3</i>
<b>LD-003-106</b>	BUCK Ohrkürette, gebogen, scharf, Fig. 4 <i>BUCK ear curette, curved, sharp, fig. 4</i>
<b>LD-003-107</b>	BUCK Ohrkürette, gebogen, scharf, Fig. 5 <i>BUCK ear curette, curved, sharp, fig. 5</i>
<b>LD-003-108</b>	BUCK Ohrkürette, gebogen, stumpf, Fig. 000 <i>BUCK ear curette, curved, blunt, fig. 000</i>
<b>LD-003-109</b>	BUCK Ohrkürette, gebogen, stumpf, Fig. 00 <i>BUCK ear curette, curved, blunt, fig. 00</i>
<b>LD-003-110</b>	BUCK Ohrkürette, gebogen, stumpf, Fig. 0 <i>BUCK ear curette, curved, blunt, fig. 0</i>
<b>LD-003-111</b>	BUCK Ohrkürette, gebogen, stumpf, Fig. 1 <i>BUCK ear curette, curved, blunt, fig. 1</i>
<b>LD-003-112</b>	BUCK Ohrkürette, gebogen, stumpf, Fig. 2 <i>BUCK ear curette, curved, blunt, fig. 2</i>
<b>LD-003-113</b>	BUCK Ohrkürette, gebogen, stumpf, Fig. 3 <i>BUCK ear curette, curved, blunt, fig. 3</i>
<b>LD-003-114</b>	BUCK Ohrkürette, gebogen, stumpf, Fig. 4 <i>BUCK ear curette, curved, blunt, fig. 4</i>
<b>LD-003-115</b>	BUCK Ohrkürette, gebogen, stumpf, Fig. 5 <i>BUCK ear curette, curved, blunt, fig. 5</i>



**LD-003-116**  
bis / to  
**LD-003-123**



**LD-003-124**  
bis / to  
**LD-003-131**



**LD-006-020**

<b>Bestell-Nr.</b> <b>Ordering no.</b>	<b>Bezeichnung</b> <b>Description</b>
<b>LD-003-116</b>	BUCK Ohrkürette, gerade, scharf, Fig. 000 <i>BUCK ear curette, straight, sharp, fig. 000</i>
<b>LD-003-117</b>	BUCK Ohrkürette, gerade, scharf, Fig. 00 <i>BUCK ear curette, straight, sharp, fig. 00</i>
<b>LD-003-118</b>	BUCK Ohrkürette, gerade, scharf, Fig. 0 <i>BUCK ear curette, straight, sharp, fig. 0</i>
<b>LD-003-119</b>	BUCK Ohrkürette, gerade, scharf, Fig. 1 <i>BUCK ear curette, straight, sharp, fig. 1</i>
<b>LD-003-120</b>	BUCK Ohrkürette, gerade, scharf, Fig. 2 <i>BUCK ear curette, straight, sharp, fig. 2</i>
<b>LD-003-121</b>	BUCK Ohrkürette, gerade, scharf, Fig. 3 <i>BUCK ear curette, straight, sharp, fig. 3</i>
<b>LD-003-122</b>	BUCK Ohrkürette, gerade, scharf, Fig. 4 <i>BUCK ear curette, straight, sharp, fig. 4</i>
<b>LD-003-123</b>	BUCK Ohrkürette, gerade, scharf, Fig. 5 <i>BUCK ear curette, straight, sharp, fig. 5</i>
<b>LD-003-124</b>	BUCK Ohrkürette, gerade, stumpf, Fig. 000 <i>BUCK ear curette, straight, blunt, fig. 000</i>
<b>LD-003-125</b>	BUCK Ohrkürette, gerade, stumpf, Fig. 00 <i>BUCK ear curette, straight, blunt, fig. 00</i>
<b>LD-003-126</b>	BUCK Ohrkürette, gerade, stumpf, Fig. 0 <i>BUCK ear curette, straight, blunt, fig. 0</i>
<b>LD-003-127</b>	BUCK Ohrkürette, gerade, stumpf, Fig. 1 <i>BUCK ear curette, straight, blunt, fig. 1</i>
<b>LD-003-128</b>	BUCK Ohrkürette, gerade, stumpf, Fig. 2 <i>BUCK ear curette, straight, blunt, fig. 2</i>
<b>LD-003-129</b>	BUCK Ohrkürette, gerade, stumpf, Fig. 3 <i>BUCK ear curette, straight, blunt, fig. 3</i>
<b>LD-003-130</b>	BUCK Ohrkürette, gerade, stumpf, Fig. 4 <i>BUCK ear curette, straight, blunt, fig. 4</i>
<b>LD-003-131</b>	BUCK Ohrkürette, gerade, stumpf, Fig. 5 <i>BUCK ear curette, straight, blunt, fig. 5</i>
<b>LD-006-020</b>	ANTOLI-CANDELA Ohrkürette, 15cm <i>ANTOLI-CANDELA ear curette, 15cm</i>





**LD-008-011**  
bis / to  
**LD-008-018**



**LD-008-001**  
bis / to  
**LD-008-010**



**LD-003-001**  
bis / to  
**LD-003-002-1**

Bestell-Nr. Ordering no.	Bezeichnung Description
<b>LD-003-001</b>	HOUSE Doppellöffel, mittel, 1.5/1.8, 15cm <i>HOUSE double spoon, medium, 1.5/1.8mm, 15cm</i>
<b>LD-003-001-1</b>	HOUSE Doppellöffel, mittel, 1.0/1.2, stark gebogen, 15cm <i>HOUSE double spoon, medium, 1.5/1.8mm, strong curved, 15cm</i>
<b>LD-003-002</b>	HOUSE Doppellöffel, mittel, 1.0/1.2, 15cm <i>HOUSE double spoon, medium, 1.0/1.2mm, 15cm</i>
<b>LD-003-002-1</b>	HOUSE Doppellöffel, mittel, 1.0/1.2, stark gebogen, 15cm <i>HOUSE double spoon, medium, 1.0/1.2mm, strong curved, 15cm</i>
<b>LD-008-001</b>	SPRATT scharfer Löffel, 16cm, Fig. 0000 <i>SPRATT sharp curette, 16cm, fig. 0000</i>
<b>LD-008-002</b>	SPRATT scharfer Löffel, 16cm, Fig. 000 <i>SPRATT sharp curette, 16cm, fig. 000</i>
<b>LD-008-003</b>	SPRATT scharfer Löffel, 16cm, Fig. 00 <i>SPRATT sharp curette, 16cm, fig. 00</i>
<b>LD-008-004</b>	SPRATT scharfer Löffel, 16cm, Fig. 0 <i>SPRATT sharp curette, 16cm, fig. 0</i>
<b>LD-008-005</b>	SPRATT scharfer Löffel, 16cm, Fig. 1 <i>SPRATT sharp curette, 16cm, fig. 1</i>
<b>LD-008-006</b>	SPRATT scharfer Löffel, 16cm, Fig. 2 <i>SPRATT sharp curette, 16cm, fig. 2</i>
<b>LD-008-007</b>	SPRATT scharfer Löffel, 16cm, Fig. 3 <i>SPRATT sharp curette, 16cm, fig. 3</i>
<b>LD-008-008</b>	SPRATT scharfer Löffel, 16cm, Fig. 4 <i>SPRATT sharp curette, 16cm, fig. 4</i>
<b>LD-008-009</b>	SPRATT scharfer Löffel, 16cm, Fig. 5 <i>SPRATT sharp curette, 16cm, fig. 5</i>
<b>LD-008-010</b>	SPRATT scharfer Löffel, 16cm, Fig. 6 <i>SPRATT sharp curette, 16cm, fig. 6</i>
<b>LD-008-011</b>	LEMPERT scharfer Löffel, 20cm, oval, Fig. 000000 <i>LEMPERT sharp curette, 20cm, oval, fig. 000000</i>
<b>LD-008-012</b>	LEMPERT scharfer Löffel, 20cm, oval, Fig. 00000 <i>LEMPERT sharp curette, 20cm, oval, fig. 00000</i>
<b>LD-008-013</b>	LEMPERT scharfer Löffel, 20cm, oval, Fig. 0000 <i>LEMPERT sharp curette, 20cm, oval, fig. 0000</i>
<b>LD-008-014</b>	LEMPERT scharfer Löffel, 20cm, oval, Fig. 000 <i>LEMPERT sharp curette, 20cm, oval, fig. 000</i>
<b>LD-008-015</b>	LEMPERT scharfer Löffel, 20cm, oval, Fig. 00 <i>LEMPERT sharp curette, 20cm, oval, fig. 00</i>
<b>LD-008-016</b>	LEMPERT scharfer Löffel, 20cm, oval, Fig. 0 <i>LEMPERT sharp curette, 20cm, oval, fig. 0</i>
<b>LD-008-017</b>	LEMPERT scharfer Löffel, 20cm, oval, Fig. 1 <i>LEMPERT sharp curette, 20cm, oval, fig. 1</i>
<b>LD-008-018</b>	LEMPERT scharfer Löffel, 20cm, oval, Fig. 2 <i>LEMPERT sharp curette, 20cm, oval, fig. 2</i>

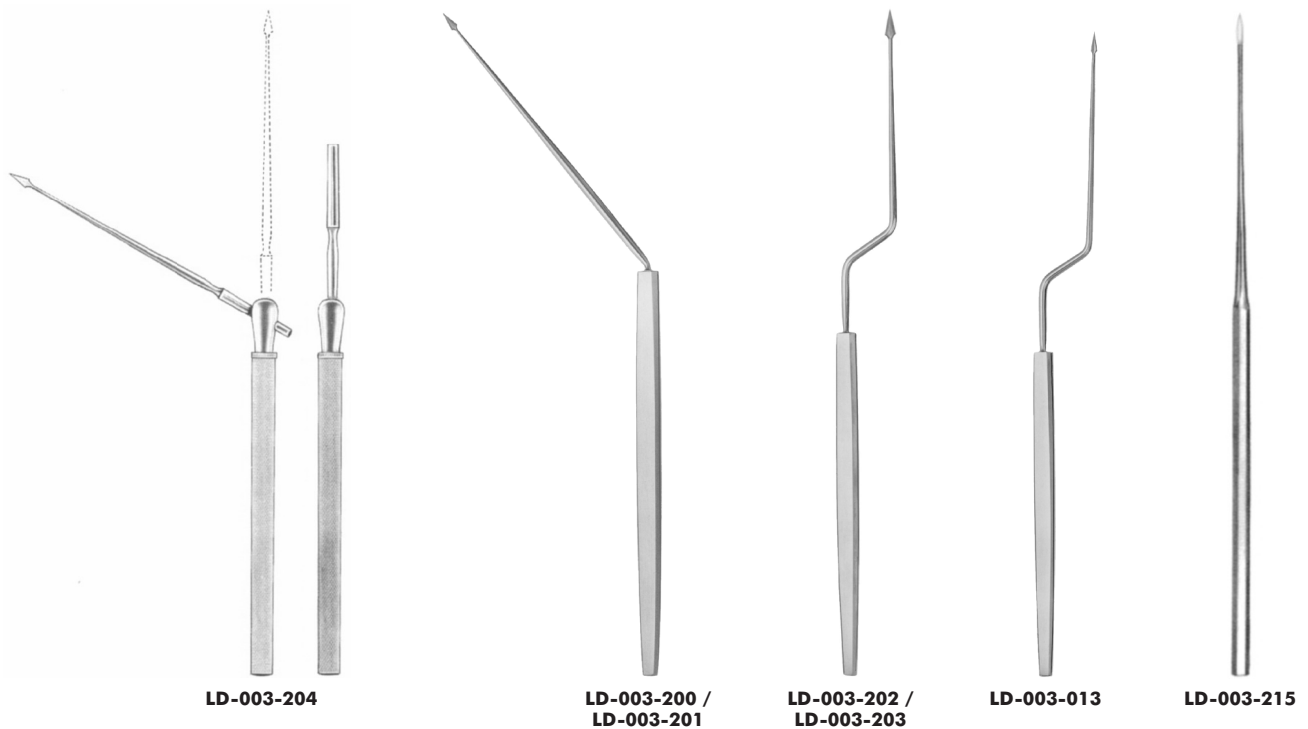

Bestell-Nr. Ordering no.	Bezeichnung Description
LD-003-013	POLITZER Parazentesenadel, zart, 16cm <i>POLITZER Tympanum perforator, fine, 16cm</i>
LD-003-200	POLITZER Parazentesenadel, kniegebogen, 16cm <i>POLITZER tympanum perforator, angled, 16cm</i>
LD-003-201	POLITZER Parazentesenadel, kniegebogen, waagrecht, 16cm <i>POLITZER tympanum perforator, angled, horizontally, 16cm</i>
LD-003-202	LUCAE Parazentesenadel, bajonettgebogen, 18.5cm <i>LUCAE tympanum perforator, bayonett angled, 18.5cm</i>
LD-003-203	LUCAE Parazentesenadel, bajonettgebogen, waagrecht, 18.5cm <i>LUCAE tympanum perforator, bayonett angled, horizontally, 18.5cm</i>
LD-003-204	POLITZER Parazentesenadel zum Umstecken <i>POLITZER tympanum perforator exchangeable</i>
LD-003-215	Parazentesenadel, gerade, 16.5cm <i>Tympanum perforator, straight, 16.5cm</i>



LD-003-205



LD-003-209



LD-003-210



LD-003-211



LD-003-206



LD-003-207



LD-003-208

Bestell-Nr. Ordering no.	Bezeichnung Description
LD-003-205	HARTMANN Handgriff für Instrumente LD-003-206 bis LD-003-212 <i>HARTMANN handle for instruments LD-003-206 to LD-003-212</i>
LD-003-206	Parazentesenadel-Aufsatz für HARTMANN Handgriff <i>Tympanum perforator tip for HARTMANN handle</i>
LD-003-207	Parazentesenadel-Aufsatz für HARTMANN Handgriff <i>Tympanum perforator tip for HARTMANN handle</i>
LD-003-208	Parazentesenadel (Sichelmesser) Aufsatz für HARTMANN Handgriff <i>Tympanum perforator (sickle knife) for HARTMANN handle</i>
LD-003-209	Parazentesenadel (Lanzennmesser) Aufsatz für HARTMANN Handgriff <i>Tympanum perforator (lancet knife) for HARTMANN handle</i>
LD-003-210	Parazentesenadel (Haken) Aufsatz für HARTMANN Handgriff <i>Tympanum perforator (hook) for HARTMANN handle</i>
LD-003-211	Parazentesenadel (Kürette) Aufsatz für HARTMANN Handgriff <i>Tympanum perforator (curette) for HARTMANN handle</i>
LD-003-212	Parazentesenadel (Löffel) Aufsatz für HARTMANN Handgriff <i>Tympanum perforator (spoon) for HARTMANN handle</i>

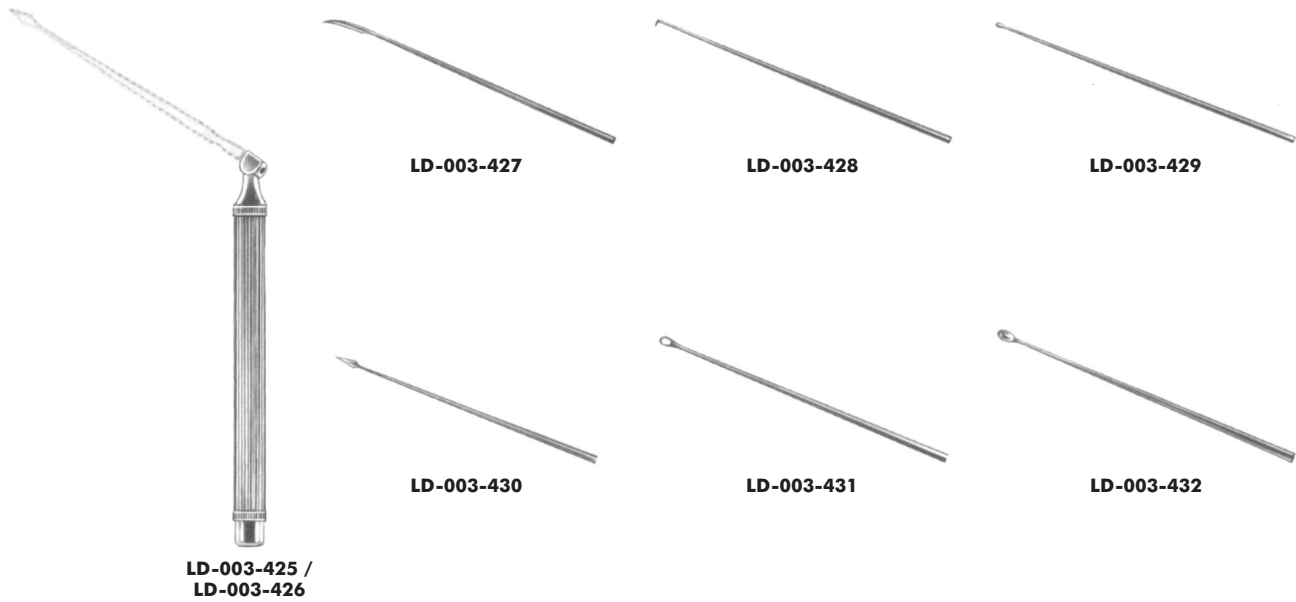

<b>Bestell-Nr.</b> <b>Ordering no.</b>	<b>Bezeichnung</b> <b>Description</b>
<b>LD-003-425</b>	SPRAGUE Ohrbestecksatz <i>SPRAGUE complete ear set</i>
<b>LD-003-426</b>	Handgriff für SPRAGUE Ohrbestecksatz <i>Handle for SPRAGUE ear set</i>
<b>LD-003-427</b>	Messer für SPRAGUE Ohrbestecksatz <i>Knife for SPRAGUE ear set</i>
<b>LD-003-428</b>	Haken für SPRAGUE Ohrbestecksatz <i>Hook for SPRAGUE ear set</i>
<b>LD-003-429</b>	Sonde für SPRAGUE Ohrbestecksatz <i>Probe for SPRAGUE ear set</i>
<b>LD-003-430</b>	Nadel für SPRAGUE Ohrbestecksatz <i>Needle for SPRAGUE ear set</i>
<b>LD-003-431</b>	Schlinge für SPRAGUE Ohrbestecksatz <i>Loop for SPRAGUE ear set</i>
<b>LD-003-432</b>	Löffel für SPRAGUE Ohrbestecksatz <i>Spoon for SPRAGUE ear set</i>

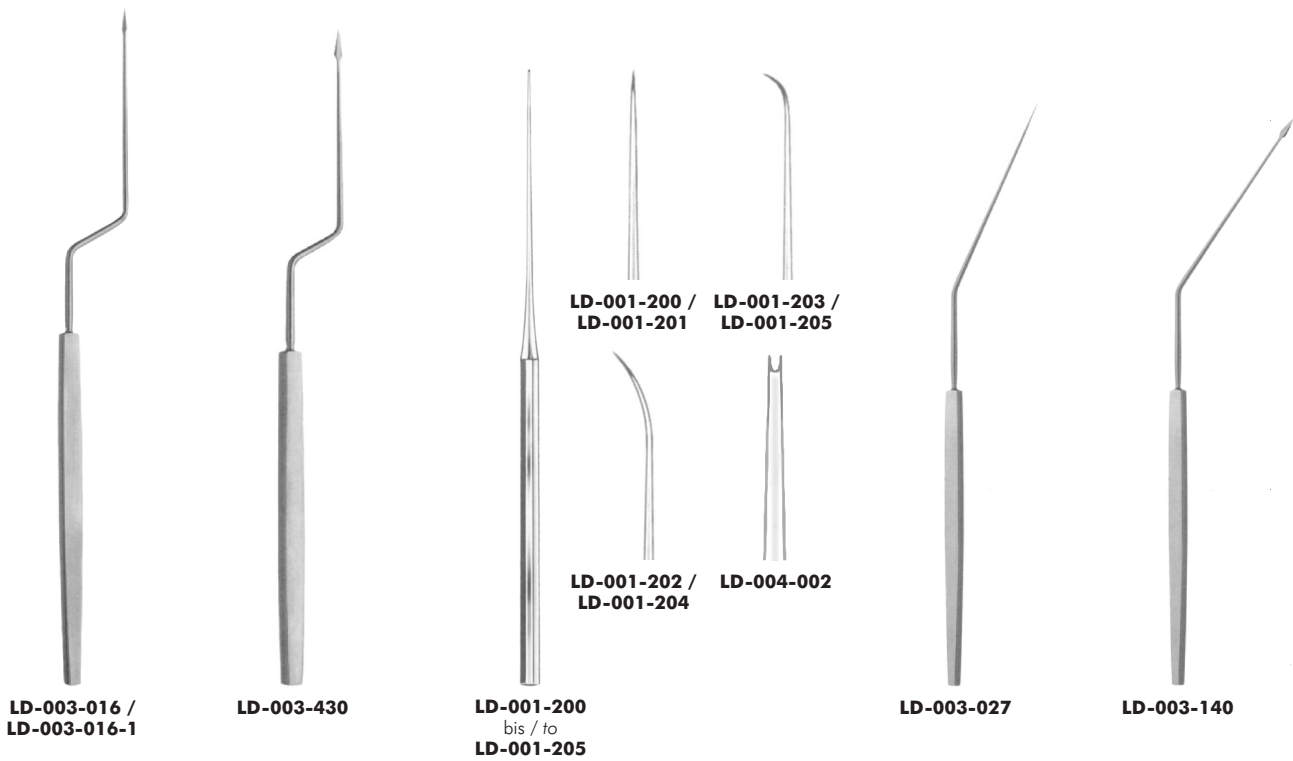

Bestell-Nr. Ordering no.	Bezeichnung Description
LD-001-189	AGNEW Nadel, 17.5cm <i>AGNEW needle, 17.5cm</i>
LD-001-190	POLITZER Nadel, gerade, 18cm <i>POLITZER needle, straight, 18cm</i>
LD-001-200	WULLSTEIN Nadel, gerade, scharf, 16.5cm <i>WULLSTEIN needle, straight, sharp, 16.5cm</i>
LD-001-201	WULLSTEIN Nadel, gerade, stumpf, 16.5cm <i>WULLSTEIN needle, straight, blunt, 16.5cm</i>
LD-001-202	WULLSTEIN Nadel, leicht gebogen, scharf, 16.5cm <i>WULLSTEIN needle, slight curved, sharp, 16.5cm</i>
LD-001-203	WULLSTEIN Nadel, stark gebogen, scharf, 16.5cm <i>WULLSTEIN needle, strong curved, sharp, 16.5cm</i>
LD-001-204	WULLSTEIN Nadel, leicht gebogen, stumpf, 16.5cm <i>WULLSTEIN needle, slight curved, blunt, 16.5cm</i>
LD-001-205	WULLSTEIN Nadel, leicht gebogen, stumpf, 16.5cm <i>WULLSTEIN needle, slight curved, blunt, 16.5cm</i>
LD-003-016	LUCAE Ohrnadel, senkrecht gebogen, 19cm <i>LUCAE ear needle, vertical curved, 19cm</i>
LD-003-016-1	LUCAE Ohrnadel, waagrecht gebogen, 19cm <i>LUCAE ear needle, horizontal curved, 19cm</i>
LD-003-027	BARBARA Ohrnadel mit abgewinkelten Schaft, 16cm <i>BARBARA ear needle with angled shaft, 16cm</i>
LD-003-140	LUCAE Ohrnadel für Kinder, senkrecht gebogen, 16cm <i>LUCAE ear needle for children, vertical curved, 16cm</i>
LD-004-002	PLESTER Führungsgabel, 16.5cm <i>PLESTER leading fork, 16.5cm</i>

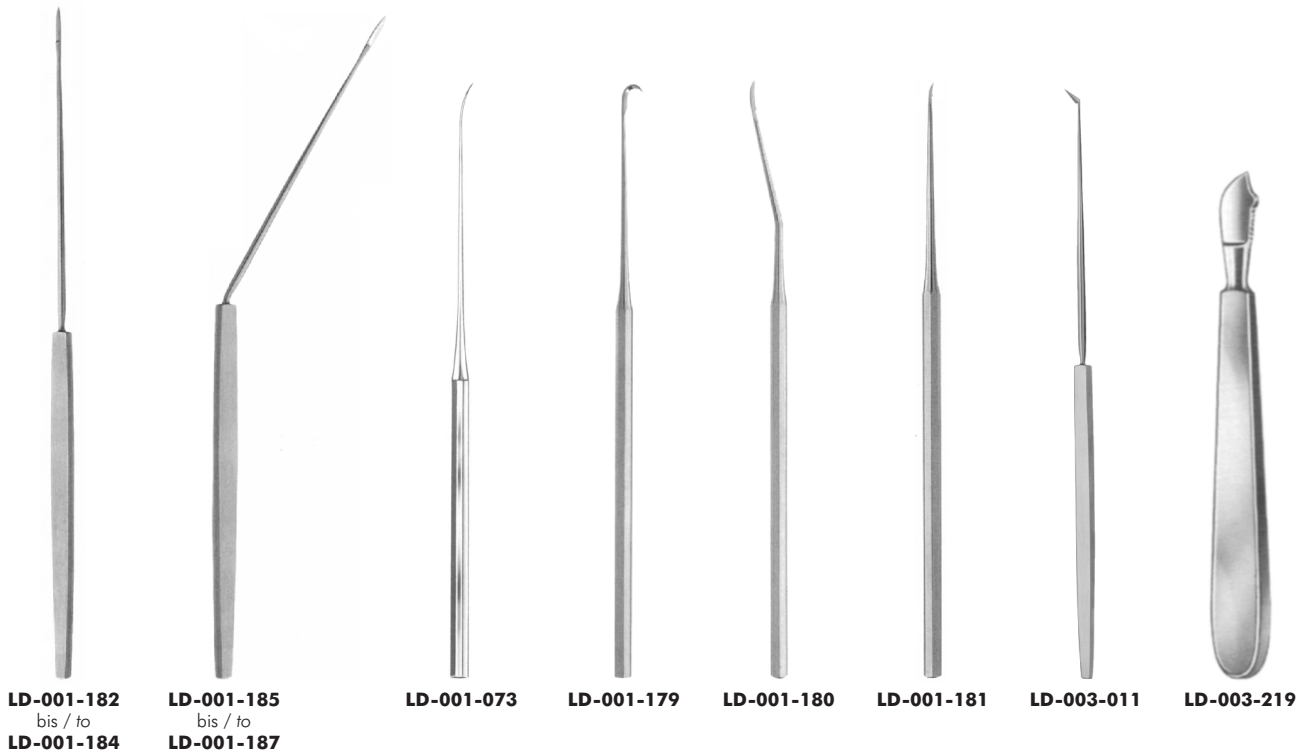

Bestell-Nr. Ordering no.	Bezeichnung Description
<b>LD-001-073</b>	FISCH Neurektomie-Messer, 16cm <i>FISCH neurectomie knife, 16cm</i>
<b>LD-001-179</b>	GOLFSTOCK Sichelmesser, 16cm <i>GOLFSTOCK sickle knife, 16cm</i>
<b>LD-001-180</b>	SCHUHKNECHT Sichelmesser, nach hinten gebogen, 16cm <i>SCHUHKNECHT sickle knife, curved backwards, 16cm</i>
<b>LD-001-181</b>	TAPP Sichelmesser, 3x1mm, 16cm <i>TAPP sickle knife, 3x1mm, 16cm</i>
<b>LD-001-182</b>	SEXTON Ohrmesser, Fig. 1, 18cm <i>SEXTON ear knife, fig. 1, 18cm</i>
<b>LD-001-183</b>	SEXTON Ohrmesser, Fig. 2, 18cm <i>SEXTON ear knife, fig. 2, 18cm</i>
<b>LD-001-184</b>	SEXTON Ohrmesser, Fig. 3, 18cm <i>SEXTON ear knife, fig. 3, 18cm</i>
<b>LD-001-185</b>	SEXTON Ohrmesser, gebogen, Fig. 1, 18cm <i>SEXTON ear knife, curved, fig. 1, 18cm</i>
<b>LD-001-186</b>	SEXTON Ohrmesser, gebogen, Fig. 2, 18cm <i>SEXTON ear knife, curved, fig. 2, 18cm</i>
<b>LD-001-187</b>	SEXTON Ohrmesser, gebogen, Fig. 3, 18cm <i>SEXTON ear knife, curved, fig. 3, 18cm</i>
<b>LD-003-011</b>	HOUSE Lanzettenmesser, 45° abgewinkelt, 2x3mm, 16cm <i>HOUSE lancet knife, 45° angled, 2x3mm, 16cm</i>
<b>LD-003-219</b>	MUCK Periostmesser, 13cm <i>MUCK periostknife, 13cm</i>



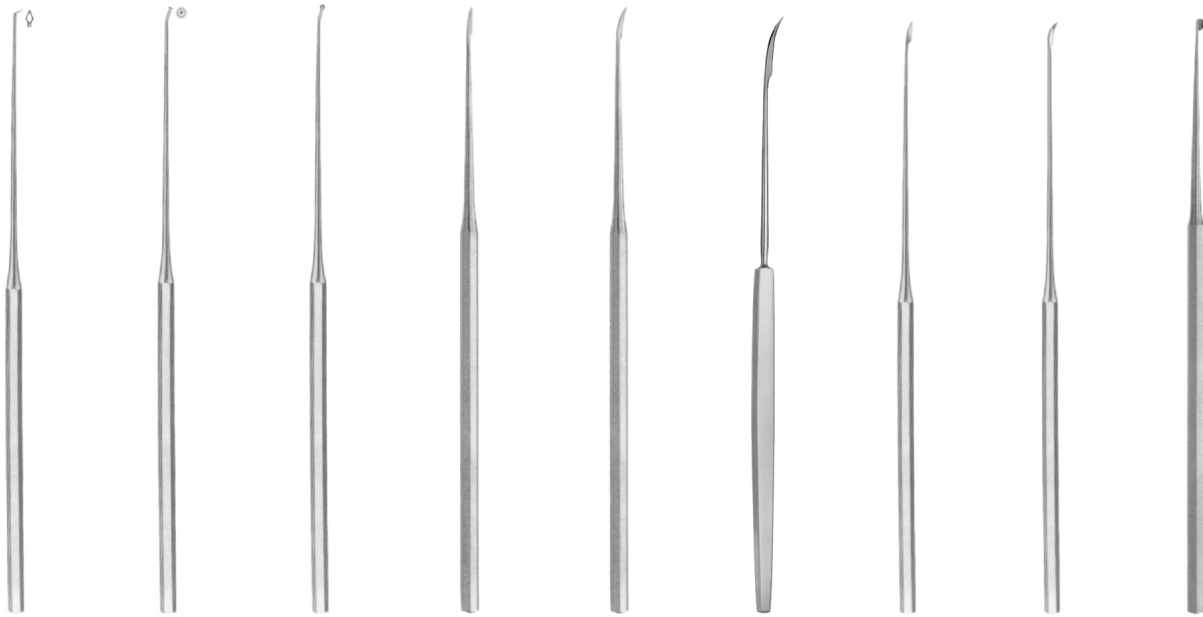

LD-003-077    LD-003-078    LD-003-079    LD-003-080    LD-003-080-1    LD-003-012    LD-003-019    LD-003-020    LD-003-021

Bestell-Nr. Ordering no.	Bezeichnung Description
LD-003-012	POLITZER Ohrmesser, gebogen, 16cm <i>POLITZER ear knife, curved, 16cm</i>
LD-003-019	Ohrmesser gerade, 16cm <i>Ear knife, straight, 16cm</i>
LD-003-020	Ohrmesser gebogen, 16cm <i>Ear knife, curved, 16cm</i>
LD-003-021	PLESTER Lappenmesser, 2.4 x 3.5mm, 16cm <i>PLESTER flap knife, 2.4 x 3.5mm, 16cm</i>
LD-003-077	ROSEN Lanzettmesser, 45°, 16.5cm <i>ROSEN lancet knife, 45°, 16.5cm</i>
LD-003-078	SCHUHKNECHT Rollmesser, horizontal, 16.5cm <i>SCHUHKNECHT rollerknife, horizontal, 16.5cm</i>
LD-003-079	SCHUHKNECHT Rollmesser, vertikal, 16.5cm <i>SCHUHKNECHT rollerknife, vertical, 16.5cm</i>
LD-003-080	Sichelmesser, gerade, 16.5cm <i>Sickle knife, straight, 16.5cm</i>
LD-003-080-1	Sichelmesser, leicht gebogen, 16.5cm <i>Sickle knife, slight curved, 16.5cm</i>

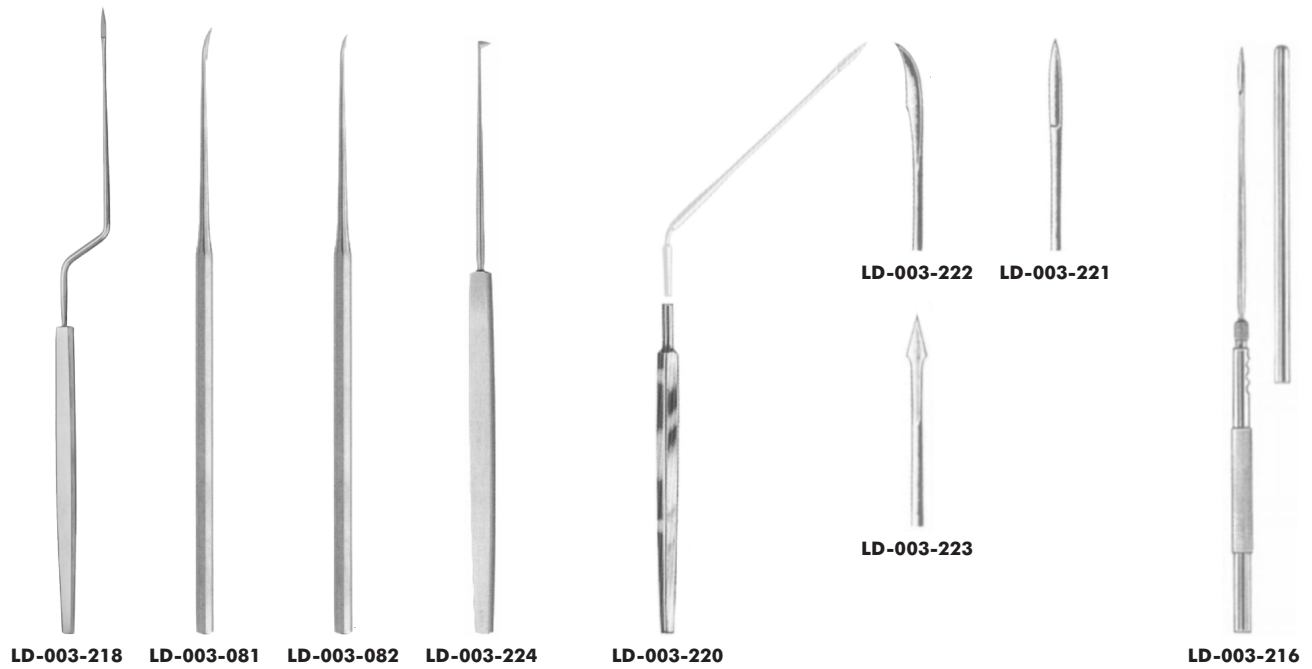

Bestell-Nr. Ordering no.	Bezeichnung Description
LD-003-081	PLESTER Sichelmesser, gebogen, 16.5cm <i>PLESTER sickle knife, curved, 16.5cm</i>
LD-003-082	PLESTER Sichelmesser, gebogen, fein, 16.5cm <i>PLESTER sickle knife, curved, delicate, 16.5cm</i>
LD-003-216	FRIENSER Ohrmesser mit Schutzhülse, 16cm <i>FRIESNER ear knife with protection tube, 16cm</i>
LD-003-218	GERZOG-SEXTON Ohrmesser, 17cm <i>GERZOG SEXTON ear knife, 17cm</i>
LD-003-220	ROYCE Handgriff für Instrumente LD-003-221 bis LD-003-223 <i>ROYCE handle for instruments LD-003-221 -LD-003-223</i>
LD-003-221	ROYCE Messeraufsatz, gerade für ROYCE Handgriff <i>ROYCE knife insert, straight, for ROYCE handle</i>
LD-003-222	ROYCE Sichelmesseraufsatz, für ROYCE Handgriff <i>ROYCE sickle knife insert, for ROYCE handle</i>
LD-003-223	ROYCE Lanzenmesseraufsatz, für ROYCE Handgriff <i>ROYCE lancet knife insert, for ROYCE handle</i>
LD-003-224	POLITZER Ohrmesser, gerade, 16cm <i>POLITZER ear knife, straight, 16cm</i>



**LD-003-030**  
bis / to  
**LD-003-034**



**LD-003-070**  
bis / to  
**LD-003-076**



**LD-003-166**  
bis / to  
**LD-003-168**

Bestell-Nr. Ordering no.	Bezeichnung Description
<b>LD-003-030</b>	ROSEN Rundschnittmesser, 1.0mm, 45°, 16cm <i>ROSEN flap knife, 1.0mm, 45°, 16cm</i>
<b>LD-003-031</b>	ROSEN Rundschnittmesser, 1.4mm, 45°, 16cm <i>ROSEN flap knife, 1.4mm, 45°, 16cm</i>
<b>LD-003-031-1</b>	ROSEN Rundschnittmesser, 1.6mm, 45°, 16cm <i>ROSEN flap knife, 1.6mm, 45°, 16cm</i>
<b>LD-003-032</b>	ROSEN Rundschnittmesser, 2.0mm, 45°, 16cm <i>ROSEN flap knife, 2.0mm, 45°, 16cm</i>
<b>LD-003-033</b>	ROSEN Rundschnittmesser, 2.6mm, 45°, 16cm <i>ROSEN flap knife, 2.6mm, 45°, 16cm</i>
<b>LD-003-033-1</b>	ROSEN Rundschnittmesser, 2.8mm, 45°, 16cm <i>ROSEN flap knife, 2.8mm, 45°, 16cm</i>
<b>LD-003-034</b>	ROSEN Rundschnittmesser, 3.0mm, 45°, 16cm <i>ROSEN flap knife, 3.0mm, 45°, 16cm</i>
<b>LD-003-070</b>	ROSEN Rundschnittmesser, 1.0mm, gerade, 16cm <i>ROSEN flap knife, 1.0mm, straight, 16cm</i>
<b>LD-003-071</b>	ROSEN Rundschnittmesser, 1.4mm, gerade, 16cm <i>ROSEN flap knife, 1.4mm, straight, 16cm</i>
<b>LD-003-072</b>	ROSEN Rundschnittmesser, 1.6mm, gerade, 16cm <i>ROSEN flap knife, 1.6mm, straight, 16cm</i>
<b>LD-003-073</b>	ROSEN Rundschnittmesser, 2.0mm, gerade, 16cm <i>ROSEN flap knife, 2.0mm, straight, 16cm</i>
<b>LD-003-074</b>	ROSEN Rundschnittmesser, 2.6mm, gerade, 16cm <i>ROSEN flap knife, 2.6mm, straight, 16cm</i>
<b>LD-003-075</b>	ROSEN Rundschnittmesser, 2.8mm, gerade, 16cm <i>ROSEN flap knife, 2.8mm, straight, 16cm</i>
<b>LD-003-076</b>	ROSEN Rundschnittmesser, 3.0mm, gerade, 16cm <i>ROSEN flap knife, 3.0mm, straight, 16cm</i>
<b>LD-003-166</b>	Rundschnittmesser, 1.5mm, 90°, 16cm <i>Flap knife, 1.5mm, 90°, 16cm</i>
<b>LD-003-167</b>	Rundschnittmesser, 2.0mm, 90°, 16cm <i>Flap knife, 2.0mm, 90°, 16cm</i>
<b>LD-003-168</b>	Rundschnittmesser, 2.5mm, 90°, 16cm <i>Flap knife, 2.5mm, 90°, 16cm</i>

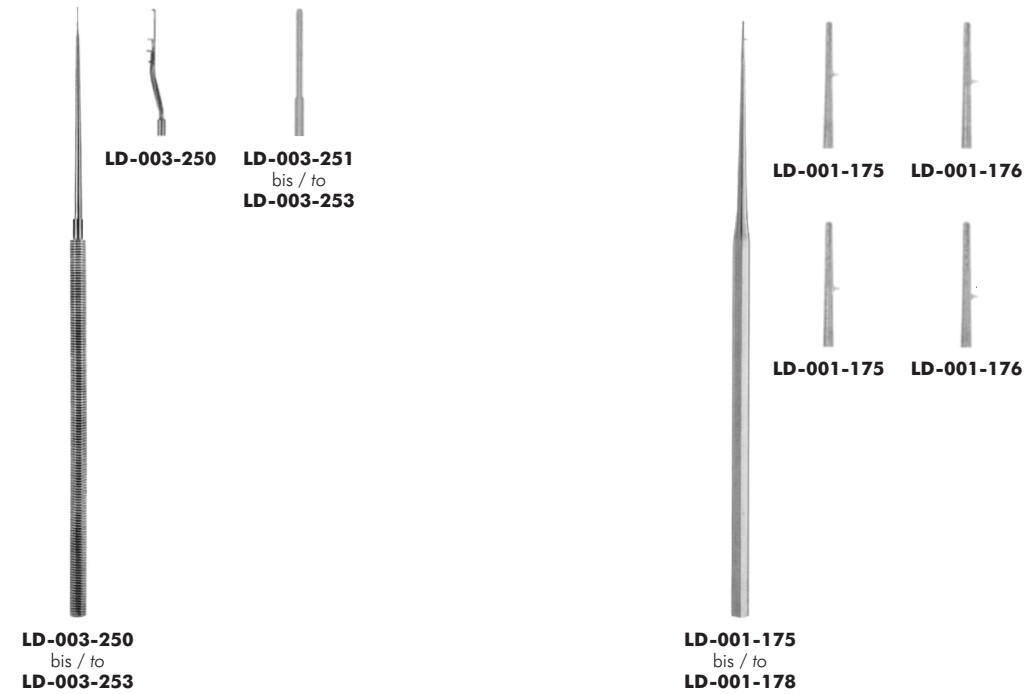

<b>Bestell-Nr.</b> <b>Ordering no.</b>	<b>Bezeichnung</b> <b>Description</b>
<b>LD-001-175</b>	HOUSE Meßsonde, 3.5mm, 16cm <i>HOUSE measuring probe, 3.5mm, 16cm</i>
<b>LD-001-176</b>	HOUSE Meßsonde, 3.5mm, 16cm <i>HOUSE measuring probe, 3.5mm, 16cm</i>
<b>LD-001-177</b>	HOUSE Meßsonde, 3.5mm, 16cm <i>HOUSE measuring probe, 3.5mm, 16cm</i>
<b>LD-001-178</b>	HOUSE Meßsonde, 3.5mm, 16cm <i>HOUSE measuring probe, 3.5mm, 16cm</i>
<b>LD-003-250</b>	FISCH Längen-Meßinstrument, 16.5cm <i>FISCH stapes caliper, 16.5cm</i>
<b>LD-003-251</b>	FISCH Meßzylinder, Ø 0.4mm, 16.5cm <i>FISCH caliper, Ø 0.4mm, 16.5cm</i>
<b>LD-003-252</b>	FISCH Meßzylinder, Ø 0.6mm, 16.5cm <i>FISCH caliper, Ø 0.6mm, 16.5cm</i>
<b>LD-003-253</b>	FISCH Meßzylinder, Ø 0.8mm, 16.5cm <i>FISCH caliper, Ø 0.8mm, 16.5cm</i>

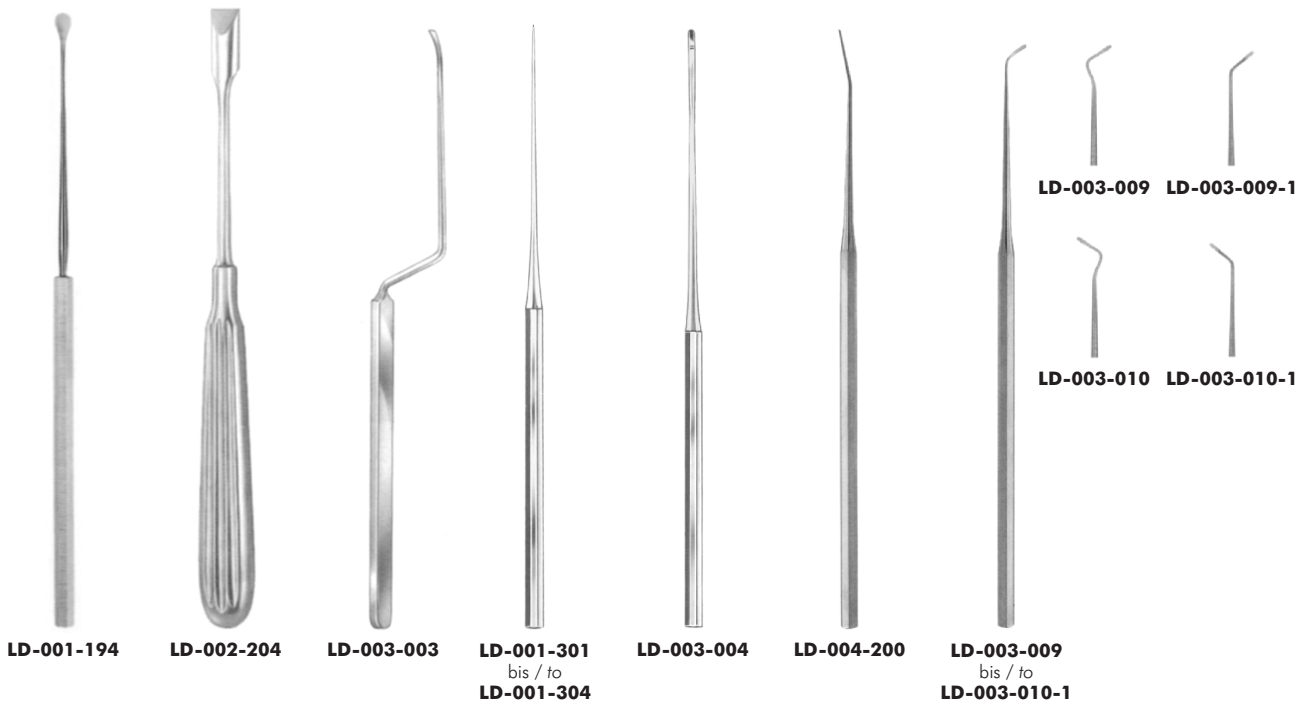

Bestell-Nr. Ordering no.	Bezeichnung Description
LD-001-194	FISCH Dura Elevator, Breite 5mm, 17cm <i>FISCH dura elevator, wide 5mm, 17cm</i>
LD-001-301	FISCH Perforator, Ø 0.3mm, 16cm <i>FISCH perforator, Ø 0.3mm, 16cm</i>
LD-001-302	FISCH Perforator, Ø 0.4mm, 16cm <i>FISCH perforator, Ø 0.4mm, 16cm</i>
LD-001-303	FISCH Perforator, Ø 0.5mm, 16cm <i>FISCH perforator, Ø 0.5mm, 16cm</i>
LD-001-304	FISCH Perforator, Ø 0.6mm, 16cm <i>FISCH perforator, Ø 0.6mm, 16cm</i>
LD-002-204	ADSON Elevator, gerade, 9.0mm breit, 17cm <i>ADSON elevator, gerade, 9.0mm wide, 17cm</i>
LD-003-003	ROSEN Elevatorium, 16cm <i>ROSEN elevator, 16cm</i>
LD-003-004	BEALES Elevatorium, leicht gebogen, 2.0mm breit, 16cm <i>BEALES elevator, slight curved, 2.0mm wide, 16cm</i>
LD-003-009	FISCH Dissektor, doppelt gebogen rechts, 15.5cm <i>FISCH dissector, double curved right, 15.5cm</i>
LD-003-009-1	FISCH Dissektor, doppelt gebogen rechts, 15.5cm <i>FISCH dissector, double curved right, 15.5cm</i>
LD-003-010	FISCH Dissektor, doppelt gebogen links, 15.5cm <i>FISCH dissector, double curved left, 15.5cm</i>
LD-003-010-1	FISCH Dissektor, einfach gebogen links, 15.5cm <i>FISCH dissector, single curved left, 15.5cm</i>
LD-004-200	Elevator, leicht gebogen, 1.0mm breit, 16cm <i>Elevator, slight curved, 1.0mm wide, 16cm</i>



LD-002-205 /  
LD-002-206



LD-001-193



LD-002-091 /  
LD-002-092



LD-001-195



LD-002-202 /  
LD-002-203



LD-001-196



LD-002-200 /  
LD-002-201

Bestell-Nr. Ordering no.	Bezeichnung Description
LD-001-091	PLESTER Raspatorium, 6mm breit, 18cm <i>PLESTER raspatory, 6mm wide, 18cm</i>
LD-001-092	PLESTER Raspatorium, 8mm breit, 18cm <i>PLESTER raspatory, 8mm wide, 18cm</i>
LD-001-193	EICKEN Raspatorium, Breite 6mm, 19.5cm <i>EICKEN raspatory, wide 6mm, 19.5cm</i>
LD-001-195	PLESTER Raspatorium, Breite 8mm, 18cm <i>PLESTER raspatory, wide 8mm, 18cm</i>
LD-001-196	FISCH Raspatorium, Breite 10mm, 15.5cm <i>FISCH raspatory, wide 10mm, 15.5cm</i>
LD-002-200	FARABOEUF Raspatorium, gerade, 13mm breit, 15cm <i>FARABOEUF raspatory, straight, 13mm wide, 15cm</i>
LD-002-201	FARABOEUF Raspatorium, gebogen, 13mm breit, 15cm <i>FARABOEUF raspatory, curved, 13mm wide, 15cm</i>
LD-002-202	FARABOEUF-COLLIN Raspatorium, gerade, 11mm breit, 17.5cm <i>FARABOEUF-COLLIN raspatory, straight, 11mm wide, 17.5cm</i>
LD-002-203	FARABOEUF-COLLIN Raspatorium, gebogen, 11mm breit, 17.5cm <i>FARABOEUF-COLLIN raspatory, curved, 11mm wide, 17.5cm</i>
LD-002-205	JANSEN Raspatorium, 9mm breit, 19.5cm <i>JANSEN raspatory, 9mm wide, 19.5cm</i>
LD-002-206	JANSEN Raspatorium, 14mm breit, 19.5cm <i>JANSEN raspatory, 14mm wide, 19.5cm</i>





LD-004-001



LD-002-207



LD-002-210  
bis / to  
LD-002-214



LD-002-215 /  
LD-002-216



LD-002-217 /  
LD-002-218



LD-004-003



LD-004-201 /  
LD-004-202

Bestell-Nr. Ordering no.	Bezeichnung Description
LD-002-207	JANSEN Raspatorium, 17cm <i>JANSEN raspatory, 17cm</i>
LD-002-210	LEMPERT Raspatorium, 2mm breit, 16cm <i>LEMPERT raspatory, 2mm wide, 16cm</i>
LD-002-211	LEMPERT Raspatorium, 3mm breit, 16cm <i>LEMPERT raspatory, 3mm wide, 16cm</i>
LD-002-212	LEMPERT Raspatorium, 3.5mm breit, 16cm <i>LEMPERT raspatory, 3.5mm wide, 16cm</i>
LD-002-213	LEMPERT Raspatorium, 4mm breit, 16cm <i>LEMPERT raspatory, 4mm wide, 16cm</i>
LD-002-214	LEMPERT Raspatorium, 5mm breit, 16cm <i>LEMPERT raspatory, 5mm wide, 16cm</i>
LD-002-215	WULLSTEIN Raspatorium, fein, 16cm <i>WULLSTEIN raspatory, delicate, 16cm</i>
LD-002-216	WULLSTEIN Raspatorium, breit, 16cm <i>WULLSTEIN raspatory, wide, 16cm</i>
LD-002-217	SHAMBOUGH-DERLACKI Raspatorium, 2.0mm, 16cm <i>SHAMBOUGH-DERLACKI raspatory, 2.0mm, 16cm</i>
LD-002-218	SHAMBOUGH-DERLACKI Raspatorium, 3.0mm, 16cm <i>SHAMBOUGH-DERLACKI raspatory, 3.0mm, 16cm</i>
LD-004-001	LEMPERT Raspatorium, 3mm, 19cm <i>LEMPERT raspatory, 3mm, 19cm</i>
LD-004-003	Raspatorium oval, 1.8mm, 16cm <i>Raspatory oval, 1.8mm, 16cm</i>
LD-004-201	Raspatorium, leicht gebogen, 1.0mm breit, 16cm <i>Raspatory, slightly curved, 1.0mm wide, 16cm</i>
LD-004-202	Raspatorium, leicht gebogen, 1.2mm breit, 16cm <i>Raspatory, slightly curved, 1.2mm wide, 16cm</i>



**LH-001-177**  
 bis / to  
**LH-001-180**



**LH-001-171**  
 bis / to  
**LH-001-173**



**LH-001-174**  
 bis / to  
**LH-001-176**

Bestell-Nr. Ordering no.	Bezeichnung Description
<b>LH-001-171</b>	BARON Spülkanüle, 45° gebogen, Ø 3 Ch., NL 75mm <i>BARON suction cannula, 45° curved, Ø 3 Fr., WL 75mm</i>
<b>LH-001-172</b>	BARON Spülkanüle, 45° gebogen, Ø 5 Ch., NL 75mm <i>BARON suction cannula, 45° curved, Ø 5 Fr., WL 75mm</i>
<b>LH-001-173</b>	BARON Spülkanüle, 45° gebogen, Ø 7 Ch., NL 75mm <i>BARON suction cannula, 45° curved, Ø 7 Fr., WL 75mm</i>
<b>LH-001-174</b>	SCHUHKNECHT Spülkanüle, 45° gebogen, Ø 20 GA, NL 75mm <i>SCHUHKNECHT suction cannula, 45° curved, Ø 20 GA, WL 75mm</i>
<b>LH-001-175</b>	SCHUHKNECHT Spülkanüle, 45° gebogen, Ø 22 GA, NL 75mm <i>SCHUHKNECHT suction cannula, 45° curved, Ø 22 GA, WL 75mm</i>
<b>LH-001-176</b>	SCHUHKNECHT Spülkanüle, 45° gebogen, Ø 24 GA, NL 75mm <i>SCHUHKNECHT suction cannula, 45° curved, Ø 24 GA, WL 75mm</i>
<b>LH-001-177</b>	Mc GEE Spülkanüle, 45° gebogen, Ø 20 GA, NL 80mm <i>Mc GEE suction cannula, 45° curved, Ø 20 GA, WL 80mm</i>
<b>LH-001-178</b>	Mc GEE Spülkanüle, 45° gebogen, Ø 22 GA, NL 80mm <i>Mc GEE suction cannula, 45° curved, Ø 22 GA, WL 80mm</i>
<b>LH-001-179</b>	Mc GEE Spülkanüle, 45° gebogen, Ø 24 GA, NL 80mm <i>Mc GEE suction cannula, 45° curved, Ø 24 GA, WL 80mm</i>
<b>LH-001-180</b>	Mc GEE Spülkanüle, 45° gebogen, Ø 26 GA, NL 80mm <i>Mc GEE suction cannula, 45° curved, Ø 26 GA, WL 80mm</i>



**LH-001-181**  
bis / to  
**LH-001-184**



**LH-001-185**  
bis / to  
**LH-001-188**



**LH-001-189**  
bis / to  
**LH-001-192**

Bestell-Nr. Ordering no.	Bezeichnung Description
<b>LH-001-181</b>	VERHOEVEN Spülkanüle, 45° gebogen, Öffnung gerade, Ø 1.2mm, NL 90mm VERHOEVEN suction cannula, 45° curved, opening straight, Ø 1.2mm, WL 90mm
<b>LH-001-182</b>	VERHOEVEN Spülkanüle, 45° gebogen, Öffnung gerade, Ø 1.5mm, NL 90mm VERHOEVEN suction cannula, 45° curved, opening straight, Ø 1.5mm, WL 90mm
<b>LH-001-183</b>	VERHOEVEN Spülkanüle, 45° gebogen, Öffnung gerade, Ø 2.0mm, NL 90mm VERHOEVEN suction cannula, 45° curved, opening straight, Ø 2.0mm, WL 90mm
<b>LH-001-184</b>	VERHOEVEN Spülkanüle, 45° gebogen, Öffnung gerade, Ø 3.0mm, NL 90mm VERHOEVEN suction cannula, 45° curved, opening straight, Ø 3.0mm, WL 90mm
<b>LH-001-185</b>	VERHOEVEN Spülkanüle, 45° gebogen, Öffnung nach unten, Ø 1.2mm, NL 90mm VERHOEVEN suction cannula, 45° curved, opening downward, Ø 1.2mm, WL 90mm
<b>LH-001-186</b>	VERHOEVEN Spülkanüle, 45° gebogen, Öffnung nach unten, Ø 1.5mm, NL 90mm VERHOEVEN suction cannula, 45° curved, opening downward, Ø 1.5mm, WL 90mm
<b>LH-001-187</b>	VERHOEVEN Spülkanüle, 45° gebogen, Öffnung nach unten, Ø 2.0mm, NL 90mm VERHOEVEN suction cannula, 45° curved, opening downward, Ø 2.0mm, WL 90mm
<b>LH-001-188</b>	VERHOEVEN Spülkanüle, 45° gebogen, Öffnung nach unten, Ø 3.0mm, NL 90mm VERHOEVEN suction cannula, 45° curved, opening downward, Ø 3.0mm, WL 90mm
<b>LH-001-189</b>	VERHOEVEN Spülkanüle, 45° gebogen, Öffnung nach oben, Ø 1.2mm, NL 90mm VERHOEVEN suction cannula, 45° curved, opening upward, Ø 1.2mm, WL 90mm
<b>LH-001-190</b>	VERHOEVEN Spülkanüle, 45° gebogen, Öffnung nach oben, Ø 1.5mm, NL 90mm VERHOEVEN suction cannula, 45° curved, opening upward, Ø 1.5mm, WL 90mm
<b>LH-001-191</b>	VERHOEVEN Spülkanüle, 45° gebogen, Öffnung nach oben, Ø 2.0mm, NL 90mm VERHOEVEN suction cannula, 45° curved, opening upward, Ø 2.0mm, WL 90mm
<b>LH-001-192</b>	VERHOEVEN Spülkanüle, 45° gebogen, Öffnung nach oben, Ø 3.0mm, NL 90mm VERHOEVEN suction cannula, 45° curved, opening upward, Ø 3.0mm, WL 90mm



**LH-001-200**  
 bis / to  
**LH-001-208**



**LH-001-230**  
 bis / to  
**LH-001-235**

Bestell-Nr. Ordering no.	Bezeichnung Description
<b>LH-001-200</b>	ROSEN Spülkanüle mit LL, 45° gebogen, Ø 0.6mm, NL 65mm ROSEN suction cannula with LL, 45° curved, Ø 0.6mm, WL 65mm
<b>LH-001-201</b>	ROSEN Spülkanüle mit LL, 45° gebogen, Ø 0.7mm, NL 65mm ROSEN suction cannula with LL, 45° curved, Ø 0.7mm, WL 65mm
<b>LH-001-202</b>	ROSEN Spülkanüle mit LL, 45° gebogen, Ø 0.8mm, NL 65mm ROSEN suction cannula with LL, 45° curved, Ø 0.8mm, WL 65mm
<b>LH-001-203</b>	ROSEN Spülkanüle mit LL, 45° gebogen, Ø 0.9mm, NL 65mm ROSEN suction cannula with LL, 45° curved, Ø 0.9mm, WL 65mm
<b>LH-001-204</b>	ROSEN Spülkanüle mit LL, 45° gebogen, Ø 1.0mm, NL 65mm ROSEN suction cannula with LL, 45° curved, Ø 1.0mm, WL 65mm
<b>LH-001-205</b>	ROSEN Spülkanüle mit LL, 45° gebogen, Ø 1.2mm, NL 65mm ROSEN suction cannula with LL, 45° curved, Ø 1.2mm, WL 65mm
<b>LH-001-206</b>	ROSEN Spülkanüle mit LL, 45° gebogen, Ø 1.5mm, NL 65mm ROSEN suction cannula with LL, 45° curved, Ø 1.5mm, WL 65mm
<b>LH-001-207</b>	ROSEN Spülkanüle mit LL, 45° gebogen, Ø 1.6mm, NL 65mm ROSEN suction cannula with LL, 45° curved, Ø 1.6mm, WL 65mm
<b>LH-001-208</b>	ROSEN Spülkanüle mit LL, 45° gebogen, Ø 1.8mm, NL 65mm ROSEN suction cannula with LL, 45° curved, Ø 1.8mm, WL 65mm
<b>LH-001-230</b>	NIJMEGEN Absaugrohr, Ø 1.0mm, 60mm Arbeitslänge NIJMEGEN suction tube, Ø 1.0mm, 60mm working length
<b>LH-001-231</b>	NIJMEGEN Absaugrohr, Ø 1.5mm, 60mm Arbeitslänge NIJMEGEN suction tube, Ø 1.5mm, 60mm working length
<b>LH-001-232</b>	NIJMEGEN Absaugrohr, Ø 2.0mm, 60mm Arbeitslänge NIJMEGEN suction tube, Ø 2.0mm, 60mm working length
<b>LH-001-233</b>	NIJMEGEN Absaugrohr, Ø 2.5mm, 60mm Arbeitslänge NIJMEGEN suction tube, Ø 2.5mm, 60mm working length
<b>LH-001-234</b>	NIJMEGEN Absaugrohr, Ø 3.0mm, 60mm Arbeitslänge NIJMEGEN suction tube, Ø 3.0mm, 60mm working length
<b>LH-001-235</b>	NIJMEGEN Absaugrohr, Ø 4.0mm, 60mm Arbeitslänge NIJMEGEN suction tube, Ø 4.0mm, 60mm working length



**LH-001-210**  
bis / to  
**LH-001-227**

Bestell-Nr. Ordering no.	Bezeichnung Description
<b>LH-001-210</b>	HOUSE Saug-Spülkanüle, 2.5/2.0 Ch., 45° gebogen, NL 70mm HOUSE suction-irrigation cannula, 2.5/2.0 Fr., 45° curved, WL 70mm
<b>LH-001-211</b>	HOUSE Saug-Spülkanüle, 4.0/2.0 Ch., 45° gebogen, NL 70mm HOUSE suction-irrigation cannula, 4.0/2.0 Fr., 45° curved, WL 70mm
<b>LH-001-212</b>	HOUSE Saug-Spülkanüle, 5.0/4.0 Ch., 45° gebogen, NL 70mm HOUSE suction-irrigation cannula, 5.0/4.0 Fr., 45° curved, WL 70mm
<b>LH-001-213</b>	HOUSE Saug-Spülkanüle, 7.0/5.0 Ch., 45° gebogen, NL 70mm HOUSE suction-irrigation cannula, 7.0/5.0 Fr., 45° curved, WL 70mm
<b>LH-001-214</b>	HOUSE Saug-Spülkanüle, 8.0/6.0 Ch., 45° gebogen, NL 70mm HOUSE suction-irrigation cannula, 8.0/6.0 Fr., 45° curved, WL 70mm
<b>LH-001-215</b>	HOUSE Saug-Spülkanüle, 10.0/7.0 Ch., 45° gebogen, NL 70mm HOUSE suction-irrigation cannula, 10.0/7.0 Fr., 45° curved, WL 70mm
<b>LH-001-216</b>	HOUSE Saug-Spülkanüle, 12.0/8.0 Ch., 45° gebogen, NL 70mm HOUSE suction-irrigation cannula, 12.0/8.0 Fr., 45° curved, WL 70mm
<b>LH-001-217</b>	HOUSE Saug-Spülkanüle, 14.0/12.0 Ch., 45° gebogen, NL 70mm HOUSE suction-irrigation cannula, 14.0/12.0 Fr., 45° curved, WL 70mm
<b>LH-001-220</b>	HOUSE Saug-Spülkanüle, 2.5/2.0 Ch., 45° gebogen, NL 90mm HOUSE suction-irrigation cannula, 2.5/2.0 Fr., 45° curved, WL 90mm
<b>LH-001-221</b>	HOUSE Saug-Spülkanüle, 4.0/2.0 Ch., 45° gebogen, NL 90mm HOUSE suction-irrigation cannula, 4.0/2.0 Fr., 45° curved, WL 90mm
<b>LH-001-222</b>	HOUSE Saug-Spülkanüle, 5.0/4.0 Ch., 45° gebogen, NL 90mm HOUSE suction-irrigation cannula, 5.0/4.0 Fr., 45° curved, WL 90mm
<b>LH-001-223</b>	HOUSE Saug-Spülkanüle, 7.0/5.0 Ch., 45° gebogen, NL 90mm HOUSE suction-irrigation cannula, 7.0/5.0 Fr., 45° curved, WL 90mm
<b>LH-001-224</b>	HOUSE Saug-Spülkanüle, 8.0/6.0 Ch., 45° gebogen, NL 90mm HOUSE suction-irrigation cannula, 8.0/6.0 Fr., 45° curved, WL 90mm
<b>LH-001-225</b>	HOUSE Saug-Spülkanüle, 10.0/7.0 Ch., 45° gebogen, NL 90mm HOUSE suction-irrigation cannula, 10.0/7.0 Fr., 45° curved, WL 90mm
<b>LH-001-226</b>	HOUSE Saug-Spülkanüle, 12.0/8.0 Ch., 45° gebogen, NL 90mm HOUSE suction-irrigation cannula, 12.0/8.0 Fr., 45° curved, WL 90mm
<b>LH-001-227</b>	HOUSE Saug-Spülkanüle, 14.0/12.0 Ch., 45° gebogen, NL 90mm HOUSE suction-irrigation cannula, 14.0/12.0 Fr., 45° curved, WL 90mm

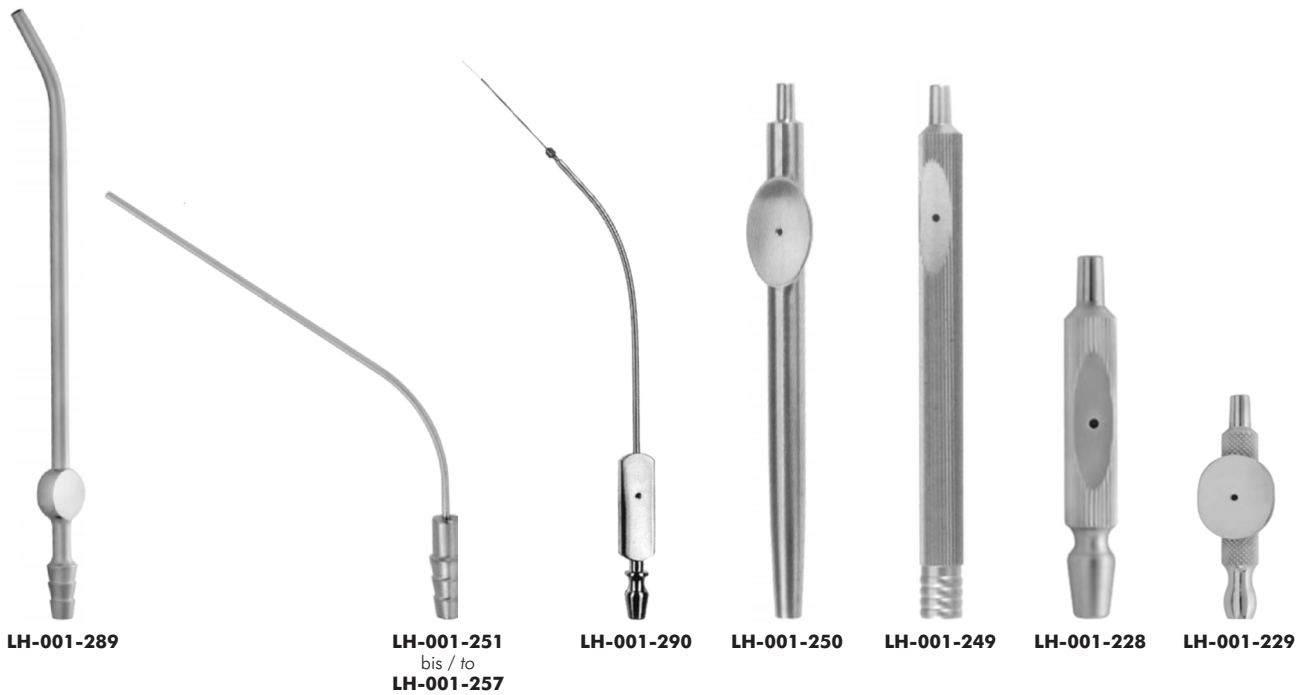

Bestell-Nr. Ordering no.	Bezeichnung Description
LH-001-228	WULLSTEIN Saugadaptor, 11cm, Luer Konus WULLSTEIN suction adaptor, 11cm, luer cone
LH-001-229	HOUSE Saugadaptor, 5cm, Luer Konus HOUSE suction adaptor, 5cm, luer cone
LH-001-249	Saughandgriff mit Luer Konus und Unterbrecher, für Spülkanülen LH-001-200 bis LH-001-208 Suction handle with Luer cone and cut-off hole, for suction cannulas LH-001-200 to LH-001-208
LH-001-250	Saughandgriff mit Luer Konus und Unterbrecher, für Spülkanülen LH-001-200 bis LH-001-208 Suction handle with Luer cone and cut-off hole, for suction cannulas LH-001-200 to LH-001-208
LH-001-251	Saugrohr mit LL, 60° gebogen, zylindrisch, Ø 1.0mm, Arbeitslänge 90mm Suction tube with LL, 60° angled, cylindric, Ø 1.0mm, working length 90mm
LH-001-252	Saugrohr mit LL, 60° gebogen, zylindrisch, Ø 1.5mm, Arbeitslänge 90mm Suction tube with LL, 60° angled, cylindric, Ø 1.5mm, working length 90mm
LH-001-253	Saugrohr mit LL, 60° gebogen, zylindrisch, Ø 2.0mm, Arbeitslänge 90mm Suction tube with LL, 60° angled, cylindric, Ø 2.0mm, working length 90mm
LH-001-254	Saugrohr mit LL, 60° gebogen, zylindrisch, Ø 2.5mm, Arbeitslänge 90mm Suction tube with LL, 60° angled, cylindric, Ø 2.5mm, working length 90mm
LH-001-255	Saugrohr mit LL, 60° gebogen, zylindrisch, Ø 3.0mm, Arbeitslänge 90mm Suction tube with LL, 60° angled, cylindric, Ø 3.0mm, working length 90mm
LH-001-256	Saugrohr mit LL, 60° gebogen, zylindrisch, Ø 4.0mm, Arbeitslänge 90mm Suction tube with LL, 60° angled, cylindric, Ø 4.0mm, working length 90mm
LH-001-257	Saugrohr mit LL, 60° gebogen, zylindrisch, Ø 5.0mm, Arbeitslänge 90mm Suction tube with LL, 60° angled, cylindric, Ø 5.0mm, working length 90mm
LH-001-280	BARNES Saugrohr mit LL, Ø 1.5mm, AL 50mm BARNES suction tube with LL, Ø 1.5mm, WL 50mm
LH-001-281	BARNES Saugrohr mit LL, 60° gebogen, zylindrisch, Ø 1.5mm, Arbeitslänge 90mm BARNES suction tube with LL, 60° angled, cylindric, Ø 1.5mm, working length 90mm
LH-001-282	BARNES Saugrohr mit LL, 60° gebogen, zylindrisch, Ø 2.0mm, Arbeitslänge 90mm BARNES suction tube with LL, 60° angled, cylindric, Ø 2.0mm, working length 90mm
LH-001-289	Saugrohr gebogen, konisch, LL, Ø 4.5mm, AL 155mm Suction tube curved, conical, LL, Ø 4.5mm, WL 155mm
LH-001-290	ZÖLLNER Saugrohr mit Aufsatz, LL, 15cm ZÖLLNER suction tube with attachment, LL, 15cm



**LD-002-044**  
bis / to  
**LD-002-047**



**LD-002-373 /**  
**LD-002-374**



**LD-002-025**  
bis / to  
**LD-002-029**



**LD-002-049 /**  
**LD-002-050**

<b>Bestell-Nr.</b> <b>Ordering no.</b>	<b>Bezeichnung</b> <b>Description</b>
<b>LD-002-025</b>	TRAUTMANN Flachmeißel, 2.0mm, 14cm TRAUTMANN flat chisel, 2.0mm, 14cm
<b>LD-002-026</b>	TRAUTMANN Flachmeißel, 3.0mm, 14cm TRAUTMANN flat chisel, 3.0mm, 14cm
<b>LD-002-027</b>	TRAUTMANN Flachmeißel, 5.0mm, 14cm TRAUTMANN flat chisel, 5.0mm, 14cm
<b>LD-002-028</b>	TRAUTMANN Flachmeißel, 7.0mm, 14cm TRAUTMANN hollow chisel, 7.0mm, 14cm
<b>LD-002-029</b>	TRAUTMANN Flachmeißel, 9.0mm, 14cm TRAUTMANN flat chisel, 9.0mm, 14cm
<b>LD-002-044</b>	BRÜNING'S Flachmeißel, 4.0mm, 16cm BRÜNING'S flat chisel, 4.0mm, 16cm
<b>LD-002-045</b>	BRÜNING'S Flachmeißel, 6.0mm, 16cm BRÜNING'S flat chisel, 6.0mm, 16cm
<b>LD-002-046</b>	BRÜNING'S Flachmeißel, 8.0mm, 16cm BRÜNING'S flat chisel, 8.0mm, 16cm
<b>LD-002-047</b>	BRÜNING'S Flachmeißel, 10.0mm, 16cm BRÜNING'S flat chisel, 10.0mm, 16cm
<b>LD-002-049</b>	PASSOW Blutstillungsmeißel, 2mm quadratisch, 12cm PASSOW haemostatic chisel, 2mm square shaped, 12cm
<b>LD-002-050</b>	PASSOW Blutstillungsmeißel, 3mm quadratisch, 12cm PASSOW haemostatic chisel, 3mm square shaped, 12cm
<b>LD-002-373</b>	THIES Flachmeißel, 3mm, 16cm THIES flat chisel, 3mm, 16cm
<b>LD-002-374</b>	THIES Flachmeißel, 4mm, 16cm THIES flat chisel, 4mm, 16cm





**LD-002-040**  
bis / to  
**LD-002-043**



**LD-002-020**  
bis / to  
**LD-002-023**

<b>Bestell-Nr. Ordering no.</b>	<b>Bezeichnung Description</b>
<b>LD-002-020</b>	TRAUTMANN Hohlmeißel, 3.0mm, 14cm <i>TRAUTMANN gouge, 3.0mm, 14cm</i>
<b>LD-002-021</b>	TRAUTMANN Hohlmeißel, 5.0mm, 14cm <i>TRAUTMANN gouge, 5.0mm, 14cm</i>
<b>LD-002-022</b>	TRAUTMANN Hohlmeißel, 7.0mm, 14cm <i>TRAUTMANN gouge, 7.0mm, 14cm</i>
<b>LD-002-023</b>	TRAUTMANN Hohlmeißel, 9.0mm, 14cm <i>TRAUTMANN gouge, 9.0mm, 14cm</i>
<b>LD-002-040</b>	BRÜNING'S Hohlmeißel, 4.0mm, 16cm <i>BRÜNING'S gouge, 4.0mm, 16cm</i>
<b>LD-002-041</b>	BRÜNING'S Hohlmeißel, 6.0mm, 16cm <i>BRÜNING'S gouge, 6.0mm, 16cm</i>
<b>LD-002-042</b>	BRÜNING'S Hohlmeißel, 8.0mm, 16cm <i>BRÜNING'S gouge, 8.0mm, 16cm</i>
<b>LD-002-043</b>	BRÜNING'S Hohlmeißel, 10.0mm, 16cm <i>BRÜNING'S gouge, 10.0mm, 16cm</i>
<b>LD-002-375</b>	THIES Hohlmeißel, 3mm, 16cm (ohne Abbildung) <i>THIES gouge, 3mm, 16cm (without illustration)</i>
<b>LD-002-376</b>	THIES Hohlmeißel, 4mm, 16cm (ohne Abbildung) <i>THIES gouge, 4mm, 16cm (without illustration)</i>



LD-002-104



LD-002-102



LD-002-101

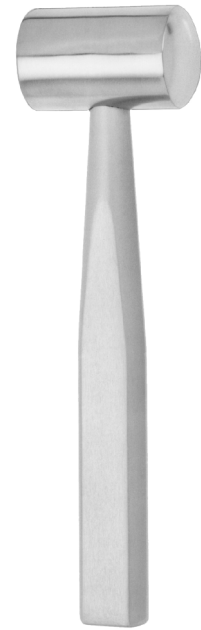

LD-002-100

Bestell-Nr. Ordering no.	Bezeichnung Description
LD-002-100	COTTLE Metallhammer, 18cm COTTLE metal hammer, 18cm
LD-002-101	Metallhammer mit Bleifüllung, 20cm Metal hammer, lead filled, 20cm
LD-002-102	COTTLE Metallhammer mit auswechselbaren Kunststoff-Schlagflächen, 22.5 cm COTTLE metal hammer, interchangeable plastic discs, 22.5cm
LD-002-103	Kunststoff-Schlagflächen für LD-002-102, paarweise (ohne Abbildung) Interchangeable plastic discs for LD-002-102, pair (without illustration)
LD-002-104	HAEK Metallhammer, massiv, 27cm HAEK metal hammer, solid, 27cm



**ZA-001-488 /  
ZA-001-488-1**



**ZA-001-487 /  
ZA-001-487-1**



**ZA-001-486 /  
ZA-001-486-1**



**LC-030-001-1/  
LC-030-002-1**

<b>Bestell-Nr. Ordering no.</b>	<b>Bezeichnung Description</b>
<b>LC-030-001-1</b>	HARTMANN Ohrtamponzängchen, extra fein, NL 6cm HARTMANN ear tampon forceps, extra delicate, WL 6cm
<b>LC-030-001-2</b>	HARTMANN Ohrtamponzängchen, fein, NL 6cm HARTMANN ear tampon forceps, delicate, WL 6cm
<b>ZA-001-486</b>	TROELTSCH Ohr-/Nasenpinzette, anatomisch, fein, 11cm TROELTSCH ear/nose dressing forceps, delicate, 11cm
<b>ZA-001-486-1</b>	TROELTSCH Ohrpinzette, anatomisch, fein, 13cm TROELTSCH ear dressing forceps, delicate, 13cm
<b>ZA-001-487</b>	LUCAE Ohr-/Nasenpinzette, anatomisch, bajonettförmig, 14cm LUCAE ear/nose dressing forceps, bayonet shape, 14cm
<b>ZA-001-487-1</b>	LUCAE Ohrpinzette, anatomisch, bajonettförmig, fein, 14cm LUCAE ear dressing forceps, bayonet shape, delicate, 14cm
<b>ZA-001-488</b>	JANSEN Ohrpinzette, anatomisch, bajonettförmig, 16cm JANSEN ear dressing forceps, bayonet shape, 16cm
<b>ZA-001-488-1</b>	JANSEN Ohrpinzette, anatomisch, bajonettförmig, fein, 16cm JANSEN ear dressing forceps, bayonet shape, delicate, 16cm



**LC-020-020 /  
 LC-020-024**  
 bis / to  
**LC-020-027 /  
 LC-060-202**

**LC-020-020 /  
 LC-020-024**  
 bis / to  
**LC-020-027 /  
 LC-060-202**



**LC-020-021 /  
 LC-020-028 /  
 LC-020-029 /  
 LC-060-200**

**LC-020-021 /  
 LC-020-028 /  
 LC-020-029 /  
 LC-060-200**

<b>Bestell-Nr. Ordering no.</b>	<b>Bezeichnung Description</b>
<b>LC-020-020</b>	GREVEN Drahtschliesszange, gerade, NL 8cm GREVEN wire close forceps, straight, WL 8cm
<b>LC-020-021</b>	HOUSE-DIETER Hammerkopfstanze, nach oben schneidend, NL 8cm HOUSE-DIETER hammer head punch, upward cutting, WL 8cm
<b>LC-020-024</b>	MCGEE Drahtschliesszange, gerade, NL 8cm MCGEE wire close forceps, straight, WL 8cm
<b>LC-020-025</b>	FISCH-MCGEE Drahtschliesszange, gerade, NL 8cm FISCH-MCGEE wire close forceps, straight, WL 8cm
<b>LC-020-026</b>	FISCH-MCGEE Drahtschliesszange, rechts gebogen, NL 8cm FISCH-MCGEE wire close forceps, curved right, WL 8cm
<b>LC-020-027</b>	FISCH-MCGEE Drahtschliesszange, links gebogen, NL 8cm FISCH-MCGEE wire close forceps, curved left, WL 8cm
<b>LC-020-028</b>	HOUSE-DIETER Hammerkopfstanze, nach unten schneidend, NL 8cm HOUSE-DIETER hammer head punch, downward cutting, WL 8cm
<b>LC-020-029</b>	FISCH-DIETER Hammerkopfstanze, nach oben schneidend, extra zart, 0.8mm, NL 8cm FISCH-DIETER hammer head punch, upward cutting, extra delicate, 0.8mm, WL 8cm
<b>LC-060-200</b>	DIETER Hammerkopfstanze, nach oben schneidend, NL 8cm DIETER hammer head punch, upward cutting, WL 8cm
<b>LC-060-202</b>	MCGEE Drahtschliesszange, 1.8 x 0.8 x 5mm, NL 8cm FISCH-MCGEE wire close forceps, 1.8 x 0.8 x 5mm, WL 8cm

**LC-020-022 /**  
**LC-020-023**

**LC-060-001**

**LC-040-001**

**LC-060-020**

**LC-040-002**

**LC-060-021**  
 bis / to  
**LC-060-036**

**LC-020-022**  
 bis / to  
**LC-060-036**

<b>Bestell-Nr.</b> <b>Ordering no.</b>	<b>Bezeichnung</b> <b>Description</b>
<b>LC-020-022</b>	WULLSTEIN Ohrzange, extra zart, ovaler Löffel, Ø 0.6mm, NL 8cm WULLSTEIN ear forceps, extra fine, oval spoon, Ø 0.6mm, WL 8cm
<b>LC-020-023</b>	WULLSTEIN Ohrzange, extra zart, ovaler Löffel, Ø 0.9mm, NL 8cm WULLSTEIN ear forceps, extra fine, oval spoon, Ø 0.9mm, WL 8cm
<b>LC-040-001</b>	Löffelzängchen, extra zart, oval, Ø 0.6mm, gerade, NL 15cm Spoon forceps, extra fine, oval, Ø 0.6mm, straight, WL 15cm
<b>LC-040-002</b>	Löffelzängchen, extra zart, oval, Ø 0.6mm, 45° auwärts gebogen, NL 15cm Spoon forceps, extra fine, oval, Ø 0.6mm, 45° upward curved, WL 15cm
<b>LC-060-001</b>	Mikro-Ohrenzange, 1.8 x 0.6mm, NL 8cm Micro cup forceps, 1.8 x 0.6mm, WL 8cm
<b>LC-060-020</b>	HARTMANN Ohrenzange, durchschneidend, gerade, NL 8cm HARTMANN ear forceps, cutting through, straight, WL 8cm
<b>LC-060-021</b>	HARTMANN Ohrenzange, zart, 1.8 x 0.8 x 4mm, NL 8cm HARTMANN ear forceps, delicate, 1.8 x 0.8 x 4mm, WL 8cm
<b>LC-060-022</b>	HARTMANN Ohrenzange, zart, 1.8 x 0.8 x 4mm, NL 12.5cm HARTMANN ear forceps, delicate, 1.8 x 0.8 x 4mm, WL 12.5cm
<b>LC-060-023</b>	HARTMANN Ohrenzange, zart, 1.8 x 0.8 x 4mm, NL 15cm HARTMANN ear forceps, delicate, 1.8 x 0.8 x 4mm, WL 15cm
<b>LC-060-024</b>	HARTMANN Ohrenzange, zart, 1.8 x 0.8 x 4mm, NL 18cm HARTMANN ear forceps, delicate, 1.8 x 0.8 x 4mm, WL 18cm
<b>LC-060-025</b>	HARTMANN Ohrenzange, gerade glatt, 1.8 x 0.8 x 4mm, NL 8cm HARTMANN ear forceps, straight smooth, 1.8 x 0.8 x 4mm, WL 8cm
<b>LC-060-026</b>	HARTMANN Ohrenzange, gerade glatt, 1.8 x 0.8 x 4mm, NL 12.5cm HARTMANN ear forceps, straight smooth, 1.8 x 0.8 x 4mm, WL 12.5cm
<b>LC-060-027</b>	HARTMANN Ohrenzange, gerade glatt, 1.8 x 0.8 x 4mm, NL 15cm HARTMANN ear forceps, straight smooth, 1.8 x 0.8 x 4mm, WL 15cm
<b>LC-060-028</b>	HARTMANN Ohrenzange, gerade glatt, 1.8 x 0.8 x 4mm, NL 18cm HARTMANN ear forceps, straight smooth, 1.8 x 0.8 x 4mm, WL 18cm
<b>LC-060-029</b>	HARTMANN Ohrenzange, rechts gebogen, 1.8 x 0.8 x 4mm, NL 8cm HARTMANN ear forceps, curved right, 1.8 x 0.8 x 4mm, WL 8cm
<b>LC-060-030</b>	HARTMANN Ohrenzange, rechts gebogen, 1.8 x 0.8 x 4mm, NL 12.5cm HARTMANN ear forceps, curved right, 1.8 x 0.8 x 4mm, WL 12.5cm
<b>LC-060-031</b>	HARTMANN Ohrenzange, rechts gebogen, 1.8 x 0.8 x 4mm, NL 15cm HARTMANN ear forceps, curved right, 1.8 x 0.8 x 4mm, WL 15cm
<b>LC-060-032</b>	HARTMANN Ohrenzange, rechts gebogen, 1.8 x 0.8 x 4mm, NL 18cm HARTMANN ear forceps, curved right, 1.8 x 0.8 x 4mm, WL 18cm
<b>LC-060-033</b>	HARTMANN Ohrenzange, links gebogen, 1.8 x 0.8 x 4mm, NL 8cm HARTMANN ear forceps, curved left, 1.8 x 0.8 x 4mm, WL 8cm
<b>LC-060-034</b>	HARTMANN Ohrenzange, links gebogen, 1.8 x 0.8 x 4mm, NL 12.5cm HARTMANN ear forceps, curved left, 1.8 x 0.8 x 4mm, WL 12.5cm
<b>LC-060-035</b>	HARTMANN Ohrenzange, links gebogen, 1.8 x 0.8 x 4mm, NL 15cm HARTMANN ear forceps, curved left, 1.8 x 0.8 x 4mm, WL 15cm
<b>LC-060-036</b>	HARTMANN Ohrenzange, links gebogen, 1.8 x 0.8 x 4mm, NL 18cm HARTMANN ear forceps, curved left, 1.8 x 0.8 x 4mm, WL 18cm



**LC-060-037** bis / to **LC-060-044**  
**LC-060-049** bis / to **LC-060-052**



**LC-060-045**  
bis / to  
**LC-060-048**



**LC-060-053**  
bis / to  
**LC-060-056**



**LC-060-037**  
bis / to  
**LC-060-052**

Bestell-Nr. Ordering no.	Bezeichnung Description
<b>LC-060-037</b>	HARTMANN Ohrenzange, aufwärts gebogen, 1.8 x 0.8 x 4mm, NL 8cm HARTMANN ear forceps, upward curved, 1.8 x 0.8 x 4mm, WL 8cm
<b>LC-060-038</b>	HARTMANN Ohrenzange, aufwärts gebogen, 1.8 x 0.8 x 4mm, NL 12.5cm HARTMANN ear forceps, upward curved, 1.8 x 0.8 x 4mm, WL 12.5cm
<b>LC-060-039</b>	HARTMANN Ohrenzange, aufwärts gebogen, 1.8 x 0.8 x 4mm, NL 15cm HARTMANN ear forceps, upward curved, 1.8 x 0.8 x 4mm, WL 15cm
<b>LC-060-040</b>	HARTMANN Ohrenzange, aufwärts gebogen, 1.8 x 0.8 x 4mm, NL 18cm HARTMANN ear forceps, upward curved, 1.8 x 0.8 x 4mm, WL 18cm
<b>LC-060-041</b>	HARTMANN Ohrenzange, abwärts gebogen, 1.8 x 0.8 x 4mm, NL 8cm HARTMANN ear forceps, downward curved, 1.8 x 0.8 x 4mm, WL 8cm
<b>LC-060-042</b>	HARTMANN Ohrenzange, abwärts gebogen, 1.8 x 0.8 x 4mm, NL 12.5cm HARTMANN ear forceps, downward curved, 1.8 x 0.8 x 4mm, WL 12.5cm
<b>LC-060-043</b>	HARTMANN Ohrenzange, abwärts gebogen, 1.8 x 0.8 x 4mm, NL 15cm HARTMANN ear forceps, downward curved, 1.8 x 0.8 x 4mm, WL 15cm
<b>LC-060-044</b>	HARTMANN Ohrenzange, abwärts gebogen, 1.8 x 0.8 x 4mm, NL 18cm HARTMANN ear forceps, downward curved, 1.8 x 0.8 x 4mm, WL 18cm
<b>LC-060-045</b>	FISCH Ohrenzange, extra zart, 1.3 x 0.7 x 3.5mm, NL 8cm FISCH ear forceps, very delicate, 1.3 x 0.7 x 3.5mm, WL 8cm
<b>LC-060-046</b>	FISCH Ohrenzange, extra zart, 1.3 x 0.7 x 3.5mm, NL 12.5cm FISCH ear forceps, very delicate, 1.3 x 0.7 x 3.5mm, WL 12.5cm
<b>LC-060-047</b>	FISCH Ohrenzange, extra zart, 1.3 x 0.7 x 3.5mm, NL 15cm FISCH ear forceps, very delicate, 1.3 x 0.7 x 3.5mm, WL 15cm
<b>LC-060-048</b>	FISCH Ohrenzange, extra zart, 1.3 x 0.7 x 3.5mm, NL 18cm FISCH ear forceps, very delicate, 1.3 x 0.7 x 3.5mm, WL 18cm
<b>LC-060-049</b>	HARTMANN Ohrenzange, zart, 1.8 x 0.8 x 6mm, NL 8cm HARTMANN ear forceps, delicate, 1.8 x 0.8 x 6mm, WL 8cm
<b>LC-060-050</b>	HARTMANN Ohrenzange, zart, 1.8 x 0.8 x 6mm, NL 12.5cm HARTMANN ear forceps, delicate, 1.8 x 0.8 x 6mm, WL 12.5cm
<b>LC-060-051</b>	HARTMANN Ohrenzange, zart, 1.8 x 0.8 x 6mm, NL 15cm HARTMANN ear forceps, delicate, 1.8 x 0.8 x 6mm, WL 15cm
<b>LC-060-052</b>	HARTMANN Ohrenzange, zart, 1.8 x 0.8 x 6mm, NL 18cm HARTMANN ear forceps, delicate, 1.8 x 0.8 x 6mm, WL 18cm
<b>LC-060-053</b>	HARTMANN Ohrenzange, gerade glatt, 1.8 x 0.8 x 6mm, NL 8cm HARTMANN ear forceps, straight smooth, 1.8 x 0.8 x 6mm, WL 8cm
<b>LC-060-054</b>	HARTMANN Ohrenzange, gerade glatt, 1.8 x 0.8 x 6mm, NL 12.5cm HARTMANN ear forceps, straight smooth, 1.8 x 0.8 x 6mm, WL 12.5cm
<b>LC-060-055</b>	HARTMANN Ohrenzange, gerade glatt, 1.8 x 0.8 x 6mm, NL 15cm HARTMANN ear forceps, straight smooth, 1.8 x 0.8 x 6mm, WL 15cm
<b>LC-060-056</b>	HARTMANN Ohrenzange, gerade glatt, 1.8 x 0.8 x 6mm, NL 18cm HARTMANN ear forceps, straight smooth, 1.8 x 0.8 x 6mm, WL 18cm



**LC-060-057**  
bis / to  
**LC-060-074**



**LC-060-105**  
bis / to  
**LC-060-108**



**LC-060-057**  
bis / to  
**LC-060-108**

<b>Bestell-Nr.</b> <b>Ordering no.</b>	<b>Bezeichnung</b> <b>Description</b>
<b>LC-060-057</b>	HARTMANN Ohrenzange, rechts gebogen, 1.8 x 0.8 x 6mm, NL 8cm <i>HARTMANN ear forceps, curved right, 1.8 x 0.8 x 6mm, WL 8cm</i>
<b>LC-060-058</b>	HARTMANN Ohrenzange, rechts gebogen, 1.8 x 0.8 x 6mm, NL 12.5cm <i>HARTMANN ear forceps, curved right, 1.8 x 0.8 x 6mm, WL 12.5cm</i>
<b>LC-060-059</b>	HARTMANN Ohrenzange, rechts gebogen, 1.8 x 0.8 x 6mm, NL 15cm <i>HARTMANN ear forceps, curved right, 1.8 x 0.8 x 6mm, WL 15cm</i>
<b>LC-060-060</b>	HARTMANN Ohrenzange, rechts gebogen, 1.8 x 0.8 x 6mm, NL 18cm <i>HARTMANN ear forceps, curved right, 1.8 x 0.8 x 6mm, WL 18cm</i>
<b>LC-060-061</b>	HARTMANN Ohrenzange, links gebogen, 1.8 x 0.8 x 6mm, NL 8cm <i>HARTMANN ear forceps, curved left, 1.8 x 0.8 x 6mm, WL 8cm</i>
<b>LC-060-062</b>	HARTMANN Ohrenzange, links gebogen, 1.8 x 0.8 x 6mm, NL 12.5cm <i>HARTMANN ear forceps, curved left, 1.8 x 0.8 x 6mm, WL 12.5cm</i>
<b>LC-060-063</b>	HARTMANN Ohrenzange, links gebogen, 1.8 x 0.8 x 6mm, NL 15cm <i>HARTMANN ear forceps, curved left, 1.8 x 0.8 x 6mm, WL 15cm</i>
<b>LC-060-064</b>	HARTMANN Ohrenzange, links gebogen, 1.8 x 0.8 x 6mm, NL 18cm <i>HARTMANN ear forceps, curved left, 1.8 x 0.8 x 6mm, WL 18cm</i>
<b>LC-060-065</b>	HARTMANN Ohrenzange, aufwärts gebogen, 1.8 x 0.8 x 6mm, NL 8cm <i>HARTMANN ear forceps, upward curved, 1.8 x 0.8 x 6mm, WL 8cm</i>
<b>LC-060-066</b>	HARTMANN Ohrenzange, aufwärts gebogen, 1.8 x 0.8 x 6mm, NL 12.5cm <i>HARTMANN ear forceps, upward curved, 1.8 x 0.8 x 6mm, WL 12.5cm</i>
<b>LC-060-067</b>	HARTMANN Ohrenzange, aufwärts gebogen, 1.8 x 0.8 x 6mm, NL 15cm <i>HARTMANN ear forceps, upward curved, 1.8 x 0.8 x 6mm, WL 15cm</i>
<b>LC-060-068</b>	HARTMANN Ohrenzange, aufwärts gebogen, 1.8 x 0.8 x 6mm, NL 18cm <i>HARTMANN ear forceps, upward curved, 1.8 x 0.8 x 6mm, WL 18cm</i>
<b>LC-060-069</b>	HARTMANN Ohrenzange, abwärts gebogen, 1.8 x 0.8 x 6mm, NL 8cm <i>HARTMANN ear forceps, downward curved, 1.8 x 0.8 x 6mm, WL 8cm</i>
<b>LC-060-070</b>	HARTMANN Ohrenzange, abwärts gebogen, 1.8 x 0.8 x 6mm, NL 12.5cm <i>HARTMANN ear forceps, downward curved, 1.8 x 0.8 x 6mm, WL 12.5cm</i>
<b>LC-060-071</b>	HARTMANN Ohrenzange, abwärts gebogen, 1.8 x 0.8 x 6mm, NL 15cm <i>HARTMANN ear forceps, downward curved, 1.8 x 0.8 x 6mm, WL 15cm</i>
<b>LC-060-074</b>	HARTMANN Ohrenzange, abwärts gebogen, 1.8 x 0.8 x 6mm, NL 18cm <i>HARTMANN ear forceps, downward curved, 1.8 x 0.8 x 6mm, WL 18cm</i>
<b>LC-060-105</b>	DUCKBILL Ohrenzange, flaches Maul, 1.2 x 2.5 x 8.0mm, NL 8cm <i>DUCKBILL ear forceps, flat jaw, 1.2 x 2.5 x 8.0mm, WL 8cm</i>
<b>LC-060-106</b>	DUCKBILL Ohrenzange, flaches Maul, 1.2 x 2.5 x 8.0mm, NL 12.5cm <i>DUCKBILL ear forceps, flat jaw, 1.2 x 2.5 x 8.0mm, WL 12.5cm</i>
<b>LC-060-107</b>	DUCKBILL Ohrenzange, flaches Maul, 1.2 x 2.5 x 8.0mm, 45° aufwärts gebogen, NL 8cm <i>DUCKBILL ear forceps, flat jaw, 1.2 x 2.5 x 8.0mm, 45° upward curved, WL 8cm</i>
<b>LC-060-108</b>	DUCKBILL Ohrenzange, flaches Maul, 1.2 x 2.5 x 8.0mm, 45° aufwärts gebogen, NL 12.5cm <i>DUCKBILL ear forceps, flat jaw, 1.2 x 2.5 x 8.0mm, 45° upward curved, WL 12.5cm</i>





**LC-060-075**  
bis / to  
**LC-060-099**



**LC-060-075**  
bis / to  
**LC-060-099**

<b>Bestell-Nr. Ordering no.</b>	<b>Bezeichnung Description</b>
<b>LC-060-075</b>	HARTMANN Ohrenzange, runder Löffel, Ø 0.75mm, NL 8cm HARTMANN ear forceps, round cup, Ø 0.75mm, WL 8cm
<b>LC-060-076</b>	HARTMANN Ohrenzange, runder Löffel, Ø 0.75mm, NL 12.5cm HARTMANN ear forceps, round cup, Ø 0.75mm, WL 12.5cm
<b>LC-060-077</b>	HARTMANN Ohrenzange, runder Löffel, Ø 0.75mm, NL 15cm HARTMANN ear forceps, round cup, Ø 0.75mm, WL 15cm
<b>LC-060-078</b>	HARTMANN Ohrenzange, runder Löffel, Ø 0.75mm, NL 18cm HARTMANN ear forceps, round cup, Ø 0.75mm, WL 18cm
<b>LC-060-079</b>	HARTMANN Ohrenzange, runder Löffel, Ø 1mm, NL 8cm HARTMANN ear forceps, round cup, Ø 1mm, WL 8cm
<b>LC-060-080</b>	HARTMANN Ohrenzange, runder Löffel, Ø 1mm, NL 12.5cm HARTMANN ear forceps, round cup, Ø 1mm, WL 12.5cm
<b>LC-060-081</b>	HARTMANN Ohrenzange, runder Löffel, Ø 1mm, NL 15cm HARTMANN ear forceps, round cup, Ø 1mm, WL 15cm
<b>LC-060-082</b>	HARTMANN Ohrenzange, runder Löffel, Ø 1mm, NL 18cm HARTMANN ear forceps, round cup, Ø 1mm, WL 18cm
<b>LC-060-083</b>	HARTMANN Ohrenzange, runder Löffel, Ø 1.5mm, NL 8cm HARTMANN ear forceps, round cup, Ø 1.5mm, WL 8cm
<b>LC-060-084</b>	HARTMANN Ohrenzange, runder Löffel, Ø 1.5mm, NL 12.5cm HARTMANN ear forceps, round cup, Ø 1.5mm, WL 12.5cm
<b>LC-060-085</b>	HARTMANN Ohrenzange, runder Löffel, Ø 1.5mm, NL 15cm HARTMANN ear forceps, round cup, Ø 1.5mm, WL 15cm
<b>LC-060-087</b>	HARTMANN Ohrenzange, runder Löffel, Ø 1.5mm, NL 18cm HARTMANN ear forceps, round cup, Ø 1.5mm, WL 18cm
<b>LC-060-088</b>	HARTMANN Ohrenzange, runder Löffel, Ø 2mm, NL 8cm HARTMANN ear forceps, round cup, Ø 2mm, WL 8cm
<b>LC-060-089</b>	HARTMANN Ohrenzange, runder Löffel, Ø 2mm, NL 12.5cm HARTMANN ear forceps, round cup, Ø 2mm, WL 12.5cm
<b>LC-060-090</b>	HARTMANN Ohrenzange, runder Löffel, Ø 2mm, NL 15cm HARTMANN ear forceps, round cup, Ø 2mm, WL 15cm
<b>LC-060-091</b>	HARTMANN Ohrenzange, runder Löffel, Ø 2mm, NL 18cm HARTMANN ear forceps, round cup, Ø 2mm, WL 18cm
<b>LC-060-092</b>	HARTMANN Ohrenzange, runder Löffel, Ø 2.5mm, NL 8cm HARTMANN ear forceps, round cup, Ø 2.5mm, WL 8cm
<b>LC-060-093</b>	HARTMANN Ohrenzange, runder Löffel, Ø 2.5mm, NL 12.5cm HARTMANN ear forceps, round cup, Ø 2.5mm, WL 12.5cm
<b>LC-060-094</b>	HARTMANN Ohrenzange, runder Löffel, Ø 2.5mm, NL 15cm HARTMANN ear forceps, round cup, Ø 2.5mm, WL 15cm
<b>LC-060-095</b>	HARTMANN Ohrenzange, runder Löffel, Ø 2.5mm, NL 18cm HARTMANN ear forceps, round cup, Ø 2.5mm, WL 18cm
<b>LC-060-096</b>	HARTMANN Ohrenzange, runder Löffel, Ø 3mm, NL 8cm HARTMANN ear forceps, round cup, Ø 3mm, WL 8cm
<b>LC-060-097</b>	HARTMANN Ohrenzange, runder Löffel, Ø 3mm, NL 12.5cm HARTMANN ear forceps, round cup, Ø 3mm, WL 12.5cm
<b>LC-060-098</b>	HARTMANN Ohrenzange, runder Löffel, Ø 3mm, NL 15cm HARTMANN ear forceps, round cup, Ø 3mm, WL 15cm
<b>LC-060-099</b>	HARTMANN Ohrenzange, runder Löffel, Ø 3mm, NL 18cm HARTMANN ear forceps, round cup, Ø 3mm, WL 18cm

**LC-060-110**  
 bis / to  
**LC-060-133**

**LC-060-110**  
 bis / to  
**LC-060-133**

<b>Bestell-Nr.</b> <b>Ordering no.</b>	<b>Bezeichnung</b> <b>Description</b>
<b>LC-060-110</b>	HARTMANN Ohrenzange, runder Löffel, Ø 0.75mm, 45° aufwärts gebogen, NL 8cm HARTMANN ear forceps, round cup, Ø 0.75mm, upward curved, WL 8cm
<b>LC-060-111</b>	HARTMANN Ohrenzange, runder Löffel, Ø 0.75mm, 45° aufwärts gebogen, NL 12.5cm HARTMANN ear forceps, round cup, Ø 0.75mm, upward curved, WL 12.5cm
<b>LC-060-112</b>	HARTMANN Ohrenzange, runder Löffel, Ø 0.75mm, 45° aufwärts gebogen, NL 15cm HARTMANN ear forceps, round cup, Ø 0.75mm, upward curved, WL 15cm
<b>LC-060-113</b>	HARTMANN Ohrenzange, runder Löffel, Ø 0.75mm, 45° aufwärts gebogen, NL 18cm HARTMANN ear forceps, round cup, Ø 0.75mm, upward curved, WL 18cm
<b>LC-060-114</b>	HARTMANN Ohrenzange, runder Löffel, Ø 1mm, 45° aufwärts gebogen, NL 8cm HARTMANN ear forceps, round cup, Ø 1mm, upward curved, WL 8cm
<b>LC-060-115</b>	HARTMANN Ohrenzange, runder Löffel, Ø 1mm, 45° aufwärts gebogen, NL 12.5cm HARTMANN ear forceps, round cup, Ø 1mm, upward curved, WL 12.5cm
<b>LC-060-116</b>	HARTMANN Ohrenzange, runder Löffel, Ø 1mm, 45° aufwärts gebogen, NL 15cm HARTMANN ear forceps, round cup, Ø 1mm, upward curved, WL 15cm
<b>LC-060-117</b>	HARTMANN Ohrenzange, runder Löffel, Ø 1mm, 45° aufwärts gebogen, NL 18cm HARTMANN ear forceps, round cup, Ø 1mm, upward curved, WL 18cm
<b>LC-060-118</b>	HARTMANN Ohrenzange, runder Löffel, Ø 1.5mm, 45° aufwärts gebogen, NL 8cm HARTMANN ear forceps, round cup, Ø 1.5mm, upward curved, WL 8cm
<b>LC-060-119</b>	HARTMANN Ohrenzange, runder Löffel, Ø 1.5mm, 45° aufwärts gebogen, NL 12.5cm HARTMANN ear forceps, round cup, Ø 1.5mm, upward curved, WL 12.5cm
<b>LC-060-120</b>	HARTMANN Ohrenzange, runder Löffel, Ø 1.5mm, 45° aufwärts gebogen, NL 15cm HARTMANN ear forceps, round cup, Ø 1.5mm, upward curved, WL 15cm
<b>LC-060-121</b>	HARTMANN Ohrenzange, runder Löffel, Ø 1.5mm, 45° aufwärts gebogen, NL 18cm HARTMANN ear forceps, round cup, Ø 1.5mm, upward curved, WL 18cm
<b>LC-060-122</b>	HARTMANN Ohrenzange, runder Löffel, Ø 2mm, 45° aufwärts gebogen, NL 8cm HARTMANN ear forceps, round cup, Ø 2mm, upward curved, WL 8cm
<b>LC-060-123</b>	HARTMANN Ohrenzange, runder Löffel, Ø 2mm, 45° aufwärts gebogen, NL 12.5cm HARTMANN ear forceps, round cup, Ø 2mm, upward curved, WL 12.5cm
<b>LC-060-124</b>	HARTMANN Ohrenzange, runder Löffel, Ø 2mm, 45° aufwärts gebogen, NL 15cm HARTMANN ear forceps, round cup, Ø 2mm, upward curved, WL 15cm
<b>LC-060-125</b>	HARTMANN Ohrenzange, runder Löffel, Ø 2mm, 45° aufwärts gebogen, NL 18cm HARTMANN ear forceps, round cup, Ø 2mm, upward curved, WL 18cm
<b>LC-060-126</b>	HARTMANN Ohrenzange, runder Löffel, Ø 2.5mm, 45° aufwärts gebogen, NL 8cm HARTMANN ear forceps, round cup, Ø 2.5mm, upward curved, WL 8cm
<b>LC-060-127</b>	HARTMANN Ohrenzange, runder Löffel, Ø 2.5mm, 45° aufwärts gebogen, NL 12.5cm HARTMANN ear forceps, round cup, Ø 2.5mm, upward curved, WL 12.5cm
<b>LC-060-128</b>	HARTMANN Ohrenzange, runder Löffel, Ø 2.5mm, 45° aufwärts gebogen, NL 15cm HARTMANN ear forceps, round cup, Ø 2.5mm, upward curved, WL 15cm
<b>LC-060-129</b>	HARTMANN Ohrenzange, runder Löffel, Ø 2.5mm, 45° aufwärts gebogen, NL 18cm HARTMANN ear forceps, round cup, Ø 2.5mm, upward curved, WL 18cm
<b>LC-060-130</b>	HARTMANN Ohrenzange, runder Löffel, Ø 3mm, 45° aufwärts gebogen, NL 8cm HARTMANN ear forceps, round cup, Ø 3mm, upward curved, WL 8cm
<b>LC-060-131</b>	HARTMANN Ohrenzange, runder Löffel, Ø 3mm, 45° aufwärts gebogen, NL 12.5cm HARTMANN ear forceps, round cup, Ø 3mm, upward curved, WL 12.5cm
<b>LC-060-132</b>	HARTMANN Ohrenzange, runder Löffel, Ø 3mm, 45° aufwärts gebogen, NL 15cm HARTMANN ear forceps, round cup, Ø 3mm, upward curved, WL 15cm
<b>LC-060-133</b>	HARTMANN Ohrenzange, runder Löffel, Ø 3mm, 45° aufwärts gebogen, NL 18cm HARTMANN ear forceps, round cup, Ø 3mm, upward curved, WL 18cm



**LC-060-134**  
bis / to  
**LC-060-145**



**LC-060-146 /**  
**LC-060-147**



**LC-060-220**  
bis / to  
**LC-060-222**

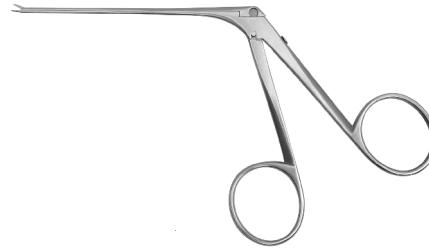

**LC-060-134**  
bis / to  
**LC-060-222**

Bestell-Nr. Ordering no.	Bezeichnung Description
<b>LC-060-134</b>	STRÜMPPEL Ohrenzange, oval gefenstert, 2.5 x 6mm, NL 8cm STRÜMPPEL ear forceps, fenestrated oval, 2.5 x 6mm, WL 8cm
<b>LC-060-135</b>	STRÜMPPEL Ohrenzange, oval gefenstert, 2.5 x 6mm, NL 12.5cm STRÜMPPEL ear forceps, fenestrated oval, 2.5 x 6mm, WL 12.5cm
<b>LC-060-136</b>	STRÜMPPEL Ohrenzange, oval gefenstert, 2.5 x 6mm, NL 15cm STRÜMPPEL ear forceps, fenestrated oval, 2.5 x 6mm, WL 15cm
<b>LC-060-137</b>	STRÜMPPEL Ohrenzange, oval gefenstert, 2.5 x 6mm, NL 18cm STRÜMPPEL ear forceps, fenestrated oval, 2.5 x 6mm, WL 18cm
<b>LC-060-138</b>	STRÜMPPEL Ohrenzange, oval gefenstert, 2.5 x 6mm, 45° aufwärts gebogen, NL 8cm STRÜMPPEL ear forceps, fenestrated oval, 2.5 x 6mm, 45° upward curved, WL 8cm
<b>LC-060-139</b>	STRÜMPPEL Ohrenzange, oval gefenstert, 2.5 x 6mm, 45° aufwärts gebogen, NL 12.5cm STRÜMPPEL ear forceps, fenestrated oval, 2.5 x 6mm, 45° upward curved, WL 12.5cm
<b>LC-060-140</b>	STRÜMPPEL Ohrenzange, oval gefenstert, 2.5 x 6mm, 45° aufwärts gebogen, NL 15cm STRÜMPPEL ear forceps, fenestrated oval, 2.5 x 6mm, 45° upward curved, WL 15cm
<b>LC-060-141</b>	STRÜMPPEL Ohrenzange, oval gefenstert, 2.5 x 6mm, 45° aufwärts gebogen, NL 18cm STRÜMPPEL ear forceps, fenestrated oval, 2.5 x 6mm, 45° upward curved, WL 18cm
<b>LC-060-142</b>	STRÜMPPEL Ohrenzange, oval gefenstert, 2.5 x 6mm, 90° aufwärts gebogen, NL 8cm STRÜMPPEL ear forceps, fenestrated oval, 2.5 x 6mm, 90° upward curved, WL 8cm
<b>LC-060-143</b>	STRÜMPPEL Ohrenzange, oval gefenstert, 2.5 x 6mm, 90° aufwärts gebogen, NL 12.5cm STRÜMPPEL ear forceps, fenestrated oval, 2.5 x 6mm, 90° upward curved, WL 12.5cm
<b>LC-060-144</b>	STRÜMPPEL Ohrenzange, oval gefenstert, 2.5 x 6mm, 90° aufwärts gebogen, NL 15cm STRÜMPPEL ear forceps, fenestrated oval, 2.5 x 6mm, 90° upward curved, WL 15cm
<b>LC-060-145</b>	STRÜMPPEL Ohrenzange, oval gefenstert, 2.5 x 6mm, 90° aufwärts gebogen, NL 15cm STRÜMPPEL ear forceps, fenestrated oval, 2.5 x 6mm, 90° upward curved, WL 15cm
<b>LC-060-146</b>	STRÜMPPEL Biopsie- und Fasszange, oval gefenstert, 2.5 x 6mm, Absaugkanal, NL 12.5cm STRÜMPPEL biopsy and grasping forceps, fenestrated oval, 2.5 x 6mm, suction channel, WL 12.5cm
<b>LC-060-147</b>	STRÜMPPEL Biopsie- und Fasszange, oval gefenstert, 2.5 x 6mm, 45° aufwärts gebogen, Absaugkanal, NL 12.5cm STRÜMPPEL biopsy and grasping forceps, fenestrated oval, 2.5 x 6mm, 45° upward curved, suction channel, WL 12.5cm
<b>LC-060-220</b>	WULLSTEIN Ohrzange, extra zart, ovaler Löffel, Ø 0.6mm, rechts gebogen, NL 8cm WULLSTEIN ear forceps, extra fine, oval spoon, Ø 0.6mm, curved right, WL 8cm
<b>LC-060-221</b>	WULLSTEIN Ohrzange, extra zart, ovaler Löffel, Ø 0.6mm, links gebogen, NL 8cm WULLSTEIN ear forceps, extra fine, oval spoon, Ø 0.6mm, curved left, WL 8cm
<b>LC-060-222</b>	WULLSTEIN Ohrzange, extra zart, ovaler Löffel, Ø 0.6mm, aufwärts gebogen, NL 8cm WULLSTEIN ear forceps, extra fine, oval spoon, Ø 0.6mm, upward curved, WL 8cm



**LC-060-150**  
bis / to  
**LC-060-169**



**LC-060-150**  
bis / to  
**LC-060-169**

<b>Bestell-Nr.</b> <b>Ordering no.</b>	<b>Bezeichnung</b> <b>Description</b>
<b>LC-060-150</b>	Mikro Ohrenzange, zart, 1.8 x 0.9 x 4.5mm, NL 8cm <i>Micro ear forceps, delicate, 1.8 x 0.9 x 4.5mm, WL 8cm</i>
<b>LC-060-151</b>	Mikro Ohrenzange, zart, 1.8 x 0.9 x 4.5mm, NL 12.5cm <i>Micro ear forceps, delicate, 1.8 x 0.9 x 4.5mm, WL 12.5cm</i>
<b>LC-060-152</b>	Mikro Ohrenzange, zart, 1.8 x 0.9 x 4.5mm, NL 15cm <i>Micro ear forceps, delicate, 1.8 x 0.9 x 4.5mm, WL 15cm</i>
<b>LC-060-153</b>	Mikro Ohrenzange, zart, 1.8 x 0.9 x 4.5mm, NL 18cm <i>Micro ear forceps, delicate, 1.8 x 0.9 x 4.5mm, WL 18cm</i>
<b>LC-060-154</b>	Mikro Ohrenzange, zart, 1.8 x 0.9 x 4.5mm, rechts gebogen, NL 8cm <i>Micro ear forceps, delicate, 1.8 x 0.9 x 4.5mm, curved right, WL 8cm</i>
<b>LC-060-155</b>	Mikro Ohrenzange, zart, 1.8 x 0.9 x 4.5mm, rechts gebogen, NL 12.5cm <i>Micro ear forceps, delicate, 1.8 x 0.9 x 4.5mm, curved right, WL 12.5cm</i>
<b>LC-060-156</b>	Mikro Ohrenzange, zart, 1.8 x 0.9 x 4.5mm, rechts gebogen, NL 15cm <i>Micro ear forceps, delicate, 1.8 x 0.9 x 4.5mm, curved right, WL 15cm</i>
<b>LC-060-157</b>	Mikro Ohrenzange, zart, 1.8 x 0.9 x 4.5mm, rechts gebogen, NL 18cm <i>Micro ear forceps, delicate, 1.8 x 0.9 x 4.5mm, curved right, WL 18cm</i>
<b>LC-060-158</b>	Mikro Ohrenzange, zart, 1.8 x 0.9 x 4.5mm, links gebogen, NL 8cm <i>Micro ear forceps, delicate, 1.8 x 0.9 x 4.5mm, curved left, WL 8cm</i>
<b>LC-060-159</b>	Mikro Ohrenzange, zart, 1.8 x 0.9 x 4.5mm, links gebogen, NL 12.5cm <i>Micro ear forceps, delicate, 1.8 x 0.9 x 4.5mm, curved left, WL 12.5cm</i>
<b>LC-060-160</b>	Mikro Ohrenzange, zart, 1.8 x 0.9 x 4.5mm, links gebogen, NL 15cm <i>Micro ear forceps, delicate, 1.8 x 0.9 x 4.5mm, curved left, WL 15cm</i>
<b>LC-060-161</b>	Mikro Ohrenzange, zart, 1.8 x 0.9 x 4.5mm, links gebogen, NL 18cm <i>Micro ear forceps, delicate, 1.8 x 0.9 x 4.5mm, curved left, WL 18cm</i>
<b>LC-060-162</b>	Mikro Ohrenzange, zart, 1.8 x 0.9 x 4.5mm, aufwärts gebogen, NL 8cm <i>Micro ear forceps, delicate, 1.8 x 0.9 x 4.5mm, upward curved, WL 8cm</i>
<b>LC-060-163</b>	Mikro Ohrenzange, zart, 1.8 x 0.9 x 4.5mm, aufwärts gebogen, NL 12.5cm <i>Micro ear forceps, delicate, 1.8 x 0.9 x 4.5mm, upward curved, WL 12.5cm</i>
<b>LC-060-164</b>	Mikro Ohrenzange, zart, 1.8 x 0.9 x 4.5mm, aufwärts gebogen, NL 15cm <i>Micro ear forceps, delicate, 1.8 x 0.9 x 4.5mm, upward curved, WL 15cm</i>
<b>LC-060-165</b>	Mikro Ohrenzange, zart, 1.8 x 0.9 x 4.5mm, aufwärts gebogen, NL 18cm <i>Micro ear forceps, delicate, 1.8 x 0.9 x 4.5mm, upward curved, WL 18cm</i>
<b>LC-060-166</b>	Mikro Ohrenzange, zart, 1.8 x 0.9 x 4.5mm, abwärts gebogen, NL 8cm <i>Micro ear forceps, delicate, 1.8 x 0.9 x 4.5mm, downward curved, WL 8cm</i>
<b>LC-060-167</b>	Mikro Ohrenzange, zart, 1.8 x 0.9 x 4.5mm, abwärts gebogen, NL 12.5cm <i>Micro ear forceps, delicate, 1.8 x 0.9 x 4.5mm, downward curved, WL 12.5cm</i>
<b>LC-060-168</b>	Mikro Ohrenzange, zart, 1.8 x 0.9 x 4.5mm, abwärts gebogen, NL 15cm <i>Micro ear forceps, delicate, 1.8 x 0.9 x 4.5mm, downward curved, WL 15cm</i>
<b>LC-060-169</b>	Mikro Ohrenzange, zart, 1.8 x 0.9 x 4.5mm, abwärts gebogen, NL 18cm <i>Micro ear forceps, delicate, 1.8 x 0.9 x 4.5mm, downward curved, WL 18cm</i>



**LC-060-180**  
bis / to  
**LC-060-199**



**LC-060-180**  
bis / to  
**LC-060-199**

<b>Bestell-Nr.</b> <b>Ordering no.</b>	<b>Bezeichnung</b> <b>Description</b>
<b>LC-060-180</b>	Mikro Ohrenzange, sehr zart, 1.8 x 0.6 x 4.5mm, NL 8cm <i>Micro ear forceps, very delicate, 1.8 x 0.6 x 4.5mm, WL 8cm</i>
<b>LC-060-181</b>	Mikro Ohrenzange, sehr zart, 1.8 x 0.6 x 4.5mm, NL 12.5cm <i>Micro ear forceps, very delicate, 1.8 x 0.6 x 4.5mm, WL 12.5cm</i>
<b>LC-060-182</b>	Mikro Ohrenzange, sehr zart, 1.8 x 0.6 x 4.5mm, NL 15cm <i>Micro ear forceps, very delicate, 1.8 x 0.6 x 4.5mm, WL 15cm</i>
<b>LC-060-183</b>	Mikro Ohrenzange, sehr zart, 1.8 x 0.6 x 4.5mm, NL 18cm <i>Micro ear forceps, very delicate, 1.8 x 0.6 x 4.5mm, WL 18cm</i>
<b>LC-060-184</b>	Mikro Ohrenzange, sehr zart, 1.8 x 0.6 x 4.5mm, rechts gebogen, NL 8cm <i>Micro ear forceps, very delicate, 1.8 x 0.6 x 4.5mm, curved right, WL 8cm</i>
<b>LC-060-185</b>	Mikro Ohrenzange, sehr zart, 1.8 x 0.6 x 4.5mm, rechts gebogen, NL 12.5cm <i>Micro ear forceps, very delicate, 1.8 x 0.6 x 4.5mm, curved right, WL 12.5cm</i>
<b>LC-060-186</b>	Mikro Ohrenzange, sehr zart, 1.8 x 0.6 x 4.5mm, rechts gebogen, NL 15cm <i>Micro ear forceps, very delicate, 1.8 x 0.6 x 4.5mm, curved right, WL 15cm</i>
<b>LC-060-187</b>	Mikro Ohrenzange, sehr zart, 1.8 x 0.6 x 4.5mm, rechts gebogen, NL 18cm <i>Micro ear forceps, very delicate, 1.8 x 0.6 x 4.5mm, curved right, WL 18cm</i>
<b>LC-060-188</b>	Mikro Ohrenzange, sehr zart, 1.8 x 0.6 x 4.5mm, links gebogen, NL 8cm <i>Micro ear forceps, very delicate, 1.8 x 0.6 x 4.5mm, curved left, WL 8cm</i>
<b>LC-060-189</b>	Mikro Ohrenzange, sehr zart, 1.8 x 0.6 x 4.5mm, links gebogen, NL 12.5cm <i>Micro ear forceps, very delicate, 1.8 x 0.6 x 4.5mm, curved left, WL 12.5cm</i>
<b>LC-060-190</b>	Mikro Ohrenzange, sehr zart, 1.8 x 0.6 x 4.5mm, links gebogen, NL 15cm <i>Micro ear forceps, very delicate, 1.8 x 0.6 x 4.5mm, curved left, WL 15cm</i>
<b>LC-060-191</b>	Mikro Ohrenzange, sehr zart, 1.8 x 0.6 x 4.5mm, links gebogen, NL 18cm <i>Micro ear forceps, very delicate, 1.8 x 0.6 x 4.5mm, curved left, WL 18cm</i>
<b>LC-060-192</b>	Mikro Ohrenzange, sehr zart, 1.8 x 0.6 x 4.5mm, aufwärts gebogen, NL 8cm <i>Micro ear forceps, very delicate, 1.8 x 0.6 x 4.5mm, upward curved, WL 8cm</i>
<b>LC-060-193</b>	Mikro Ohrenzange, sehr zart, 1.8 x 0.6 x 4.5mm, aufwärts gebogen, NL 12.5cm <i>Micro ear forceps, very delicate, 1.8 x 0.6 x 4.5mm, upward curved, WL 12.5cm</i>
<b>LC-060-194</b>	Mikro Ohrenzange, sehr zart, 1.8 x 0.6 x 4.5mm, aufwärts gebogen, NL 15cm <i>Micro ear forceps, very delicate, 1.8 x 0.6 x 4.5mm, upward curved, WL 15cm</i>
<b>LC-060-195</b>	Mikro Ohrenzange, sehr zart, 1.8 x 0.6 x 4.5mm, aufwärts gebogen, NL 18cm <i>Micro ear forceps, very delicate, 1.8 x 0.6 x 4.5mm, upward curved, WL 18cm</i>
<b>LC-060-196</b>	Mikro Ohrenzange, sehr zart, 1.8 x 0.6 x 4.5mm, abwärts gebogen, NL 8cm <i>Micro ear forceps, very delicate, 1.8 x 0.6 x 4.5mm, downward curved, WL 8cm</i>
<b>LC-060-197</b>	Mikro Ohrenzange, sehr zart, 1.8 x 0.6 x 4.5mm, abwärts gebogen, NL 8cm <i>Micro ear forceps, very delicate, 1.8 x 0.6 x 4.5mm, downward curved, WL 8cm</i>
<b>LC-060-198</b>	Mikro Ohrenzange, sehr zart, 1.8 x 0.6 x 4.5mm, abwärts gebogen, NL 8cm <i>Micro ear forceps, very delicate, 1.8 x 0.6 x 4.5mm, downward curved, WL 8cm</i>
<b>LC-060-199</b>	Mikro Ohrenzange, sehr zart, 1.8 x 0.6 x 4.5mm, abwärts gebogen, NL 8cm <i>Micro ear forceps, very delicate, 1.8 x 0.6 x 4.5mm, downward curved, WL 8cm</i>





**LC-070-001**  
bis / to  
**LC-070-004**



**LC-070-010**  
bis / to  
**LC-070-013**



**LC-070-005**  
bis / to  
**LC-070-008**



**LC-070-014**  
bis / to  
**LC-070-016**



**LC-070-009**



**LC-070-017**



**LC-070-001**  
bis / to  
**LC-070-004**

Bestell-Nr. Ordering no.	Bezeichnung Description
<b>LC-070-001</b>	Mikro Faszange, gerieft, gerade, Maulteil Ø 2.4mm, Schaft Ø 1.5mm, AL 7cm <i>Micro grasping forceps, serrated, straight, jaw Ø 2.4mm, tube Ø 1.5mm, WL 7cm</i>
<b>LC-070-002</b>	Mikro Faszange, gerieft, aufgebogen, Maulteil Ø 2.4mm, Schaft Ø 1.5mm, AL 7cm <i>Micro grasping forceps, serrated, upward curved, jaw Ø 2.4mm, tube Ø 1.5mm, WL 7cm</i>
<b>LC-070-003</b>	Mikro Faszange, gerieft, rechts gebogen, Maulteil Ø 2.4mm, Schaft Ø 1.5mm, AL 7cm <i>Micro grasping forceps, serrated, curved right, jaw Ø 2.4mm, tube Ø 1.5mm, WL 7cm</i>
<b>LC-070-004</b>	Mikro Faszange, gerieft, links gebogen, Maulteil Ø 2.4mm, Schaft Ø 1.5mm, AL 7cm <i>Micro grasping forceps, serrated, curved left, jaw Ø 2.4mm, tube Ø 1.5mm, WL 7cm</i>
<b>LC-070-005</b>	ALLIGATOR Mikro Faszange, gerade, Maulteil Ø 2.4mm, Schaft Ø 1.5mm, AL 7cm <i>ALLIGATOR micro grasping forceps, straight, jaw Ø 2.4mm, tube Ø 1.5mm, WL 7cm</i>
<b>LC-070-006</b>	ALLIGATOR Mikro Faszange, aufgebogen, Maulteil Ø 2.4mm, Schaft Ø 1.5mm, AL 7cm <i>ALLIGATOR micro grasping forceps, upward curved, jaw Ø 2.4mm, tube Ø 1.5mm, WL 7cm</i>
<b>LC-070-007</b>	ALLIGATOR Mikro Faszange, rechts gebogen, Maulteil Ø 2.4mm, Schaft Ø 1.5mm, AL 7cm <i>ALLIGATOR micro grasping forceps, curved right, jaw Ø 2.4mm, tube Ø 1.5mm, WL 7cm</i>
<b>LC-070-008</b>	ALLIGATOR Mikro Faszange, links gebogen, Maulteil Ø 2.4mm, Schaft Ø 1.5mm, AL 7cm <i>ALLIGATOR micro grasping forceps, curved left, jaw Ø 2.4mm, tube Ø 1.5mm, WL 7cm</i>
<b>LC-070-009</b>	MAUSZAHN Mikro Faszange, 1x2 Zähne, gerade, Maulteil Ø 2.4mm, Schaft Ø 1.5mm, AL 7cm <i>MOUSETEETH micro grasping forceps, 1x2 teeth, straight, jaw Ø 2.4mm, tube 1.5mm, WL 7cm</i>
<b>LC-070-010</b>	Mikro Faszange, fein gerieft, gerade, Maulteil Ø 1.7mm, Schaft Ø 0.9mm, AL 7cm <i>Micro grasping fine forceps serrated, straight, jaw Ø 1.7mm, tube Ø 0.9mm, WL 7cm</i>
<b>LC-070-011</b>	Mikro Faszange, fein gerieft, aufgebogen, Maulteil Ø 1.7mm, Schaft Ø 0.9mm, AL 7cm <i>Micro grasping fine forceps serrated, upward curved, jaw Ø 1.7mm, tube Ø 0.9mm, WL 7cm</i>
<b>LC-070-012</b>	Mikro Faszange, fein gerieft, rechts gebogen, Maulteil Ø 1.7mm, Schaft Ø 0.9mm, AL 7cm <i>Micro grasping fine forceps serrated, curved right, jaw Ø 1.7mm, tube Ø 0.9mm, WL 7cm</i>
<b>LC-070-013</b>	Mikro Faszange, fein gerieft, links gebogen, Maulteil Ø 1.7mm, Schaft Ø 0.9mm, AL 7cm <i>Micro grasping fine forceps serrated, curved left, jaw Ø 1.7mm, tube Ø 0.9mm, WL 7cm</i>
<b>LC-070-014</b>	ALLIGATOR Mikro Faszange, fein, gerade, Maulteil Ø 1.7mm, Schaft Ø 0.9mm, AL 7cm <i>ALLIGATOR micro grasping forceps, fine, straight, jaw Ø 1.7mm, tube Ø 0.9mm, WL 7cm</i>
<b>LC-070-015</b>	ALLIGATOR Mikro Faszange, fein, rechts gebogen, Maulteil Ø 1.7mm, Schaft Ø 0.9mm, AL 7cm <i>ALLIGATOR micro grasping forceps, fine, curved right, jaw Ø 1.7mm, tube Ø 0.9mm, WL 7cm</i>
<b>LC-070-016</b>	ALLIGATOR Mikro Faszange, fein, links gebogen, Maulteil Ø 1.7mm, Schaft Ø 0.9mm, AL 7cm <i>ALLIGATOR micro grasping forceps, fine, curved left, jaw Ø 1.7mm, tube Ø 0.9mm, WL 7cm</i>
<b>LC-070-017</b>	MAUSZAHN Mikro Faszange, 1x2 Zähne, fein, gerade, Maulteil Ø 1.7mm, Schaft Ø 0.9mm, AL 7cm <i>MOUSETEETH micro grasping forceps, 1x2 teeth, fine, straight, jaw Ø 1.7mm, tube 0.9mm, WL 7cm</i>



**LC-070-020**  
bis / to  
**LC-070-035**



**LC-070-020**  
bis / to  
**LC-070-035**

<b>Bestell-Nr.</b> <b>Ordering no.</b>	<b>Bezeichnung</b> <b>Description</b>
<b>LC-070-020</b>	Mikro Löffelzange, gerade, Maulteil Ø 1.0mm, Schaft Ø 1.5mm, AL 7cm <i>Micro spoon forceps, straight, jaw Ø 1.0mm, tube Ø 1.5mm, WL 7cm</i>
<b>LC-070-021</b>	Mikro Löffelzange, aufwärts gebogen, Maulteil Ø 1.0mm, Schaft Ø 1.5mm, AL 7cm <i>Micro spoon forceps, upward curved, jaw Ø 1.0mm, tube Ø 1.5mm, WL 7cm</i>
<b>LC-070-022</b>	Mikro Löffelzange, rechts gebogen, Maulteil Ø 1.0mm, Schaft Ø 1.5mm, AL 7cm <i>Micro spoon forceps, curved right, jaw Ø 1.0mm, tube Ø 1.5mm, WL 7cm</i>
<b>LC-070-023</b>	Mikro Löffelzange, links gebogen, Maulteil Ø 1.0mm, Schaft Ø 1.5mm, AL 7cm <i>Micro spoon forceps, curved left, jaw Ø 1.0mm, tube Ø 1.5mm, WL 7cm</i>
<b>LC-070-024</b>	Mikro Löffelzange, gerade, Maulteil Ø 1.5mm, Schaft Ø 1.5mm, AL 7cm <i>Micro spoon forceps, straight, jaw Ø 1.5mm, tube Ø 1.5mm, WL 7cm</i>
<b>LC-070-025</b>	Mikro Löffelzange, aufwärts gebogen, Maulteil Ø 1.5mm, Schaft Ø 1.5mm, AL 7cm <i>Micro spoon forceps, upward curved, jaw Ø 1.5mm, tube Ø 1.5mm, WL 7cm</i>
<b>LC-070-026</b>	Mikro Löffelzange, rechts gebogen, Maulteil Ø 1.5mm, Schaft Ø 1.5mm, AL 7cm <i>Micro spoon forceps, curved right, jaw Ø 1.5mm, tube Ø 1.5mm, WL 7cm</i>
<b>LC-070-027</b>	Mikro Löffelzange, links gebogen, Maulteil Ø 1.5mm, Schaft Ø 1.5mm, AL 7cm <i>Micro spoon forceps, curved left, jaw Ø 1.5mm, tube Ø 1.5mm, WL 7cm</i>
<b>LC-070-028</b>	Mikro Löffelzange, gerade, Maulteil Ø 2.0mm, Schaft Ø 1.5mm, AL 7cm <i>Micro spoon forceps, straight, jaw Ø 2.0mm, tube Ø 1.5mm, WL 7cm</i>
<b>LC-070-029</b>	Mikro Löffelzange, aufwärts gebogen, Maulteil Ø 2.0mm, Schaft Ø 1.5mm, AL 7cm <i>Micro spoon forceps, upward curved, jaw Ø 2.0mm, tube Ø 1.5mm, WL 7cm</i>
<b>LC-070-030</b>	Mikro Löffelzange, rechts gebogen, Maulteil Ø 2.0mm, Schaft Ø 1.5mm, AL 7cm <i>Micro spoon forceps, curved right, jaw Ø 2.0mm, tube Ø 1.5mm, WL 7cm</i>
<b>LC-070-031</b>	Mikro Löffelzange, links gebogen, Maulteil Ø 2.0mm, Schaft Ø 1.5mm, AL 7cm <i>Micro spoon forceps, curved left, jaw Ø 2.0mm, tube Ø 1.5mm, WL 7cm</i>
<b>LC-070-032</b>	Mikro Löffelzange, gerade, Maulteil Ø 2.5mm, Schaft Ø 1.5mm, AL 7cm <i>Micro spoon forceps, straight, jaw Ø 2.5mm, tube Ø 1.5mm, WL 7cm</i>
<b>LC-070-033</b>	Mikro Löffelzange, aufwärts gebogen, Maulteil Ø 2.5mm, Schaft Ø 1.5mm, AL 7cm <i>Micro spoon forceps, upward curved, jaw Ø 2.5mm, tube Ø 1.5mm, WL 7cm</i>
<b>LC-070-034</b>	Mikro Löffelzange, rechts gebogen, Maulteil Ø 2.5mm, Schaft Ø 1.5mm, AL 7cm <i>Micro spoon forceps, curved right, jaw Ø 2.5mm, tube Ø 1.5mm, WL 7cm</i>
<b>LC-070-035</b>	Mikro Löffelzange, links gebogen, Maulteil Ø 2.5mm, Schaft Ø 1.5mm, AL 7cm <i>Micro spoon forceps, curved left, jaw Ø 2.5mm, tube Ø 1.5mm, WL 7cm</i>





**LC-070-036**  
bis / to  
**LC-070-047**



**LC-070-036**  
bis / to  
**LC-070-047**

<b>Bestell-Nr.</b> <b>Ordering no.</b>	<b>Bezeichnung</b> <b>Description</b>
<b>LC-070-036</b>	Mikro Löffelzange, oval, gerade, Schaft Ø 1.5mm, AL 7cm <i>Micro spoon forceps, oval, straight, tube Ø 1.5mm, WL 7cm</i>
<b>LC-070-037</b>	Mikro Löffelzange, oval, aufwärts gebogen, Schaft Ø 1.5mm, AL 7cm <i>Micro spoon forceps, oval, upward curved, tube Ø 1.5mm, WL 7cm</i>
<b>LC-070-038</b>	Mikro Löffelzange, oval, rechts gebogen, Schaft Ø 1.5mm, AL 7cm <i>Micro spoon forceps, oval, curved right, tube Ø 1.5mm, WL 7cm</i>
<b>LC-070-039</b>	Mikrolöffelzange, oval, links gebogen, Schaft Ø 1.5mm, AL 7cm <i>Micro spoon forceps, oval, curved left, tube Ø 1.5mm, WL 7cm</i>
<b>LC-070-040</b>	Mikro Löffelzange, fein, gerade, Maulteil Ø 1.7mm, Schaft Ø 0.9mm, AL 7cm <i>Micro spoon forceps, fine, straight, jaw Ø 1.7mm, tube Ø 0.9mm, WL 7cm</i>
<b>LC-070-041</b>	Mikro Löffelzange, fein, aufwärts gebogen, Maulteil Ø 1.7mm, Schaft Ø 0.9mm, AL 7cm <i>Micro spoon forceps, fine, upward curved, jaw Ø 1.7mm, tube Ø 0.9mm, WL 7cm</i>
<b>LC-070-042</b>	Mikro Löffelzange, fein, rechts gebogen, Maulteil Ø 1.7mm, Schaft Ø 0.9mm, AL 7cm <i>Micro spoon forceps, fine, curved right, jaw Ø 1.7mm, tube Ø 0.9mm, WL 7cm</i>
<b>LC-070-043</b>	Mikro Löffelzange, fein, links gebogen, Maulteil Ø 1.7mm, Schaft Ø 0.9mm, AL 7cm <i>Micro spoon forceps, fine, curved left, jaw Ø 1.7mm, tube Ø 0.9mm, WL 7cm</i>
<b>LC-070-044</b>	Mikro Löffelzange, oval, fein, gerade, Schaft Ø 1.5mm, AL 7cm <i>Micro spoon forceps, oval, fine, straight, tube Ø 1.5mm, WL 7cm</i>
<b>LC-070-045</b>	Mikro Löffelzange, oval, fein, aufwärts gebogen, Schaft Ø 1.5mm, AL 7cm <i>Micro spoon forceps, oval, fine, upward curved, tube Ø 1.5mm, WL 7cm</i>
<b>LC-070-046</b>	Mikro Löffelzange, oval, fein, rechts gebogen, Schaft Ø 1.5mm, AL 7cm <i>Micro spoon forceps, oval, fine, curved right, tube Ø 1.5mm, WL 7cm</i>
<b>LC-070-047</b>	Mikro Löffelzange, oval, fein, links gebogen, Schaft Ø 1.5mm, AL 7cm <i>Micro spoon forceps, oval, fine, curved left, tube Ø 1.5mm, WL 7cm</i>

**LC-007-010**  
bis / to  
**LC-007-033**



**LC-007-010**  
bis / to  
**LC-007-033**

**LC-007-066**  
bis / to  
**LC-007-072**



**LC-007-066**  
bis / to  
**LC-007-072**

Bestell-Nr. Ordering no.	Bezeichnung Description
<b>LC-007-010</b>	BELLUCCI Schere, gerade, NL 10cm <i>BELLUCCI scissors, straight, WL 10cm</i>
<b>LC-007-011</b>	BELLUCCI Scherchen, zartes Modell, Schnittlänge 8mm, NL 8cm <i>BELLUCCI scissors, fine modell, cutting length 8mm, WL 8cm</i>
<b>LC-007-012</b>	BELLUCCI Scherchen, Schnittlänge 8mm, NL 8cm <i>BELLUCCI scissors, cutting length 8mm, WL 8cm</i>
<b>LC-007-013</b>	BELLUCCI Scherchen, extra fein, Schnittlänge 7mm, NL 8cm <i>BELLUCCI scissors, extra fine, cutting length 7mm, WL 8cm</i>
<b>LC-007-015</b>	BELLUCCI Schere, gerade, NL 12.5cm <i>BELLUCCI scissors, straight, WL 12.5cm</i>
<b>LC-007-030</b>	BELLUCCI Scherchen, zartes Modell, Schnittlänge 3mm, NL 8cm <i>BELLUCCI scissors, fine modell, cutting length 3mm, WL 8cm</i>
<b>LC-007-031</b>	BELLUCCI Scherchen, zartes Modell, Schnittlänge 3mm, NL 12.5cm <i>BELLUCCI scissors, fine modell, cutting length 3mm, WL 12.5cm</i>
<b>LC-007-032</b>	BELLUCCI Scherchen, zartes Modell, Schnittlänge 3mm, NL 15cm <i>BELLUCCI scissors, fine modell, cutting length 3mm, WL 15cm</i>
<b>LC-007-033</b>	BELLUCCI Scherchen, zartes Modell, Schnittlänge 3mm, NL 18cm <i>BELLUCCI scissors, fine modell, cutting length 3mm, WL 18cm</i>
<b>LC-007-066</b>	WULLSTEIN Scherchen, extra zart, NL 8cm <i>WULLSTEIN scissors, extra fine, WL 8cm</i>
<b>LC-007-067</b>	WULLSTEIN Scherchen, extra zart, NL 9cm <i>WULLSTEIN scissors, extra fine, WL 9cm</i>
<b>LC-007-068</b>	WULLSTEIN Scherchen, zart, rechts gebogen, NL 9cm <i>WULLSTEIN scissors, fine, curved right, WL 9cm</i>
<b>LC-007-069</b>	WULLSTEIN Scherchen, zart, links gebogen, NL 9cm <i>WULLSTEIN scissors, fine, curved left, WL 9cm</i>
<b>LC-007-070</b>	WULLSTEIN Scherchen, zart, aufwärts gebogen, NL 9cm <i>WULLSTEIN scissors, fine, upward curved, WL 9cm</i>
<b>LC-007-071</b>	FISCH Scherchen zur Crurotomie, links gebogen, Schnittlänge 3mm, NL 8cm <i>FISCH crurotomy scissors, curved left, cutting length 3mm, WL 8cm</i>
<b>LC-007-072</b>	FISCH Scherchen zur Crurotomie, rechts gebogen, Schnittlänge 3mm, NL 8cm <i>FISCH crurotomy scissors, curved right, cutting length 3mm, WL 8cm</i>



**LC-007-034**  
bis / to  
**LC-007-049**



**LC-007-034**  
bis / to  
**LC-007-049**

<b>Bestell-Nr.</b> <b>Ordering no.</b>	<b>Bezeichnung</b> <b>Description</b>
<b>LC-007-034</b>	BELLUCCI Scherchen, Schnittlänge 5mm, NL 8cm <i>BELLUCCI scissors, cutting length 5mm, WL 8cm</i>
<b>LC-007-035</b>	BELLUCCI Scherchen, Schnittlänge 5mm, NL 12.5cm <i>BELLUCCI scissors, cutting length 5mm, WL 12.5cm</i>
<b>LC-007-036</b>	BELLUCCI Scherchen, Schnittlänge 5mm, NL 15cm <i>BELLUCCI scissors, cutting length 5mm, WL 15cm</i>
<b>LC-007-037</b>	BELLUCCI Scherchen, Schnittlänge 5mm, NL 18cm <i>BELLUCCI scissors, cutting length 5mm, WL 18cm</i>
<b>LC-007-038</b>	BELLUCCI Scherchen, rechts gebogen, Schnittlänge 5mm, NL 8cm <i>BELLUCCI scissors, curved right, cutting length 5mm, WL 8cm</i>
<b>LC-007-039</b>	BELLUCCI Scherchen, rechts gebogen, Schnittlänge 5mm, NL 12.5cm <i>BELLUCCI scissors, curved right, cutting length 5mm, WL 12.5cm</i>
<b>LC-007-040</b>	BELLUCCI Scherchen, rechts gebogen, Schnittlänge 5mm, NL 15cm <i>BELLUCCI scissors, curved right, cutting length 5mm, WL 15cm</i>
<b>LC-007-041</b>	BELLUCCI Scherchen, rechts gebogen, Schnittlänge 5mm, NL 18cm <i>BELLUCCI scissors, curved right, cutting length 5mm, WL 18cm</i>
<b>LC-007-042</b>	BELLUCCI Scherchen, links gebogen, Schnittlänge 5mm, NL 8cm <i>BELLUCCI scissors, curved left, cutting length 5mm, WL 8cm</i>
<b>LC-007-043</b>	BELLUCCI Scherchen, links gebogen, Schnittlänge 5mm, NL 12.5cm <i>BELLUCCI scissors, curved left, cutting length 5mm, WL 12.5cm</i>
<b>LC-007-044</b>	BELLUCCI Scherchen, links gebogen, Schnittlänge 5mm, NL 15cm <i>BELLUCCI scissors, curved left, cutting length 5mm, WL 15cm</i>
<b>LC-007-045</b>	BELLUCCI Scherchen, links gebogen, Schnittlänge 5mm, NL 18cm <i>BELLUCCI scissors, curved left, cutting length 5mm, WL 18cm</i>
<b>LC-007-046</b>	BELLUCCI Scherchen, aufwärts gebogen, Schnittlänge 5mm, NL 8cm <i>BELLUCCI scissors, upward curved, cutting length 5mm, WL 8cm</i>
<b>LC-007-047</b>	BELLUCCI Scherchen, aufwärts gebogen, Schnittlänge 5mm, NL 12.5cm <i>BELLUCCI scissors, upward curved, cutting length 5mm, WL 12.5cm</i>
<b>LC-007-048</b>	BELLUCCI Scherchen, aufwärts gebogen, Schnittlänge 5mm, NL 15cm <i>BELLUCCI scissors, upward curved, cutting length 5mm, WL 15cm</i>
<b>LC-007-049</b>	BELLUCCI Scherchen, aufwärts gebogen, Schnittlänge 5mm, NL 18cm <i>BELLUCCI scissors, upward curved, cutting length 5mm, WL 18cm</i>



**LC-007-050**  
bis / to  
**LC-007-065**



**LC-007-050**  
bis / to  
**LC-007-065**

<b>Bestell-Nr. Ordering no.</b>	<b>Bezeichnung Description</b>
<b>LC-007-050</b>	SHEA-BELLUCCI Scherchen, Schnittlänge 7mm, NL 8cm <i>SHEA-BELLUCCI scissors, cutting length 7mm, WL 8cm</i>
<b>LC-007-051</b>	SHEA-BELLUCCI Scherchen, Schnittlänge 7mm, NL 12.5cm <i>SHEA-BELLUCCI scissors, cutting length 7mm, WL 12.5cm</i>
<b>LC-007-052</b>	SHEA-BELLUCCI Scherchen, Schnittlänge 7mm, NL 15cm <i>SHEA-BELLUCCI scissors, cutting length 7mm, WL 15cm</i>
<b>LC-007-053</b>	SHEA-BELLUCCI Scherchen, Schnittlänge 7mm, NL 18cm <i>SHEA-BELLUCCI scissors, cutting length 7mm, WL 18cm</i>
<b>LC-007-054</b>	SHEA-BELLUCCI Scherchen, rechts gebogen, Schnittlänge 7mm, NL 8cm <i>SHEA-BELLUCCI scissors, curved right, cutting length 7mm, WL 8cm</i>
<b>LC-007-055</b>	SHEA-BELLUCCI Scherchen, rechts gebogen, Schnittlänge 7mm, NL 12.5cm <i>SHEA-BELLUCCI scissors, curved right, cutting length 7mm, WL 12.5cm</i>
<b>LC-007-056</b>	SHEA-BELLUCCI Scherchen, rechts gebogen, Schnittlänge 7mm, NL 15cm <i>SHEA-BELLUCCI scissors, curved right, cutting length 7mm, WL 15cm</i>
<b>LC-007-057</b>	SHEA-BELLUCCI Scherchen, rechts gebogen, Schnittlänge 7mm, NL 18cm <i>SHEA-BELLUCCI scissors, curved right, cutting length 7mm, WL 18cm</i>
<b>LC-007-058</b>	SHEA-BELLUCCI Scherchen, links gebogen, Schnittlänge 7mm, NL 8cm <i>SHEA-BELLUCCI scissors, curved left, cutting length 7mm, WL 8cm</i>
<b>LC-007-059</b>	SHEA-BELLUCCI Scherchen, links gebogen, Schnittlänge 7mm, NL 12.5cm <i>SHEA-BELLUCCI scissors, curved left, cutting length 7mm, WL 12.5cm</i>
<b>LC-007-060</b>	SHEA-BELLUCCI Scherchen, links gebogen, Schnittlänge 7mm, NL 15cm <i>SHEA-BELLUCCI scissors, curved left, cutting length 7mm, WL 15cm</i>
<b>LC-007-061</b>	SHEA-BELLUCCI Scherchen, links gebogen, Schnittlänge 7mm, NL 18cm <i>SHEA-BELLUCCI scissors, curved left, cutting length 7mm, WL 18cm</i>
<b>LC-007-062</b>	SHEA-BELLUCCI Scherchen, aufwärts gebogen, Schnittlänge 7mm, NL 8cm <i>SHEA-BELLUCCI scissors, upward curved, cutting length 7mm, WL 8cm</i>
<b>LC-007-063</b>	SHEA-BELLUCCI Scherchen, aufwärts gebogen, Schnittlänge 7mm, NL 12.5cm <i>SHEA-BELLUCCI scissors, upward curved, cutting length 7mm, WL 12.5cm</i>
<b>LC-007-064</b>	SHEA-BELLUCCI Scherchen, aufwärts gebogen, Schnittlänge 7mm, NL 15cm <i>SHEA-BELLUCCI scissors, upward curved, cutting length 7mm, WL 15cm</i>
<b>LC-007-065</b>	SHEA-BELLUCCI Scherchen, aufwärts gebogen, Schnittlänge 7mm, NL 18cm <i>SHEA-BELLUCCI scissors, upward curved, cutting length 7mm, WL 18cm</i>



**LC-007-014**  
bis / to  
**LC-007-075**



**LC-007-014**  
bis / to  
**LC-007-075**



**LC-007-100**  
bis / to  
**LD-007-112**



**LC-007-100**  
bis / to  
**LC-007-112**

Bestell-Nr. Ordering no.	Bezeichnung Description
<b>LC-007-014</b>	FISCH-BELLUCCI Mikro Scherchen, extra fein, Schnittlänge 2mm, NL 8cm <i>FISH-BELLUCCI micro scissors, extra fine, cutting length 2mm, WL 8cm</i>
<b>LC-007-014-1</b>	FISCH-BELLUCCI Mikro Scherchen, extra fein, Schnittlänge 2mm, NL 8cm, Instrument mit dünnem Schaft <i>FISH-BELLUCCI micro scissors, extra fine, cutting length 2mm, WL 8cm, instrument with slim sheath</i>
<b>LC-007-073</b>	BELLUCCI Mikro Scherchen, rechts rund gebogen, zart, NL 8cm <i>BELLUCCI micro scissors, curved right round, fine, WL 8cm</i>
<b>LC-007-074</b>	BELLUCCI Mikro Scherchen, links rund gebogen, zart, NL 8cm <i>BELLUCCI micro scissors, curved left round, fine, WL 8cm</i>
<b>LC-007-075</b>	HOUSE-BELLUCCI Mikro Scherchen, extra zart, NL 8cm <i>HOUSE-BELLUCCI micro scissors, extra fine, WL 8cm</i>
<b>LC-007-100</b>	Mikro Schere, gerade, Maulteil Ø 2.3mm, Schaft Ø 1.5mm, AL 7cm <i>Micro scissors, straight, jaw Ø 2.3mm, tube Ø 1.5mm, WL 7cm</i>
<b>LC-007-101</b>	Mikro Schere, gerade, horizontal, Maulteil Ø 2.3mm, Schaft Ø 1.5mm, AL 7cm <i>Micro scissors, straight, horizontal, jaw Ø 2.3mm, tube Ø 1.5mm, WL 7cm</i>
<b>LC-007-102</b>	Mikro Schere, aufwärts gebogen, Maulteil Ø 2.3mm, Schaft Ø 1.5mm, AL 7cm <i>Micro scissors, upward curved, jaw Ø 2.3mm, tube Ø 1.5mm, WL 7cm</i>
<b>LC-007-103</b>	Mikro Schere, horizontal aufwärts gebogen, Maulteil Ø 2.3mm, Schaft Ø 1.5mm, AL 7cm <i>Micro scissors, horizontal upward curved, jaw Ø 2.3mm, tube Ø 1.5mm, WL 7cm</i>
<b>LC-007-104</b>	Mikro Schere, recht gebogen, Maulteil Ø 2.3mm, Schaft Ø 1.5mm, AL 7cm <i>Micro scissors, curved right, jaw Ø 2.3mm, tube Ø 1.5mm, WL 7cm</i>
<b>LC-007-105</b>	Mikro Schere, links gebogen, Maulteil Ø 2.3mm, Schaft Ø 1.5mm, AL 7cm <i>Micro scissors, curved left, jaw Ø 2.3mm, tube Ø 1.5mm, WL 7cm</i>
<b>LC-007-106</b>	Mikro Schere, gerade, Maulteil Ø 2.3mm, Schnittlänge 8mm, Schaft Ø 1.5mm, AL 7cm <i>Micro scissors, straight, jaw Ø 2.3mm, cutting length 8mm, tube Ø 1.5mm, WL 7cm</i>
<b>LC-007-107</b>	Mikro Schere, fein, gerade, Maulteil Ø 1.8mm, Schaft Ø 0.9mm <i>Micro scissors, fine, straight, jaw Ø 1.8mm, tube Ø 0.9mm</i>
<b>LC-007-108</b>	Mikro Schere, fein, gerade, horizontal, Maulteil Ø 1.8mm, Schaft Ø 0.9mm <i>Micro scissors, fine, straight, horizontal, jaw Ø 1.8mm, tube Ø 0.9mm</i>
<b>LC-007-109</b>	Mikro Schere, fein, aufwärts gebogen, Maulteil Ø 1.8mm, Schaft Ø 0.9mm <i>Micro scissors, fine, upward curved, jaw Ø 1.8mm, tube Ø 0.9mm</i>
<b>LC-007-110</b>	Mikro Schere, fein, horizontal aufwärts gebogen, Maulteil Ø 1.8mm, Schaft Ø 0.9mm <i>Micro scissors, fine, horizontal upward curved, jaw Ø 1.8mm, tube Ø 0.9mm</i>
<b>LC-007-111</b>	Mikro Schere, fein, rechts gebogen, Maulteil Ø 1.8mm, Schaft Ø 0.9mm <i>Micro scissors, fine, curved right, jaw Ø 1.8mm, tube Ø 0.9mm</i>
<b>LC-007-112</b>	Mikro Schere, fein, link gebogen, Maulteil Ø 1.8mm, Schaft Ø 0.9mm <i>Micro scissors, fine, curved left, jaw Ø 1.8mm, tube Ø 0.9mm</i>



**LI-001-005**  
bis / to  
**LI-001-007**



**LI-001-010 /**  
**LI-001-018**



**LI-001-008 /**  
**LI-001-009**



**LI-001-100**  
bis / to  
**LI-001-102**



**LI-001-103**  
bis / to  
**LI-001-105**

Bestell-Nr. Ordering no.	Bezeichnung Description
<b>LI-001-005</b>	KRAUSE Ohrpolypenschnürer, 18cm KRAUSE ear polypus snare, 18cm
<b>LI-001-006</b>	Aufsatz Cannula
<b>LI-001-007</b>	Stylet Stylet
<b>LI-001-008</b>	LANGE-WILDE Ohrpolypenschnürer LANGE-WILDE ear polypus snare
<b>LI-001-009</b>	Stylet Stylet
<b>LI-001-010</b>	KRAUSE-VOSS Ohrpolypenschnürer, 18cm KRAUSE-VOSS ear polypus snare, 18cm
<b>LI-001-018</b>	Aufsatz komplett Cannula complete
<b>LI-001-100</b>	Schnürerdrähte für Ohrpolypenschnürer, geformt, 0.2mm stark, 12 Stück Snare wires for ear polyp snare, shaped, 0.2mm, 12 pieces
<b>LI-001-101</b>	Schnürerdrähte für Ohrpolypenschnürer, geformt, 0.25mm stark, 12 Stück Snare wires for ear polyp snare, shaped, 0.25mm, 12 pieces
<b>LI-001-102</b>	Schnürerdrähte für Ohrpolypenschnürer, geformt, 0.3mm stark, 12 Stück Snare wires for ear polyp snare, shaped, 0.3mm, 12 pieces
<b>LI-001-103</b>	Schnürerdrähte für Ohrpolypenschnürer, geformt, 0.2mm stark, 100 Stück Snare wires for ear polyp snare, shaped, 0.2mm, 100 pieces
<b>LI-001-104</b>	Schnürerdrähte für Ohrpolypenschnürer, geformt, 0.25mm stark, 100 Stück Snare wires for ear polyp snare, shaped, 0.25mm, 100 pieces
<b>LI-001-105</b>	Schnürerdrähte für Ohrpolypenschnürer, geformt, 0.3mm stark, 100 Stück Snare wires for ear polyp snare, shaped, 0.3mm, 100 pieces



**LD-002-105 /  
LD-002-106**



**LD-002-061 LD-002-060**  
bis / to  
**LD-002-065**



**LC-060-223 /  
LC-060-224**

**LC-060-223**  
bis / to  
**LC-060-224**

<b>Bestell-Nr. Ordering no.</b>	<b>Bezeichnung Description</b>
<b>LC-060-223</b>	HEERMANN Ohrzange, gerade, NL 10cm <i>HEERMANN ear forceps, straight, WL 10cm</i>
<b>LC-060-224</b>	HEERMANN Ohrzange, extra zart, gerade, NL 10cm <i>HEERMANN ear forceps, extra fine, straight, WL 10cm</i>
<b>LD-002-060</b>	HEERMANN Handgriff für Meißel LD-002-061 bis LD-002-065 <i>HEERMANN handle for chisels LD-002-061 to LD-002-065</i>
<b>LD-002-061</b>	HEERMANN Flachmeißel, 0.7mm <i>HEERMANN flat chisel, 0.7mm</i>
<b>LD-002-062</b>	HEERMANN Hohlmeißel, 0.7mm <i>HEERMANN hollow chisel, 0.7mm</i>
<b>LD-002-063</b>	HEERMANN Hohlmeißel, 1.0mm <i>HEERMANN hollow chisel, 1.0mm</i>
<b>LD-002-064</b>	HEERMANN Hohlmeißel, 1.5mm <i>HEERMANN hollow chisel, 1.5mm</i>
<b>LD-002-065</b>	HEERMANN Hohlmeißel, 3.0mm <i>HEERMANN hollow chisel, 3.0mm</i>
<b>LD-002-105</b>	HEERMANN Hammer, klein, 16.5cm <i>HEERMANN mallet, small, 16.5cm</i>
<b>LD-002-106</b>	HEERMANN Hammer, gross, 16.5cm <i>HEERMANN mallet, large, 16.5cm</i>



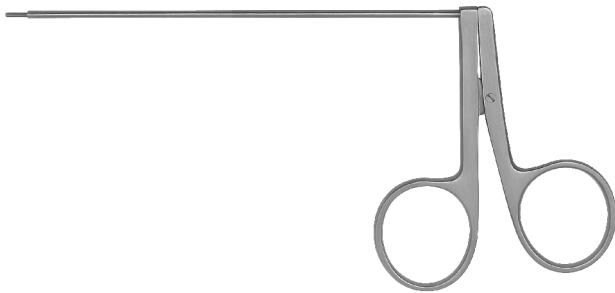

**LD-002-105 /  
 LD-002-106**



**LC-080-001  
 bis / to  
 LC-080-008**



**LC-080-010 /  
 LC-080-011**



**LC-080-020  
 bis / to  
 LC-080-024**



**LC-080-030  
 bis / to  
 LC-080-032**



**LC-080-040**

<b>Bestell-Nr. Ordering no.</b>	<b>Bezeichnung Description</b>
<b>LC-060-210</b>	Einsetzinstrument für Paukenröhrchen, klein, 0.8 x 5mm, NL 96mm <i>Myringotomy tube introducer, small, 0.8 x 5mm, WL 96</i>
<b>LC-060-211</b>	Einsetzinstrument für Paukenröhrchen, medium, 1 x 5mm, NL 96mm <i>Myringotomy tube introducer, medium, 1 x 5mm, WL 96</i>
<b>LC-080-001</b>	TÜBINGER Paukenröhrchen, Gold-Platin, Ø innen 1.25mm, Ø aussen 2.55mm, VE 10 Stück <i>TÜBINGEN myringotomy tube, gold-platinum, Ø inner 1.25mm, Ø outer 2.55mm, pack of 10 pieces</i>
<b>LC-080-002</b>	TÜBINGER Paukenröhrchen, Gold-Platin, mit Draht, Ø innen 1.25mm, Ø aussen 2.55mm, VE 10 Stück <i>TÜBINGEN myringotomy tube, gold-platinum, with wire, Ø inner 1.25mm, Ø outer 2.55mm, pack of 10 pieces</i>
<b>LC-080-003</b>	TÜBINGER Paukenröhrchen, Gold-Platin, Ø innen 1.5mm, Ø aussen 2.8mm, VE 10 Stück <i>TÜBINGEN myringotomy tube, gold-platinum, Ø inner 1.5mm, Ø outer 2.8mm, pack of 10 pieces</i>
<b>LC-080-004</b>	TÜBINGER Paukenröhrchen, Gold-Platin, mit Draht, Ø innen 1.5mm, Ø aussen 2.8mm, VE 10 Stück <i>TÜBINGEN myringotomy tube, gold-platinum, with wire, Ø inner 1.5mm, Ø outer 2.8mm, pack of 10 pieces</i>
<b>LC-080-005</b>	TÜBINGER Paukenröhrchen, Silber-vergoldet, Ø innen 1.25mm, Ø aussen 2.55mm, VE 10 Stück <i>TÜBINGEN myringotomy tube, silver-gold-plated, Ø inner 1.25mm, Ø outer 2.55mm, pack of 10 pieces</i>
<b>LC-080-006</b>	TÜBINGER Paukenröhrchen, Silber-vergoldet, mit Draht, Ø innen 1.25mm, Ø aussen 2.55mm, VE 10 Stück <i>TÜBINGEN myringotomy tube, silver-gold-plated, with wire, Ø inner 1.25mm, Ø outer 2.55mm, pack of 10 pieces</i>
<b>LC-080-007</b>	TÜBINGER Paukenröhrchen, Silber-vergoldet, Ø innen 1.5mm, Ø aussen 2.8mm, VE 10 Stück <i>TÜBINGEN myringotomy tube, silver-gold-plated, Ø inner 1.5mm, Ø outer 2.8mm, pack of 10 pieces</i>
<b>LC-080-008</b>	TÜBINGER Paukenröhrchen, Silber-vergoldet, mit Draht, Ø innen 1.5mm, Ø aussen 2.8mm, VE 10 Stück <i>TÜBINGEN myringotomy tube, silver-gold-plated, with wire, Ø inner 1.5mm, Ø outer 2.8mm, pack of 10 pieces</i>
<b>LC-080-009</b>	TÜBINGER Paukenröhrchen, titanbeschichtet, Ø innen 1.25mm, Ø aussen 2.55mm, VE 10 Stück <i>TÜBINGEN myringotomy tube, titanium coated, Ø inner 1.25mm, Ø outer 2.55mm, pack of 10 pieces</i>
<b>LC-080-012</b>	TÜBINGER Paukenröhrchen, titanbeschichtet, Ø innen 1.5mm, Ø aussen 2.8mm, VE 10 Stück <i>TÜBINGEN myringotomy tube, titanium coated, Ø inner 1.5mm, Ø outer 2.8mm, pack of 10 pieces</i>
<b>LC-080-013</b>	TÜBINGER Paukenröhrchen, Titan, Ø innen 1.25mm, Ø aussen 2.55mm, VE 10 Stück <i>TÜBINGEN myringotomy tube, titanium, Ø inner 1.25mm, Ø outer 2.55mm, pack of 10 pieces</i>
<b>LC-080-014</b>	TÜBINGER Paukenröhrchen, Titan, mit Draht, Ø innen 1.25mm, Ø aussen 2.55mm, VE 10 Stück <i>TÜBINGEN myringotomy tube, titanium, with wire, Ø inner 1.25mm, Ø outer 2.55mm, pack of 10 pieces</i>
<b>LC-080-015</b>	TÜBINGER Paukenröhrchen, Titan, Ø innen 1.5mm, Ø aussen 2.8mm, VE 10 Stück <i>TÜBINGEN myringotomy tube, titanium, Ø inner 1.5mm, Ø outer 2.8mm, pack of 10 pieces</i>
<b>LC-080-016</b>	TÜBINGER Paukenröhrchen, Titan, mit Draht, Ø innen 1.5mm, Ø aussen 2.8mm, VE 10 Stück <i>TÜBINGEN myringotomy tube, titanium, with wire, Ø inner 1.5mm, Ø outer 2.8mm, pack of 10 pieces</i>
<b>LC-080-010</b>	Paukenröhrchen, 1 Öse, Gold-Platin, Ø innen 1.5mm, Ø aussen 2.8mm, 3.8mm und 4.8mm, VE 10 Stück <i>Myringotomy tube, 1 tag, gold-platinum, Ø inner 1.5mm, Ø outer 2.8mm, 3.8mm and 4.8mm, pack of 10 pieces</i>
<b>LC-080-011</b>	Paukenröhrchen, 2 Ösen, Gold-Platin, Ø innen 1.5mm, Ø aussen 2.8mm, 3.8mm und 4.8mm, VE 10 Stück <i>Myringotomy tube, 2 tags, gold-platinum, Ø inner 1.5mm, Ø outer 2.8mm, 3.8mm and 4.8mm, pack of 10 pieces</i>
<b>LC-080-020</b>	DIABOLO Paukenröhrchen, Gold-Platin, Ø innen 0.75mm, Ø aussen 1.6mm, VE 10 Stück <i>DIABOLO myringotomy tube, gold-platinum, Ø inner 0.75mm, Ø outer 1.6mm, pack of 10 pieces</i>
<b>LC-080-021</b>	DIABOLO Paukenröhrchen, Gold-Platin, Ø innen 1.25mm, Ø aussen 2.55mm, VE 10 Stück <i>DIABOLO myringotomy tube, gold-platinum, Ø inner 1.25mm, Ø outer 2.55mm, pack of 10 pieces</i>
<b>LC-080-022</b>	DIABOLO Paukenröhrchen, Gold-Platin, Ø innen 1.5mm, Ø aussen 2.8mm, VE 10 Stück <i>DIABOLO myringotomy tube, gold-platinum, Ø inner 1.5mm, Ø outer 2.8mm, pack of 10 pieces</i>
<b>LC-080-030</b>	Paukenröhrchen, mit Trokar, Silber-vergoldet, Ø innen 1.25mm, Ø aussen 2.8mm, VE 10 Stück <i>Myringotomy tube, with trocar, silver-gold-plated, Ø inner 1.25mm, Ø outer 2.8mm, pack of 10 pieces</i>
<b>LC-080-031</b>	Paukenröhrchen, mit Trokar, Titan, Ø innen 1.25mm, Ø aussen 2.8mm, VE 10 Stück <i>Myringotomy tube, with trocar, titanium, Ø inner 1.25mm, Ø outer 2.8mm, pack of 10 pieces</i>
<b>LC-080-032</b>	Trokarhalter für LC-080-031 und LC-080-032 <i>Trocar holder for LC-080-031 and LC-080-032</i>
<b>LC-080-040</b>	BENZ Minimal-Paukenröhrchen, Edelstahl-vergoldet (nicht MRI kompatibel), Ø innen 0.6mm, VE 10 Stück <i>BENZ minimal myringotomy tube, stainless steel-gold-plated (not MRI compatible), Ø inner 0.6mm, pack of 10 pieces</i>



**LD-002-150**  
bis / to  
**LD-002-152**



**LD-002-153**

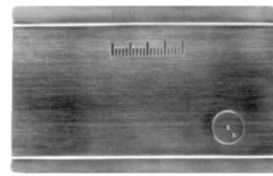

**ZA-004-265**

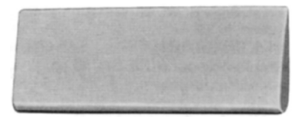

**LD-002-165**

Bestell-Nr. Ordering no.	Bezeichnung Description
<b>LD-002-150</b>	HOUSE Gelfoam-Quetschzange, Blatt 11 x 14mm, 18cm <i>HOUSE gelfoam-pressure forceps, plate 11 x 14mm, 18cm</i>
<b>LD-002-151</b>	HOUSE Gelfoam-Quetschzange, Blatt 22 x 30mm, 18cm <i>HOUSE gelfoam-pressure forceps, plate 22 x 30mm, 18cm</i>
<b>LD-002-152</b>	HOUSE Gelfoam-Quetschzange, Blatt 30 x 30mm, 18cm <i>HOUSE gelfoam-pressure forceps, plate 30 x 30mm, 18cm</i>
<b>LD-002-153</b>	SCHUHKNECHT Bieegerät <i>SCHUHKNECHT bending block</i>
<b>LD-002-154</b>	SHEA Venenpresse, 13cm (ohne Abbildung) <i>SHEA vein press, 13cm (without illustration)</i>
<b>LD-002-165</b>	ARKANSAS Abziehstein <i>ARKANSAS stone</i>
<b>ZA-004-265</b>	Präpariertablett aus Metall mit mm-Skala <i>Metal plate for measuring and preparing with mm-scale</i>

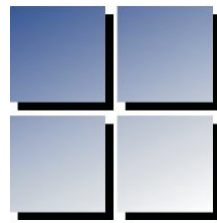

# STEMA

Medizintechnik GmbH

## RHINOLOGIE

## RHINOLOGY









**LB-010-001 /  
LF-002-010**  
bis / to  
**LF-002-013**



**LF-002-001**  
bis / to  
**LF-002-004**



**LF-002-005**  
bis / to  
**LF-002-008**



**LF-002-014**  
bis / to  
**LF-002-017**

Bestell-Nr. Ordering no.	Bezeichnung Description
<b>LB-010-001</b>	HARTMANN Nasenspekulum für Kinder, Länge 13cm, <i>HARTMANN nasal speculum for children, length 13cm</i>
<b>LF-002-001</b>	STRUYCKEN-KILLIAN Nasenspekulum, Standardmodell, AL 40mm, Länge 14cm <i>STRUYCKEN-KILLIAN nasal speculum, standard modell, WL 40mm, length 14cm</i>
<b>LF-002-002</b>	STRUYCKEN-KILLIAN Nasenspekulum, Standardmodell, AL 55mm, Länge 14cm <i>STRUYCKEN-KILLIAN nasal speculum, standard modell, WL 55mm, length 14cm</i>
<b>LF-002-003</b>	STRUYCKEN-KILLIAN Nasenspekulum, Standardmodell, AL 75mm, Länge 14cm <i>STRUYCKEN-KILLIAN nasal speculum, standard modell, WL 75mm, length 14cm</i>
<b>LF-002-004</b>	STRUYCKEN-KILLIAN Nasenspekulum, Standardmodell, AL 90mm, Länge 14cm <i>STRUYCKEN-KILLIAN nasal speculum, standard modell, WL 90mm, length 14cm</i>
<b>LF-002-005</b>	STRUYCKEN-KILLIAN Nasenspekulum, mit Feststellschraube, AL 40mm, Länge 14cm <i>STRUYCKEN-KILLIAN nasal speculum, with fixation screw, WL 40mm, length 14cm</i>
<b>LF-002-006</b>	STRUYCKEN-KILLIAN Nasenspekulum, mit Feststellschraube, AL 55mm, Länge 14cm <i>STRUYCKEN-KILLIAN nasal speculum, with fixation screw, WL 55mm, length 14cm</i>
<b>LF-002-007</b>	STRUYCKEN-KILLIAN Nasenspekulum, mit Feststellschraube, AL 75mm, Länge 14cm <i>STRUYCKEN-KILLIAN nasal speculum, with fixation screw, WL 75mm, length 14cm</i>
<b>LF-002-008</b>	STRUYCKEN-KILLIAN Nasenspekulum, mit Feststellschraube, AL 90mm, Länge 14cm <i>STRUYCKEN-KILLIAN nasal speculum, with fixation screw, WL 90mm, length 14cm</i>
<b>LF-002-010</b>	HARTMANN-HALLE Nasenspekulum, Fig. 1, AL 29mm, Länge 15.5cm <i>HARTMANN-HALLE nasal speculum, Fig. 1, WL 29mm, length 15.5cm</i>
<b>LF-002-011</b>	HARTMANN-HALLE Nasenspekulum, Fig. 2, AL 33mm, Länge 15.5cm <i>HARTMANN-HALLE nasal speculum, Fig. 2, WL 33mm, length 15.5cm</i>
<b>LF-002-012</b>	HARTMANN-HALLE Nasenspekulum, Fig. 3, AL 37mm, Länge 15.5cm <i>HARTMANN-HALLE nasal speculum, Fig. 3, WL 37mm, length 15.5cm</i>
<b>LF-002-013</b>	HARTMANN-HALLE Nasenspekulum, für Kinder, Länge 15cm <i>HARTMANN-HALLE nasal speculum, for children, length 15cm</i>
<b>LF-002-014</b>	KILLIAN Nasenspekulum, Standardmodell, AL 40mm, Länge 14cm <i>KILLIAN nasal speculum, standard modell, WL 40mm, length 14cm</i>
<b>LF-002-015</b>	KILLIAN Nasenspekulum, Standardmodell, AL 55mm, Länge 14cm <i>KILLIAN nasal speculum, standard modell, WL 55mm, length 14cm</i>
<b>LF-002-016</b>	KILLIAN Nasenspekulum, Standardmodell, AL 75mm, Länge 14cm <i>KILLIAN nasal speculum, standard modell, WL 75mm, length 14cm</i>
<b>LF-002-017</b>	KILLIAN Nasenspekulum, Standardmodell, AL 90mm, Länge 14cm <i>KILLIAN nasal speculum, standard modell, WL 90mm, length 14cm</i>



**LF-002-030**  
bis / to  
**LF-002-033**



**LF-002-018**  
bis / to  
**LF-002-020**



**LF-002-021**  
bis / to  
**LF-002-024**

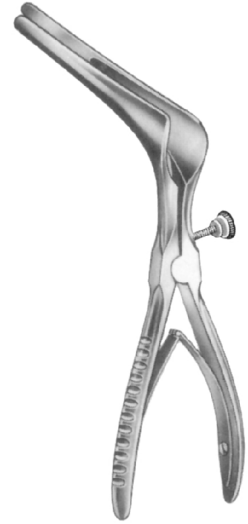

**LF-002-025**  
bis / to  
**LF-002-028**

<b>Bestell-Nr.</b> <b>Ordering no.</b>	<b>Bezeichnung</b> <b>Description</b>
<b>LF-002-018</b>	WALTER Nasenspekulum, extra dünnes Blatt, mit Feststellschraube, AL 35mm, Länge 13cm <i>WALTER nasal speculum, extra thin valve, with fixation screw, WL 35mm, length 13cm</i>
<b>LF-002-019</b>	WALTER Nasenspekulum, extra dünnes Blatt, mit Feststellschraube, AL 55mm, Länge 13cm <i>WALTER nasal speculum, extra thin valve, with fixation screw, WL 55mm, length 13cm</i>
<b>LF-002-020</b>	WALTER Nasenspekulum, extra dünnes Blatt, mit Feststellschraube, AL 75mm, Länge 13cm <i>WALTER nasal speculum, extra thin valve, with fixation screw, WL 75mm, length 13cm</i>
<b>LF-002-021</b>	COTTLE Nasenspekulum, AL 35mm, Länge 13cm <i>COTTLE nasal speculum, WL 35mm, length 13cm</i>
<b>LF-002-022</b>	COTTLE Nasenspekulum, AL 55mm, Länge 13cm <i>COTTLE nasal speculum, WL 55mm, length 13cm</i>
<b>LF-002-023</b>	COTTLE Nasenspekulum, AL 75mm, Länge 13cm <i>COTTLE nasal speculum, WL 75mm, length 13cm</i>
<b>LF-002-024</b>	COTTLE Nasenspekulum, AL 90mm, Länge 13cm <i>COTTLE nasal speculum, WL 90mm, length 13cm</i>
<b>LF-002-025</b>	COTTLE Nasenspekulum, mit Feststellschraube, AL 35mm, Länge 13cm <i>COTTLE nasal speculum, with fixation screw, WL 35mm, length 13cm</i>
<b>LF-002-026</b>	COTTLE Nasenspekulum, mit Feststellschraube, AL 55mm, Länge 13cm <i>COTTLE nasal speculum, with fixation screw, WL 55mm, length 13cm</i>
<b>LF-002-027</b>	COTTLE Nasenspekulum, mit Feststellschraube, AL 75mm, Länge 13cm <i>COTTLE nasal speculum, with fixation screw, WL 75mm, length 13cm</i>
<b>LF-002-028</b>	COTTLE Nasenspekulum, mit Feststellschraube, AL 90mm, Länge 13cm <i>COTTLE nasal speculum, with fixation screw, WL 90mm, length 13cm</i>
<b>LF-002-030</b>	KILLIAN-WALTER Nasenspekulum, extra dünnes Blatt, mit Feststellschraube, AL 40mm, Länge 14cm <i>KILLIAN-WALTER nasal speculum, extra thin valve, with fixation screw, WL 40mm, length 14cm</i>
<b>LF-002-031</b>	KILLIAN-WALTER Nasenspekulum, extra dünnes Blatt, mit Feststellschraube, AL 55mm, Länge 14cm <i>KILLIAN-WALTER nasal speculum, extra thin valve, with fixation screw, WL 55mm, length 14cm</i>
<b>LF-002-032</b>	KILLIAN-WALTER Nasenspekulum, extra dünnes Blatt, mit Feststellschraube, AL 75mm, Länge 14cm <i>KILLIAN-WALTER nasal speculum, extra thin valve, with fixation screw, WL 75mm, length 14cm</i>
<b>LF-002-033</b>	KILLIAN-WALTER Nasenspekulum, extra dünnes Blatt, mit Feststellschraube, AL 90mm, Länge 14cm <i>KILLIAN-WALTER nasal speculum, extra thin valve, with fixation screw, WL 90mm, length 14cm</i>



**LF-002-034**  
bis / to  
**LF-002-037**



**LF-002-039**  
bis / to  
**LF-002-041**



**LF-002-042**  
bis / to  
**LF-002-045**



**LF-002-046**  
bis / to  
**LF-002-049**



**LF-002-060 /**  
**LF-002-061**

Bestell-Nr. Ordering no.	Bezeichnung Description
<b>LF-002-034</b>	KILLIAN Nasenspekulum, Standardmodell, mit Feststellschraube, AL 40mm, Länge 14cm <i>KILLIAN nasal speculum, standard modell, with fixation screw, WL 40mm, length 14cm</i>
<b>LF-002-035</b>	KILLIAN Nasenspekulum, Standardmodell, mit Feststellschraube, AL 55mm, Länge 14cm <i>KILLIAN nasal speculum, standard modell, with fixation screw, WL 55mm, length 14cm</i>
<b>LF-002-036</b>	KILLIAN Nasenspekulum, Standardmodell, mit Feststellschraube, AL 75mm, Länge 14cm <i>KILLIAN nasal speculum, standard modell, with fixation screw, WL 75mm, length 14cm</i>
<b>LF-002-037</b>	KILLIAN Nasenspekulum, Standardmodell, mit Feststellschraube, AL 90mm, Länge 14cm <i>KILLIAN nasal speculum, standard modell, with fixation screw, WL 90mm, length 14cm</i>
<b>LF-002-039</b>	WIENER Nasenspekulum, Baby, Fig. 1 <i>WIENER nasal speculum, baby, fig. 1</i>
<b>LF-002-040</b>	WIENER Nasenspekulum, Kinder, Fig. 2 <i>WIENER nasal speculum, children, fig. 2</i>
<b>LF-002-041</b>	WIENER Nasenspekulum, Erwachsene, Fig. 3 <i>WIENER nasal speculum, adults, fig. 3</i>
<b>LF-002-042</b>	KILLIAN Nasenspekulum, mit Zähnen links, mit Feststellschraube, für flexiblen Spannarm, AL 40mm/55mm, Länge 14cm <i>KILLIAN nasal speculum, serrated left, with fixation screw, used for flexible arm, WL 40mm/55mm, length 14cm</i>
<b>LF-002-043</b>	KILLIAN Nasenspekulum, mit Zähnen rechts, mit Feststellschraube, für flexiblen Spannarm, AL 40mm/55mm, Länge 14cm <i>KILLIAN nasal speculum, serrated right, with fixation screw, used for flexible arm, WL 40mm/55mm, length 14cm</i>
<b>LF-002-044</b>	KILLIAN Nasenspekulum, mit Zähnen links, mit Feststellschraube, für flexiblen Spannarm, AL 40mm/75mm, Länge 14cm <i>KILLIAN nasal speculum, serrated left, with fixation screw, used for flexible arm, WL 40mm/75mm, length 14cm</i>
<b>LF-002-045</b>	KILLIAN Nasenspekulum, mit Zähnen rechts, mit Feststellschraube, für flexiblen Spannarm, AL 40mm/75mm, Länge 14cm <i>KILLIAN nasal speculum, serrated right, with fixation screw, used for flexible arm, WL 40mm/75mm, length 14cm</i>
<b>LF-002-046</b>	KILLIAN Nasenspekulum, mit Feststellschraube, für flexiblen Spannarm, AL 40mm, Länge 14cm <i>KILLIAN nasal speculum, with fixation screw, used for flexible arm, WL 40mm, length 14cm</i>
<b>LF-002-047</b>	KILLIAN Nasenspekulum, mit Feststellschraube, für flexiblen Spannarm, AL 55mm, Länge 14cm <i>KILLIAN nasal speculum, with fixation screw, used for flexible arm, WL 55mm, length 14cm</i>
<b>LF-002-048</b>	KILLIAN Nasenspekulum, mit Feststellschraube, für flexiblen Spannarm, AL 75mm, Länge 14cm <i>KILLIAN nasal speculum, with fixation screw, used for flexible arm, WL 75mm, length 14cm</i>
<b>LF-002-049</b>	KILLIAN Nasenspekulum, mit Feststellschraube, für flexiblen Spannarm, AL 90mm, Länge 14cm <i>KILLIAN nasal speculum, with fixation screw, used for flexible arm, WL 90mm, length 14cm</i>
<b>LF-002-060</b>	HALLE-TIECK Nasenspekulum, Kleinkinder, Länge 13cm <i>HALLE-TIECK nasal speculum, babies, length 13cm</i>
<b>LF-002-061</b>	HALLE-TIECK Nasenspekulum, Kinder, Länge 13cm <i>HALLE-TIECK nasal speculum, children, length 13cm</i>





**LF-002-095**  
bis / to  
**LF-002-097**



**LF-002-070**  
bis / to  
**LF-002-072**



**LF-002-090**  
bis / to  
**LF-002-093**



**LF-002-080 /**  
**LF-002-081**

<b>Bestell-Nr.</b> <b>Ordering no.</b>	<b>Bezeichnung</b> <b>Description</b>
<b>LF-002-070</b>	HARTMANN Nasenspekulum, Kinder, Fig. 1, Länge 15cm <i>HARTMANN nasal speculum, children, fig. 1, length 15cm</i>
<b>LF-002-071</b>	HARTMANN Nasenspekulum, Fig. 2, Länge 15cm <i>HARTMANN nasal speculum, fig. 2, length 15cm</i>
<b>LF-002-072</b>	HARTMANN Nasenspekulum, Fig. 3, Länge 15cm <i>HARTMANN nasal speculum, fig. 3, length 15cm</i>
<b>LF-002-080</b>	STRUYCKEN-KILLIAN Nasenspekulum, linkes Blatt 75mm, rechtes Blatt 45mm, Länge 14cm <i>STRUYCKEN-KILLIAN nasal speculum, left blade 75mm, right blade 45mm, length 14cm</i>
<b>LF-002-081</b>	STRUYCKEN-KILLIAN Nasenspekulum, linkes Blatt 45mm, rechtes Blatt 75mm, Länge 14cm <i>STRUYCKEN-KILLIAN nasal speculum, left blade 45mm, right blade 75mm, length 14cm</i>
<b>LF-002-090</b>	BECKMANN Nasenspekulum, Säuglinge, Länge 13cm <i>BECKMANN nasal speculum, babies, length 13cm</i>
<b>LF-002-091</b>	BECKMANN Nasenspekulum, Fig. 1, Länge 15cm <i>BECKMANN nasal speculum, fig. 1, length 15cm</i>
<b>LF-002-092</b>	BECKMANN Nasenspekulum, Fig. 2, Länge 15cm <i>BECKMANN nasal speculum, fig. 2, length 15cm</i>
<b>LF-002-093</b>	BECKMANN Nasenspekulum, Fig. 3, Länge 15cm <i>BECKMANN nasal speculum, fig. 3, length 15cm</i>
<b>LF-002-095</b>	HARTMANN-HALLE Nasenspekulum, Schraubverschluss, Fig. 1, AL 29mm, Länge 15.5cm <i>HARTMANN-HALLE nasal speculum, screw plug, fig. 1, WL 29mm, length 15.5cm</i>
<b>LF-002-096</b>	HARTMANN-HALLE Nasenspekulum, Schraubverschluss, Fig. 2, AL 33mm, Länge 15.5cm <i>HARTMANN-HALLE nasal speculum, screw plug, fig. 2, WL 33mm, length 15.5cm</i>
<b>LF-002-097</b>	HARTMANN-HALLE Nasenspekulum, Schraubverschluss, Fig. 3, AL 37mm, Länge 15.5cm <i>HARTMANN-HALLE nasal speculum, screw plug, fig. 3, WL 37mm, length 15.5cm</i>



**LF-002-082 /  
LF-002-083**

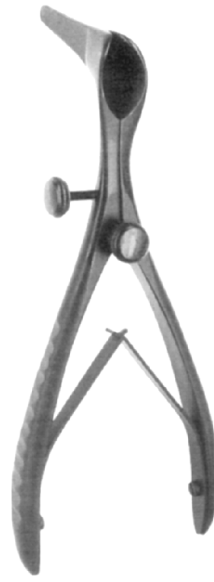

**LF-002-084  
bis / to  
LF-002-087**



**LF-002-050  
bis / to  
LF-002-056**

<b>Bestell-Nr. Ordering no.</b>	<b>Bezeichnung Description</b>
<b>LF-002-050</b>	THUDICHUM Nasenspekulum, Fig. 1, Länge 6.5cm <i>THUDICHUM nasal speculum, fig. 1, length 6.5cm</i>
<b>LF-002-051</b>	THUDICHUM Nasenspekulum, Fig. 2, Länge 6.5cm <i>THUDICHUM nasal speculum, fig. 2, length 6.5cm</i>
<b>LF-002-052</b>	THUDICHUM Nasenspekulum, Fig. 3, Länge 6.5cm <i>THUDICHUM nasal speculum, fig. 3, length 6.5cm</i>
<b>LF-002-053</b>	THUDICHUM Nasenspekulum, Fig. 4, Länge 6.5cm <i>THUDICHUM nasal speculum, fig. 4, length 6.5cm</i>
<b>LF-002-054</b>	THUDICHUM Nasenspekulum, Fig. 5, Länge 6.5cm <i>THUDICHUM nasal speculum, fig. 5, length 6.5cm</i>
<b>LF-002-055</b>	THUDICHUM Nasenspekulum, Fig. 6, Länge 6.5cm <i>THUDICHUM nasal speculum, fig. 6, length 6.5cm</i>
<b>LF-002-056</b>	THUDICHUM Nasenspekulum, Fig. 7, Länge 6.5cm <i>THUDICHUM nasal speculum, fig. 7, length 6.5cm</i>
<b>LF-002-082</b>	COTTLE Nasenspekulum, mit Absaugrohr links, ohne Stellschraube, AL 35mm, Länge 13cm <i>COTTLE nasal speculum, with suction tube left, without fixation screw, WL 35mm, length 13cm</i>
<b>LF-002-083</b>	COTTLE Nasenspekulum, mit Absaugrohr rechts, ohne Stellschraube, AL 35mm, Länge 13cm <i>COTTLE nasal speculum, with suction tube right, without fixation screw, WL 35mm, length 13cm</i>
<b>LF-002-084</b>	COTTLE Nasenspekulum, schwarz, dünne Blätter, mit Stellschraube, AL 35mm, Länge 13cm <i>COTTLE nasal speculum, black, very delicate blades, with fixation screw, WL 35mm, length 13cm</i>
<b>LF-002-085</b>	COTTLE Nasenspekulum, schwarz, dünne Blätter, mit Stellschraube, AL 45mm, Länge 13cm <i>COTTLE nasal speculum, black, very delicate blades, with fixation screw, WL 45mm, length 13cm</i>
<b>LF-002-086</b>	COTTLE Nasenspekulum, schwarz, dünne Blätter, mit Stellschraube, AL 55mm, Länge 13cm <i>COTTLE nasal speculum, black, very delicate blades, with fixation screw, WL 55mm, length 13cm</i>
<b>LF-002-087</b>	COTTLE Nasenspekulum, schwarz, dünne Blätter, mit Stellschraube, AL 70mm, Länge 13cm <i>COTTLE nasal speculum, black, very delicate blades, with fixation screw, WL 70mm, length 13cm</i>



**LL-001-001**



**LL-001-002**



**ZA-004-362**



**ZA-004-363**

<b>Bestell-Nr.</b> <b>Ordering no.</b>	<b>Bezeichnung</b> <b>Description</b>
<b>LL-001-001</b>	Flexibler Spannarm, komplett mit Haltestange zur Befestigung an OP-Tischschiene <i>Flexible tension arm, complete with holding rod for attachment to operating table</i>
<b>LL-001-002</b>	Spannkolben für Spannarm <i>Rotation clamp for tension arm</i>
<b>ZA-004-362</b>	AUFRICHT Haken für flexiblen Spannarm <i>AUFRICHT retractor for flexible tension arm</i>
<b>ZA-004-363</b>	AUFRICHT Haken, 2-zinkig, für flexiblen Spannarm <i>AUFRICHT retractor, 2-prongs, for flexible tension arm</i>



**LJ-003-001**  
bis / to  
**LJ-003-003**



**LJ-003-020**  
bis / to  
**LJ-003-023**

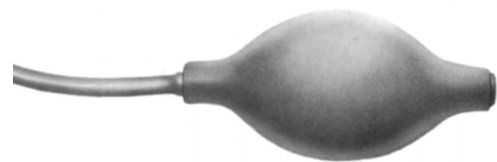

**LJ-003-024**

Bestell-Nr. Ordering no.	Bezeichnung Description
<b>LJ-003-001</b>	Universal Zerstäuber mit beweglicher Düse, Schraubflasche 30ccm und Halbgebläse <i>Universal atomizer with movable nozzle, threaded bottle 30ccm and rubber bulb</i>
<b>LJ-003-002</b>	Universal Zerstäuber mit beweglicher Düse, Schraubflasche 30ccm <i>Universal atomizer with movable nozzle, threaded bottle 30ccm</i>
<b>LJ-003-003</b>	Halbgebläse allein <i>Rubber bulb only</i>
<b>LJ-003-020</b>	GRÜNWALD Zerstäuber, komplett mit 3 Zerstäuber, Ständer, ohne Halbgebläse <i>GRÜNWALD atomizer, complete with 3 atomizer, rack, without rubber bulb</i>
<b>LJ-003-021</b>	GRÜNWALD Zerstäuber, gerade Kanüle <i>GRÜNWALD atomizer, straight cannula</i>
<b>LJ-003-022</b>	GRÜNWALD Zerstäuber, abgebogene Kanüle <i>GRÜNWALD atomizer, tube downward</i>
<b>LJ-003-023</b>	GRÜNWALD Zerstäuber, aufgebogene Kanüle <i>GRÜNWALD atomizer, tube upward</i>
<b>LJ-003-024</b>	Halbgebläse für GRÜNWALD Zerstäuber <i>Rubber bulb for GRÜNWALD atomizer</i>
<b>LJ-003-025</b>	Ersatzglas (ohne Abbildung) <i>Spare bottle (without illustration)</i>



**LD-001-116**



**LD-005-007 /  
LD-005-018**



**LD-005-019 /  
LD-005-024 /  
LD-005-025**



**LK-001-001  
bis / to  
LK-001-003**



**LK-001-004  
bis / to  
LK-001-006**

<b>Bestell-Nr. Ordering no.</b>	<b>Bezeichnung Description</b>
<b>LD-001-116</b>	LANGE Choanenhaken, 22cm LANGE choana hook, 22cm
<b>LD-005-007</b>	Watteträger, gerieft, Ø 1.2mm, 16cm Cotton applicator, serrated, Ø 1.2mm, 16cm
<b>LD-005-018</b>	Watteträger, gerieft, Ø 1.5mm, 18cm Cotton applicator, serrated, Ø 1.5mm, 18cm
<b>LD-005-019</b>	Watteträger, dreikant gerieft, Ø 1.2mm, 18cm Cotton applicator, triangular serrated, Ø 1.2mm, 18cm
<b>LD-005-024</b>	Watteträger, dreikant gerieft, Ø 1.5mm, 16cm Cotton applicator, triangular serrated, Ø 1.5mm, 16cm
<b>LD-005-025</b>	Watteträger, dreikant gerieft, Ø 1.5mm, 16cm Cotton applicator, triangular serrated, Ø 1.5mm, 16cm
<b>LK-001-001</b>	LOGAN Lippensperrer, je 3 scharfe Zähne, klein (29mm), Mindestbestellmenge 20 Stück LOGAN lip traction bow, 3 sharp teeth, small (29mm), minimum order quantity 20 pieces
<b>LK-001-002</b>	LOGAN Lippensperrer, je 3 scharfe Zähne, medium (32mm), Mindestbestellmenge 20 Stück LOGAN lip traction bow, 3 sharp teeth, medium (32mm), minimum order quantity 20 pieces
<b>LK-001-003</b>	LOGAN Lippensperrer, je 3 scharfe Zähne, gross (35mm), Mindestbestellmenge 20 Stück LOGAN lip traction bow, 3 sharp teeth, large (35mm), minimum order quantity 20 pieces
<b>LK-001-004</b>	LOGAN Lippensperrer, ohne Zähne, klein (29mm), Mindestbestellmenge 20 Stück LOGAN lip traction bow, without teeth, small (29mm), minimum order quantity 20 pieces
<b>LK-001-005</b>	LOGAN Lippensperrer, ohne Zähne, medium (32mm), Mindestbestellmenge 20 Stück LOGAN lip traction bow, without teeth, medium (32mm), minimum order quantity 20 pieces
<b>LK-001-006</b>	LOGAN Lippensperrer, ohne Zähne, gross (35mm), Mindestbestellmenge 20 Stück LOGAN lip traction bow, without teeth, large (35mm), minimum order quantity 20 pieces

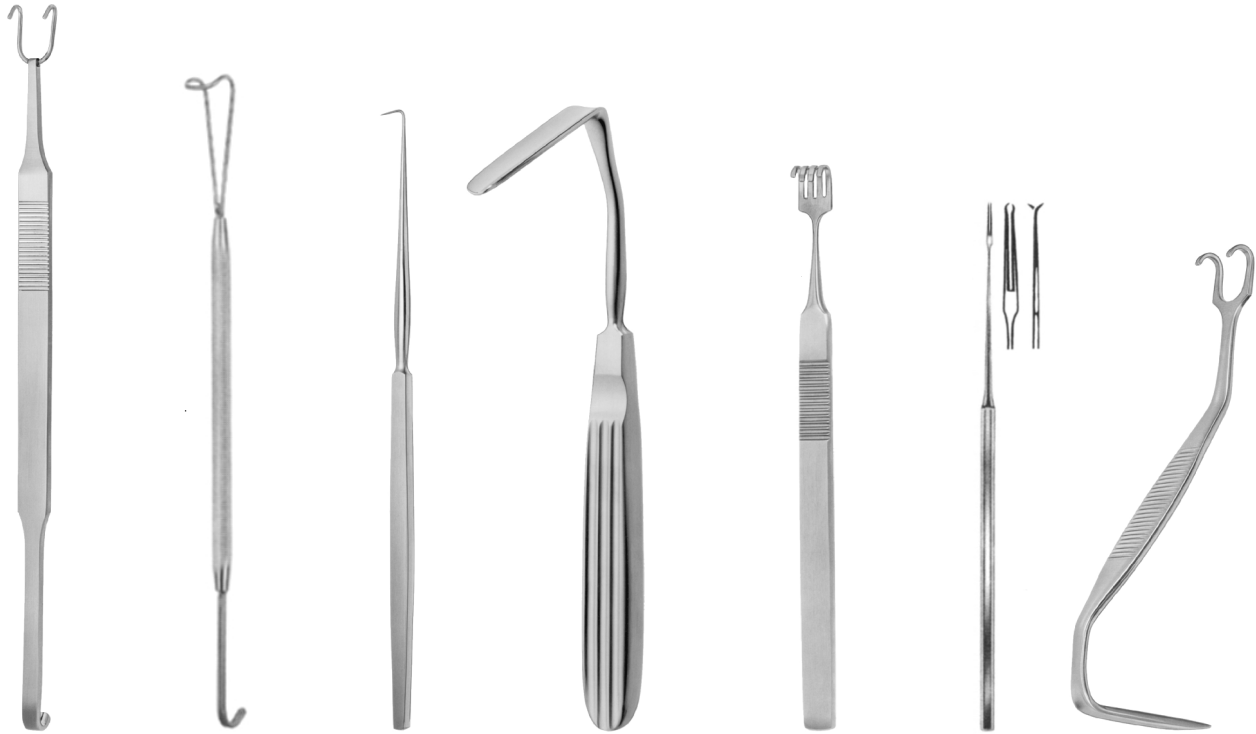

LD-001-105 /  
LD-001-106

LD-001-107

LD-001-100

LD-001-109 /  
LD-001-110

LD-001-104

LD-001-103

LD-001-108

Bestell-Nr. Ordering no.	Bezeichnung Description
LD-001-100	COTTLE Nasenhaken, 17cm <i>COTTLE nasal hook, 17cm</i>
LD-001-103	TWIST Hauthäkchen, 14cm <i>TWIST skin hook, 14cm</i>
LD-001-104	COTTLE Nasenhaken, stumpf, 4-zahnig, 15cm <i>COTTLE nasal hook, blunt, 4 prongs, 15cm</i>
LD-001-105	COTTLE-NEIVERT Doppelhaken, großes USA Modell, 22cm <i>COTTLE-NEIVERT knife guide and retractor, large USA model, 22cm</i>
LD-001-106	COTTLE-NEIVERT Doppelhaken, kleines USA Modell, 22cm <i>COTTLE-NEIVERT knife guide and retractor, small USA model, 22cm</i>
LD-001-107	NEIVERT Doppelhaken aus Draht, 20cm <i>NEIVERT knife guide and retractor, wire shape, 20cm</i>
LD-001-108	WALTER Doppelinstrument, Nasenflügel/Nasenrückenhaken, 12.5cm <i>WALTER nasal retractor, double ended, 12.5cm</i>
LD-001-109	AUFRICHT Nasenrückenhaken, 60mm Blattlänge, 17cm <i>AUFRICHT nasal retractor, 60mm blade length, 17cm</i>
LD-001-110	AUFRICHT Nasenrückenhaken, 45mm Blattlänge, 17cm <i>AUFRICHT nasal retractor, 45mm blade length, 17cm</i>



LD-001-174



LD-001-173



LD-001-112



LD-001-113  
bis / to  
LD-001-115



LD-001-111

Bestell-Nr. Ordering no.	Bezeichnung Description
LD-001-111	COTTLE (MILLARD) Fingerringhäkchen, 2-zahnig, scharf, 5.5cm <i>COTTLE (MILLARD) thimble hook, 2 prongs, sharp, 5.5cm</i>
LD-001-112	CONVERSE Nasenflügel Doppelhaken, 2-zahnig, stumpf-stumpf, 12cm <i>CONVERSE alar hook, double ended, blunt/blunt, 12cm</i>
LD-001-113	KILNER Nasenflügelretractor, scharf, 2-zahnig, 10mm breit, 8.5cm <i>KILNER alar retractor, sharp, 2 prongs, 10mm wide, 8.5cm</i>
LD-001-114	KILNER Nasenflügelretractor, stumpf, 2-zahnig, 10mm breit, 8.5cm <i>KILNER alar retractor, blunt, 2 prongs, 10mm wide, 8.5cm</i>
LD-001-115	KILNER Nasenflügelretractor, scharf, 2-zahnig, 13mm breit, 8.5cm <i>KILNER alar retractor, sharp, 2 prongs, 13mm wide, 8.5cm</i>
LD-001-117	Nasenhaken, große Biegung, 16.5cm (ohne Abbildung) <i>Nasal hook, strong curved, 16.5cm (without illustration)</i>
LD-001-118	SENN Doppelhaken, stumpf, 15cm (ohne Abbildung) <i>SENN double hook, blunt, 15cm (without illustration)</i>
LD-001-173	CLOWARD Durahäkchen, 16cm <i>CLOWARD dura hook, 16cm</i>
LD-001-174	FOMON Häkchen, stumpf, 1-zahnig, 17cm <i>FOMON hook, blunt, 1 prong, 17cm</i>



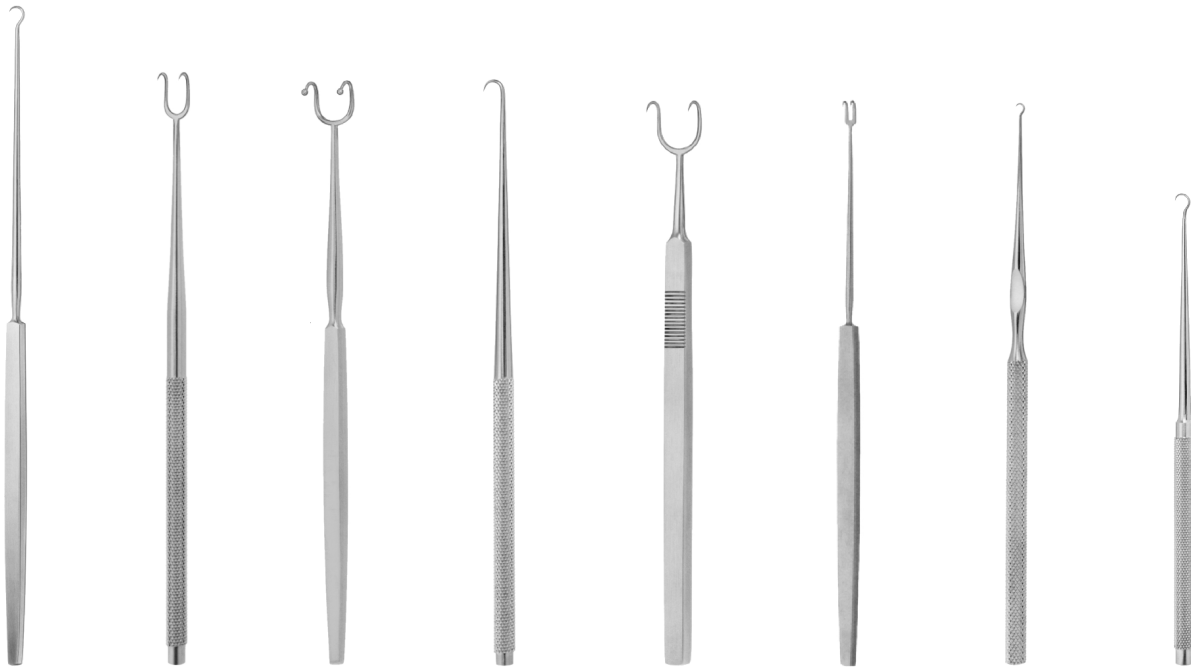

**LD-003-063 /  
LD-003-064**

**LD-003-150  
bis / to  
LD-003-153**

**LD-003-154**

**LD-003-155  
bis / to  
LD-003-157**

**LD-003-050**

**LD-003-062**

**LD-003-068**

**LD-003-065  
bis / to  
LD-003-067**

<b>Bestell-Nr. Ordering no.</b>	<b>Bezeichnung Description</b>
<b>LD-003-050</b>	COTTLE Häkchen, scharf, 2-zahnig, 15cm <i>COTTLE hook, sharp, 2 prongs, 15cm</i>
<b>LD-003-062</b>	FREER Häkchen, scharf, 2-zahnig, 15cm <i>FREER hook, sharp, 2 prongs, 15cm</i>
<b>LD-003-063</b>	GILLIES Hauthaken, klein, 19cm <i>GILLIES skin hook, small, 19cm</i>
<b>LD-003-064</b>	GILLIES Hauthaken, groß, 19cm <i>GILLIES skin hook, large, 19cm</i>
<b>LD-003-065</b>	KLEINERT-KUTZ Hauthaken, klein, 13cm <i>KLEINERT-KUTZ skin hook, small, 13cm</i>
<b>LD-003-066</b>	KLEINERT-KUTZ Hauthaken, mittel, 13cm <i>KLEINERT-KUTZ skin hook, medium, 13cm</i>
<b>LD-003-067</b>	KLEINERT-KUTZ Hauthaken, groß, 13cm <i>KLEINERT-KUTZ skin hook, large, 13cm</i>
<b>LD-003-068</b>	KILNER Hauthaken, scharf, 15cm <i>KILNER skin hook, sharp, 15cm</i>
<b>LD-003-150</b>	JOSEPH Doppelhäkchen, scharf, 2mm breit, 16cm <i>JOSEPH double hook, sharp, 2mm wide, 16cm</i>
<b>LD-003-151</b>	JOSEPH Doppelhäkchen, scharf, 5mm breit, 16cm <i>JOSEPH double hook, sharp, 5mm wide, 16cm</i>
<b>LD-003-152</b>	JOSEPH Doppelhäkchen, scharf, 7mm breit, 16cm <i>JOSEPH double hook, sharp, 7mm wide, 16cm</i>
<b>LD-003-153</b>	JOSEPH Doppelhäkchen, scharf, 10mm breit, 16cm <i>JOSEPH double hook, sharp, 10mm wide, 16cm</i>
<b>LD-003-154</b>	FOMON Nasenflügelhaken, geknöpft, 2-zahnig, 10mm breit, 16cm <i>FOMON nasal hook, blunt, 2 prongs, 10mm wide, 16cm</i>
<b>LD-003-155</b>	COTTLE Nasenhäkchen, Fig. 1, 16cm <i>COTTLE nasal hook, fig. 1, 16cm</i>
<b>LD-003-156</b>	COTTLE Nasenhäkchen, Fig. 2, 16cm <i>COTTLE nasal hook, fig. 2, 16cm</i>
<b>LD-003-157</b>	COTTLE Nasenhäkchen, Fig. 3, 16cm <i>COTTLE nasal hook, fig. 3, 16cm</i>

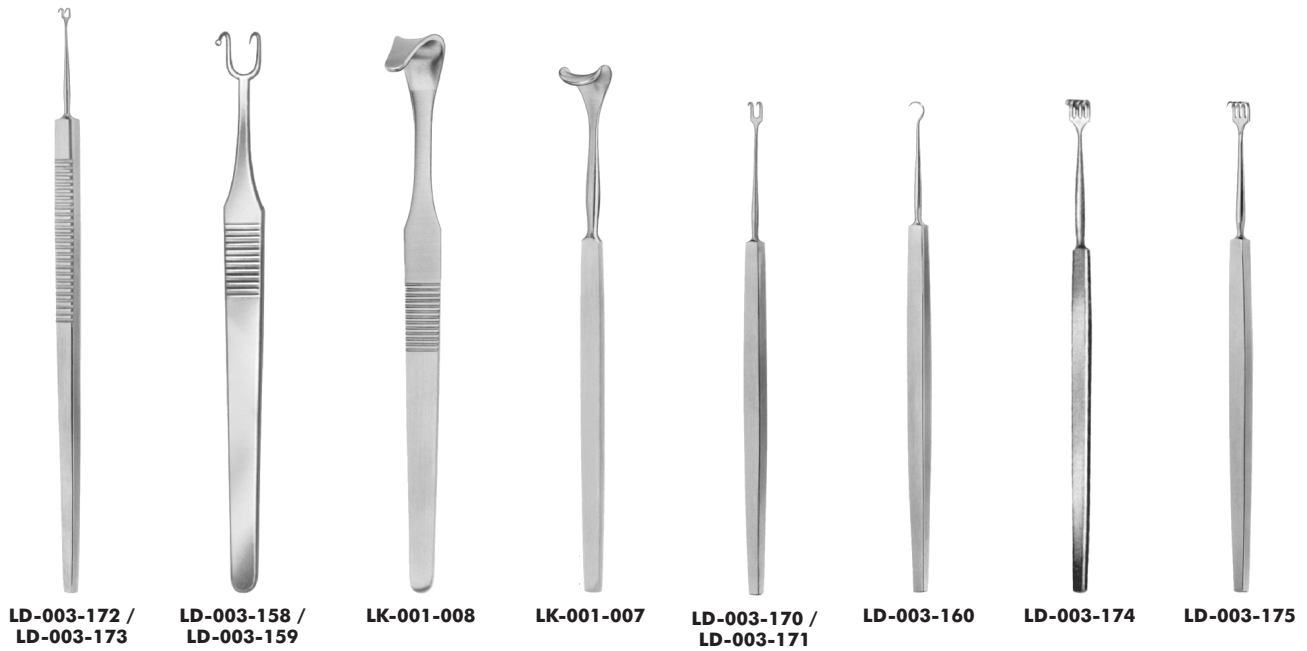

Bestell-Nr. Ordering no.	Bezeichnung Description
LD-003-158	COTTLE Nasenhäkchen, 2-zahnig, rechts geknöpft, links scharf, 10mm breit, 15cm COTTLE nasal hook, 2 prongs, right blunt, left sharp, 10mm wide, 15cm
LD-003-159	COTTLE Nasenhäkchen, 2-zahnig, rechts scharf, links geknöpft, 10mm breit, 15cm COTTLE nasal hook, 2 prongs, right sharp, left blunt, 10mm wide, 15cm
LD-003-160	FRAZIER Häkchen, spitz, 1-zahnig, 13cm FRAZIER hook, sharp, 1 prong, 13cm
LD-003-170	GUTHRIE Häkchen, klein, 2-zahnig, 12.5cm GUTHRIE skin hook, small, 2 prongs, 12.5cm
LD-003-171	GUTHRIE Häkchen, groß, 2-zahnig, 13cm GUTHRIE skin hook, large, 2 prongs, 13cm
LD-003-172	GUTHRIE Häkchen, klein, 2-zahnig, Griff geriffelt, 16cm GUTHRIE skin hook, small, 2 prongs, riffled handle, 16cm
LD-003-173	GUTHRIE Häkchen, gross, 2-zahnig, Griff geriffelt, 16cm GUTHRIE skin hook, largel, 2 prongs, riffled handle, 16cm
LD-003-174	KNAPP Wundhaken, stumpf, 4-zahnig, 13cm KNAPP wound retractor, blunt, 4 prongs, 13cm
LD-003-175	ROLLET Wundhaken, scharf, 4-zahnig, 13cm ROLLET wound retractor, sharp, 4 prongs, 13cm
LK-001-007	COTTLE Nasenflügelhalter, kurzer Blatt, 14cm COTTLE alar retractor, short blade, 14cm
LK-001-008	COTTLE Nasenflügelhalter, mit Lippe, 15cm COTTLE alar retractor, with lip, 15cm



**LD-001-206**  
bis / to  
**LD-001-214**



**LK-010-001**

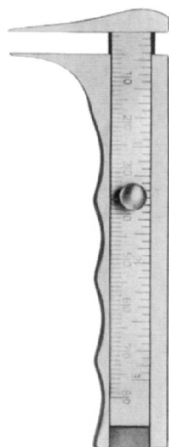

**LK-010-002**



**ZA-004-264**



**ZA-004-266**

Bestell-Nr. Ordering no.	Bezeichnung Description
<b>LD-001-206</b>	YANKAUER Septumnadel, leicht gebogen, vorwärts, 17cm YANKAUER septum needle, slightly curved, forward, 17cm
<b>LD-001-207</b>	YANKAUER Septumnadel, stark gebogen, rückwärts, 17cm YANKAUER septum needle, strong curved, backwards, 17cm
<b>LD-001-208</b>	YANKAUER Septumnadel, nach rechts gebogen, 17cm YANKAUER septum needle, curved right, 17cm
<b>LD-001-209</b>	YANKAUER Septumnadel, nach links gebogen, 17cm YANKAUER septum needle, curved left, 17cm
<b>LD-001-210</b>	YANKAUER Septumnadel, nach unten gebogen, 17cm YANKAUER septum needle, curved downwards, 17cm
<b>LD-001-211</b>	YANKAUER Septumnadel, nach links gebogen, 17cm YANKAUER septum needle, curved left, 17cm
<b>LD-001-212</b>	YANKAUER Septumnadel, nach rechts gebogen, 17cm YANKAUER septum needle, curved right, 17cm
<b>LD-001-213</b>	YANKAUER Septumnadel, 90° nach links gebogen, 17cm YANKAUER septum needle, 90° curved left, 17cm
<b>LD-001-214</b>	YANKAUER Septumnadel, leicht nach unten gebogen, 17cm YANKAUER septum needle, slightly curved downwards, 17cm
<b>LK-010-001</b>	JOSEPH Meßstab, "mm" und "cm", 17cm JOSEPH measuring instrument, "mm" and "cm", 17cm
<b>LK-010-002</b>	JAMESON Profilometer, "cm" und "Zoll" JAMESON caliper, "cm" and "inch"
<b>ZA-004-264</b>	CASTROVIEJO Zirkel, 20mm Skala, 7cm CASTROVIEJO caliper, 20mm scale, 7cm
<b>ZA-004-266</b>	Metall Messstab, flexibel, 20cm Measuring rule, metal, flexible, 20cm



LD-003-226



LD-003-230  
bis / to  
LD-003-232



LD-003-233  
bis / to  
LD-003-238



LD-003-225



LD-003-227



LD-003-228



LD-003-229

Bestell-Nr. Ordering no.	Bezeichnung Description
LD-003-225	FREER Mucosamesser, 15cm <i>FREER mucosa knife, 15cm</i>
LD-003-226	FREER Septummesser, abgebogen, 19cm <i>FREER septum knife, angled, 19cm</i>
LD-003-227	COTTLE Septummesser, gerade, 15cm <i>COTTLE septum knife, straight, 15cm</i>
LD-003-228	MASING Ritzmesser, leicht gebogen, mit Platte, 15cm <i>MASING septum knife, slightly curved, with plate, 15cm</i>
LD-003-229	MASING Ritzmesser, leicht gebogen, 15cm <i>MASING septum knife, slightly curved, 15cm</i>
LD-003-230	BRÜNING'S Septummesser, 16.5cm <i>BRÜNING'S septum knife, 16.5cm</i>
LD-003-231	Ersatzklinge für BRÜNING'S Septummesser, 16.5cm <i>Spare blade BRÜNING'S septum knife, 16.5cm</i>
LD-003-232	Griff für BRÜNING'S Septummesser, 16.5cm <i>Handle BRÜNING'S septum knife, 16.5cm</i>
LD-003-233	JOSEPH Messer mit Knopf, 15cm <i>JOSEPH knife with button, 15cm</i>
LD-003-234	JOSEPH Messer mit Knopf, gebogen, 15cm <i>JOSEPH knife with button, curved, 15cm</i>
LD-003-235	JOSEPH Messer spitz, gerade, schmal, 16cm <i>JOSEPH knife pointed, straight, thin, 16cm</i>
LD-003-236	JOSEPH Messer spitz, gerade, breit, 16cm <i>JOSEPH knife pointed, straight, wide, 16cm</i>
LD-003-237	JOSEPH Messer spitz, gebogen, schmal, 16cm <i>JOSEPH knife pointed, curved, thin, 16cm</i>
LD-003-238	JOSEPH Messer spitz, gebogen, breit, 16cm <i>JOSEPH knife pointed, curved, wide, 16cm</i>



**LD-004-250**  
bis / to  
**LD-004-252**

**LD-004-253**  
bis / to  
**LD-004-255**

**LD-003-246**

**LD-003-245**

**LD-003-239**  
bis / to  
**LD-003-242**

**LD-003-243**

**LD-003-244**

**LD-004-256**

<b>Bestell-Nr. Ordering no.</b>	<b>Bezeichnung Description</b>
<b>LD-003-239</b>	JOSEPH Messer stumpf, gerade, schmal, 16cm <i>JOSEPH knife blunt, straight, tide, 16cm</i>
<b>LD-003-240</b>	JOSEPH Messer stumpf, gerade, breit, 16cm <i>JOSEPH knife blunt, straight, wide, 16cm</i>
<b>LD-003-241</b>	JOSEPH Messer stumpf, gebogen, schmal, 16cm <i>JOSEPH knife blunt, curved, tide, 16cm</i>
<b>LD-003-242</b>	JOSEPH Messer stumpf, gebogen, breit, 16cm <i>JOSEPH knife blunt, curved, wide, 16cm</i>
<b>LD-003-243</b>	FOMON Plastikmesser, zweischneidig, gebogen, 15.5cm <i>FOMON double edge knife, double cutting, curved, 15.5cm</i>
<b>LD-003-244</b>	COTTLE Septummesser, gerade, 15cm <i>COTTLE septum knife, straight, 15cm</i>
<b>LD-003-245</b>	JOSEPH Nasenmesser, abgewinkelt, 16.5cm <i>JOSEPH knife, angled, 16.5cm</i>
<b>LD-003-246</b>	MALTZ Nasenmesser <i>MALTZ rhinoplastic knife</i>
<b>LD-004-250</b>	BALLENGER Septum-Schwingmesser, bajonettförmig, 3mm breit, 19.5cm <i>BALLENGER swivel knife, bajonett shaped, 3mm wide, 19.5cm</i>
<b>LD-004-251</b>	BALLENGER Septum-Schwingmesser, bajonettförmig, 4mm breit, 19.5cm <i>BALLENGER swivel knife, bajonett shaped, 4mm wide, 19.5cm</i>
<b>LD-004-252</b>	BALLENGER Septum-Schwingmesser, bajonettförmig, 5mm breit, 19.5cm <i>BALLENGER swivel knife, bajonett shaped, 5mm wide, 19.5cm</i>
<b>LD-004-253</b>	BALLENGER Septum-Schwingmesser, gerade, 3mm breit, 19.5cm <i>BALLENGER swivel knife, straight, 3mm wide, 19.5cm</i>
<b>LD-004-254</b>	BALLENGER Septum-Schwingmesser, gerade, 4mm breit, 19.5cm <i>BALLENGER swivel knife, straight, 4mm wide, 19.5cm</i>
<b>LD-004-255</b>	BALLENGER Septum-Schwingmesser, gerade, 5mm breit, 19.5cm <i>BALLENGER swivel knife, straight, 5mm wide, 19.5cm</i>
<b>LD-004-256</b>	BALLENGER Nasenplastikmesser, 14cm <i>BALLENGER rhinoplasty knife, 14cm</i>



**LK-002-001**  
bis / to  
**LK-002-003**



**LK-002-004 /**  
**LK-002-005**

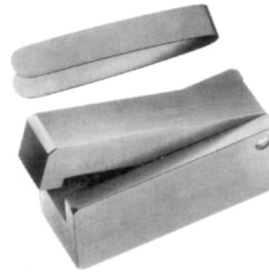

**LR-002-020**



**LR-002-021**

Bestell-Nr. Ordering no.	Bezeichnung Description
<b>LK-002-001</b>	JOSEPH Nasensäge, gerade, 19cm <i>JOSEPH nasal saw, straight, 19cm</i>
<b>LK-002-002</b>	JOSEPH Nasensäge, nach links gebogen, 19cm <i>JOSEPH nasal saw, curved left, 19cm</i>
<b>LK-002-003</b>	JOSEPH Nasensäge, nach rechts gebogen, 19cm <i>JOSEPH nasal saw, curved right, 19cm</i>
<b>LK-002-004</b>	JOSEPH Nasensäge, kniegebogen rechts <i>JOSEPH nasal saw, curved right</i>
<b>LK-002-005</b>	JOSEPH Nasensäge, kniegebogen links <i>JOSEPH nasal saw, curved left</i>
<b>LR-002-020</b>	COTTLE Knochen- und Knorpelquetscher mit Entnahmeklammer, 28mm breit <i>COTTLE bone and cartilage crusher with clamp, 28mm wide</i>
<b>LR-002-021</b>	TOLSDORFF Knochen- und Knorpelquetscher, rund <i>TOLSDORFF bone and cartilage crusher, round</i>



LD-001-006 /  
LD-001-007



LD-001-011



LD-001-001  
bis / to  
LD-001-003



LD-001-010



LD-001-008 /  
LD-001-009



LD-001-005



LD-001-004

Bestell-Nr. Ordering no.	Bezeichnung Description
LD-001-001	COTTLE Septum Elevator, 21cm COTTLE periosteal elevator, 21cm
LD-001-002	COTTLE Septum Elevator, scharf, 19cm COTTLE periosteal elevator, sharp, 19cm
LD-001-003	COTTLE Septum Elevator, stumpf, 19cm COTTLE periosteal elevator, blunt, 19cm
LD-001-004	JOSEPH Septum Elevator, 2mm, 16.5cm JOSEPH periosteal elevator, 2mm, 16.5cm
LD-001-005	HALLE Septum Elevator, 17cm HALLE periosteal elevator, 17cm
LD-001-006	BALLENGER-HAJEK Septum Elevator, 19cm BALLENGER-HAJEK periosteal elevator, 19cm
LD-001-007	BALLENGER-HAJEK Septum Elevator, 22cm BALLENGER-HAJEK periosteal elevator, 22cm
LD-001-008	FREER Septum Elevator, stumpf, 19cm FREER periosteal elevator, blunt, 19cm
LD-001-009	FREER Septum Elevator, scharf/stumpf, 18cm FREER periosteal elevator, sharp/blunt, 18cm
LD-001-010	MASING Septum Elevator, 20cm MASING periosteal elevator, 20cm
LD-001-011	COTTLE Septum Elevator, 22cm COTTLE periosteal elevator, 22cm





**LD-001-029**



**LD-001-060**



**LD-001-150**



**LD-001-096**



**LD-001-090**



**LD-001-151**



**LD-001-097**  
bis / to  
**LD-001-099**



**LD-001-067**  
bis / to  
**LD-001-069**

<b>Bestell-Nr.</b> <b>Ordering no.</b>	<b>Bezeichnung</b> <b>Description</b>
<b>LD-001-029</b>	HOWARTH Doppellelevatorium, 21cm <i>HOWARTH elevator, double ended, 21cm</i>
<b>LD-001-060</b>	FREER Septum Doppellelevator, amerikanisches Modell, 20cm <i>FREER periosteal elevator, double ended, USA model, 20cm</i>
<b>LD-001-067</b>	COTTLE Septum Elevator, 2.5mm, 16cm <i>COTTLE periosteal elevator, 2.5mm, 16cm</i>
<b>LD-001-068</b>	COTTLE Septum Elevator, 3mm, 16cm <i>COTTLE periosteal elevator, 3mm, 16cm</i>
<b>LD-001-069</b>	COTTLE Septum Elevator, 4mm, 16cm <i>COTTLE periosteal elevator, 4mm, 16cm</i>
<b>LD-001-090</b>	KILLIAN Doppellelevatorium, 18cm <i>KILLIAN elevator, double ended, 18cm</i>
<b>LD-001-096</b>	FREER Septum Elevator, scharf, 19cm <i>FREER periosteal elevator, sharp, 19cm</i>
<b>LD-001-097</b>	JOSPEH Septum Elevator, 3mm, 16.5cm <i>JOSEPH periosteal elevator, 3mm, 16.5cm</i>
<b>LD-001-097-1</b>	JOSPEH Septum Elevator, 3.5mm, 16.5cm <i>JOSEPH periosteal elevator, 3.5mm, 16.5cm</i>
<b>LD-001-098</b>	JOSPEH Septum Elevator, 4mm, 16.5cm <i>JOSEPH periosteal elevator, 4mm, 16.5cm</i>
<b>LD-001-099</b>	JOSPEH Septum Elevator, 5mm, 16.5cm <i>JOSEPH periosteal elevator, 5mm, 16.5cm</i>
<b>LD-001-150</b>	FREER Doppellelevator, USA MODELL, 20cm <i>FREER elevator, double ended, USA modell, 20cm</i>
<b>LD-001-151</b>	KILLIAN Septum Elevator, scharf/stumpf, 18cm <i>KILLIAN periosteal elevator, sharp/blunt, 18cm</i>

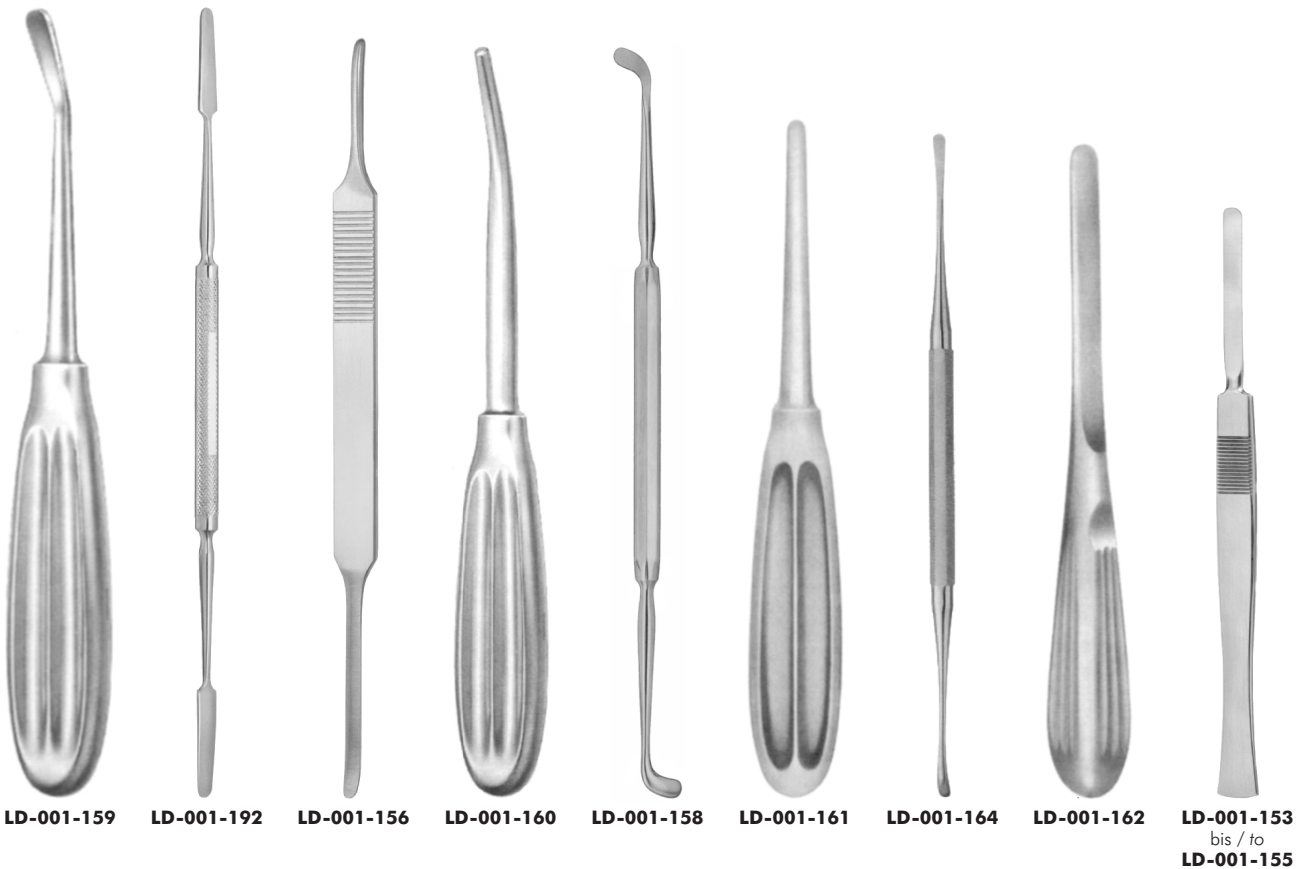

Bestell-Nr. Ordering no.	Bezeichnung Description
LD-001-153	McKENTY Elevator, 3mm, 14.5cm <i>McKENTY elevator, 3mm, 14.5cm</i>
LD-001-154	McKENTY Elevator, 4mm, 14.5cm <i>McKENTY elevator, 4mm, 14.5cm</i>
LD-001-155	McKENTY Elevator, 5mm, 14.5cm <i>McKENTY elevator, 5mm, 14.5cm</i>
LD-001-156	McKENTY Doppelevator, 21.5cm <i>McKENTY elevator, double ended, 21.5cm</i>
LD-001-158	PENNINGTON Doppelevator, nach rechts und links gebogen, 21cm <i>PENNINGTON elevator, double ended, curved right and left, 21cm</i>
LD-001-159	GILLIES Jochbogen-Elevatorium, abgewinkelt, 23cm <i>GILLIES zygoma-elevator, angled, 23cm</i>
LD-001-160	DINGMAN Jochbogen-Elevatorium, gebogen, 21cm <i>DINGMAN zygoma-elevator, curved, 21cm</i>
LD-001-161	GOLDMAN, Nasenfraktur-Elevatorium, rund, konisch verlaufend, 19.5cm <i>GOLDMAN, septum displacer, round, conical shaped, 19.5cm</i>
LD-001-162	BOIES Nasenfraktur-Elevatorium, stumpf, ovales Blatt, 8mm breit, 18.5cm <i>BOIES nasal fracture elevator, blunt, oval blade, 8mm, 18.5cm</i>
LD-001-164	FREER-YASARGIL Dissektor, scharf, 19cm <i>FREER-YASARGIL dissector, sharp, 19cm</i>
LD-001-192	KILLIAN Doppelevatorium, scharf/stumpf, 23cm <i>KILLIAN elevator, double ended, sharp/blunt, 23cm</i>
LD-001-198	Elevatorium, sehr kräftiges Modell, Reposition von Nasenbrüchen, 17cm (ohne Abbildung) <i>Elevator, very strong model, for reposition, 17cm (without illustration)</i>

**LD-001-050 /**  
**LD-001-051**

**LD-001-058**

**LD-001-059**

**LD-001-052**  
 bis / to  
**LD-001-056**

**LD-001-061**  
 bis / to  
**LD-001-065**

**LD-001-057**

**LD-001-066**

<b>Bestell-Nr.</b> <b>Ordering no.</b>	<b>Bezeichnung</b> <b>Description</b>
<b>LD-001-050</b>	MASING Nasenraspel, beidseitig, fein, 21cm <i>MASING nasal rasp, double ended, fine teeth, 21cm</i>
<b>LD-001-051</b>	MASING Nasenraspel, beidseitig, grob, 21cm <i>MASING nasal rasp, double ended, coarse teeth, 21cm</i>
<b>LD-001-052</b>	FOMON Nasenraspel TC, beidseitig, grob, Fig. 1-2, 20cm <i>FOMON nasal rasp TC, double ended, coarse teeth, fig. 1-2, 20cm</i>
<b>LD-001-053</b>	FOMON Nasenraspel TC, beidseitig, grob und mittel, Fig. 3-4, 20cm <i>FOMON nasal rasp TC, double ended, coarse and medium teeth, fig. 3-4, 20cm</i>
<b>LD-001-054</b>	FOMON Nasenraspel TC, beidseitig, mittel, Fig. 5-6, 20cm <i>FOMON nasal rasp TC, double ended, medium teeth, fig. 5-6, Length 20cm</i>
<b>LD-001-055</b>	FOMON Nasenraspel TC, beidseitig, mittel und fein, Fig. 7-8, 20cm <i>FOMON nasal rasp TC, double ended, medium and fine teeth, fig. 7-8, 20cm</i>
<b>LD-001-056</b>	FOMON Nasenraspel TC, beidseitig, fein, Fig. 9-10, 20cm <i>FOMON nasal rasp TC, double ended, fine teeth, fig. 9-10, Length 20cm</i>
<b>LD-001-057</b>	JOSEPH Nasenraspel, fein, 16cm <i>JOSPEH nasal rasp, fine, 16cm</i>
<b>LD-001-058</b>	COTTLE Nasenraspel, 21cm <i>COTTLE nasal rasp, 21cm</i>
<b>LD-001-059</b>	Glabella Nasenraspel, doppelseitig, 20.5cm <i>Glabella nasal rasp, double ended, 20.5cm</i>
<b>LD-001-061</b>	MALTZ Nasenraspel TC, beidseitig, grob, Fig. 1-2, 20cm <i>MALTZ nasal rasp TC, double ended, coarse teeth, fig. 1-2, 20cm</i>
<b>LD-001-062</b>	MALTZ Nasenraspel TC, beidseitig, grob und mittel, Fig. 3-4, 20cm <i>MALTZ nasal rasp TC, double ended, coarse and medium teeth, fig. 3-4, 20cm</i>
<b>LD-001-063</b>	MALTZ Nasenraspel TC, beidseitig, mittel, Fig. 5-6, 20cm <i>MALTZ nasal rasp TC, double ended, medium teeth, fig. 5-6, 20cm</i>
<b>LD-001-064</b>	MALTZ Nasenraspel TC, beidseitig, mittel und fein, Fig. 7-8, 20cm <i>MALTZ nasal rasp TC, double ended, medium and fine teeth, fig. 7-8, 20cm</i>
<b>LD-001-065</b>	MALTZ Nasenraspel TC, beidseitig, fein, Fig. 9-10, 20cm <i>MALTZ nasal rasp TC, double ended, fine teeth, fig. 9-10, 20cm</i>
<b>LD-001-066</b>	JOSEPH Nasenraspel, grob, 16cm <i>JOSPEH nasal rasp, coarse, 16cm</i>



**LD-001-120**  
bis / to  
**LD-001-127**



**LD-001-130**



**LD-001-131**



**LD-001-132**  
bis / to  
**LD-001-135**



**LD-001-128 /**  
**LD-001-129**

Bestell-Nr. Ordering no.	Bezeichnung Description
<b>LD-001-120</b>	PARKES Nasenraspel TC, Fig. 1, 20.5cm <i>PARKES nasal rasp TC, fig. 1, 20.5cm</i>
<b>LD-001-121</b>	PARKES Nasenraspel TC, Fig. 2, 20.5cm <i>PARKES nasal rasp TC, fig. 2, 20.5cm</i>
<b>LD-001-122</b>	PARKES Nasenraspel TC, Fig. 3, 20.5cm <i>PARKES nasal rasp TC, fig. 3, 20.5cm</i>
<b>LD-001-123</b>	PARKES Nasenraspel TC, Fig. 4, 20.5cm <i>PARKES nasal rasp TC, fig. 4, 20.5cm</i>
<b>LD-001-124</b>	PARKES Nasenraspel TC, Fig. 5, 20.5cm <i>PARKES nasal rasp TC, fig. 5, 20.5cm</i>
<b>LD-001-125</b>	PARKES Nasenraspel TC, Fig. 6, 20.5cm <i>PARKES nasal rasp TC, fig. 6, 20.5cm</i>
<b>LD-001-126</b>	PARKES Nasenraspel TC, Fig. 7, 20.5cm <i>PARKES nasal rasp TC, fig. 7, 20.5cm</i>
<b>LD-001-127</b>	PARKES Nasenraspel TC, Fig. 8, 20.5cm <i>PARKES nasal rasp TC, fig. 8, 20.5cm</i>
<b>LD-001-128</b>	MILLER Doppelraspel TC, querverieft, 16cm <i>MILLER double ended rasp, cross serrated, 16cm</i>
<b>LD-001-129</b>	MILLER Doppelraspel TC, karogerieft, 16cm <i>MILLER double ended rasp, square serrated, 16cm</i>
<b>LD-001-130</b>	AUFRICHT Glabella Nasenraspel TC, 20.5cm <i>AUFRICHT glabella nasal rasp TC, 20.5cm</i>
<b>LD-001-131</b>	KLEINERT-KUTZ Nasenraspel, doppelendig, vierseitig, 20.5cm <i>KLEINERT-KUTZ nasal rasp, double ended, 4 sided, 20.5cm</i>
<b>LD-001-132</b>	MALTZ Nasenraspel mit 2 Blutrinnen, auf Zug schneidend, breites Modell, 16cm <i>MALTZ nasal rasp with 2 blood groves, down cutting, large model, 16cm</i>
<b>LD-001-133</b>	MALTZ Nasenraspel mit 2 Blutrinnen, auf Zug schneidend, schmales Modell, 16cm <i>MALTZ nasal rasp with 2 blood groves, down cutting, small model, 16cm</i>
<b>LD-001-134</b>	MALTZ Nasenraspel mit 2 Blutrinnen, auf Druck schneidend, breites Modell, 16cm <i>MALTZ nasal rasp with 2 blood groves, up cutting, large model, 16cm</i>
<b>LD-001-135</b>	MALTZ Nasenraspel mit 2 Blutrinnen, auf Druck schneidend, schmales Modell, 16cm <i>MALTZ nasal rasp with 2 blood groves, up cutting, small model, 16cm</i>



**LD-001-136**  
bis / to  
**LD-001-138**



**LD-001-143 /**  
**LD-001-144**



**LD-001-139 /**  
**LD-001-140**



**LD-001-145**



**LD-001-141 /**  
**LD-001-142**

<b>Bestell-Nr.</b> <b>Ordering no.</b>	<b>Bezeichnung</b> <b>Description</b>
<b>LD-001-136</b>	AUFRICHT Galbellaraspel, auf Zug und Druck schneidend, 21cm <i>AUFRICHT glabella rasp, up and down cutting, 21cm</i>
<b>LD-001-137</b>	AUFRICHT Galbellaraspel, auf Zug schneidend, 21cm <i>AUFRICHT glabella rasp, down cutting, 21cm</i>
<b>LD-001-138</b>	AUFRICHT Galbellaraspel, auf Druck schneidend, 21cm <i>AUFRICHT glabella rasp, up cutting, 21cm</i>
<b>LD-001-139</b>	PARKES Nasenraspel, 20 feine Zähne, auf Zug schneidend, 20.5cm <i>PARKES nasal rasp, 20 fine teeth, down cutting, 20.5cm</i>
<b>LD-001-140</b>	PARKES Nasenraspel, 11 grobe Zähne, auf Zug schneidend, 20.5cm <i>PARKES nasal rasp, 11 coarse teeth, down cutting, 20.5cm</i>
<b>LD-001-141</b>	LEWIS Nasenraspel, feingezahnt, auf Zug schneidend, 18cm <i>LEWIS nasal rasp, fine teeth, down cutting, 18cm</i>
<b>LD-001-142</b>	LEWIS Nasenraspel, grobgezahnt, auf Zug schneidend, 18cm <i>LEWIS nasal rasp, coarse teeth, down cutting, 18cm</i>
<b>LD-001-143</b>	FOMON Nasenraspel beidseitig, fein, 21cm <i>FOMON nasal rasp, double ended, fine teeth, 21cm</i>
<b>LD-001-144</b>	FOMON Nasenraspel beidseitig, grob, 21cm <i>FOMON nasal rasp, double ended, coarse teeth, 21cm</i>
<b>LD-001-145</b>	AUFRICHT Nasenraspel, diamantbeschichtet, 20.5cm <i>AUFRICHT nasal rasp, diamond coated, 20.5cm</i>



LD-001-149



LD-001-146



LD-001-157



LD-001-147 /  
LD-001-148



LD-001-152

Bestell-Nr. Ordering no.	Bezeichnung Description
LD-001-146	COTTLE Nasenraspel, diamantbeschichtet, 20.5cm <i>COTTLE nasal rasp, diamond coated, 20.5cm</i>
LD-001-147	Nasenraspel gerade, diamantbeschichtet, 19cm <i>Nasal rasp straight, diamond coated, 19cm</i>
LD-001-148	Nasenraspel rückwärts gebogen, diamantbeschichtet, 19cm <i>Nasal rasp curved backwards, diamond coated, 19cm</i>
LD-001-149	FOMON Nasenraspel beidseitig, diamantbeschichtet, 21cm <i>FOMON nasal rasp, double ended, diamond coated, 21cm</i>
LD-001-152	COTTLE Raspatorium, scharf, 8mm, 19cm <i>COTTLE raspatory, sharp, 8mm, 19cm</i>
LD-001-157	PARKES Nasenraspel TC, Fig. 5, 20.5cm <i>PARKES nasal rasp TC, fig. 5, 20.5cm</i>



**LD-001-040 /  
LD-001-043/  
LD-001-044**

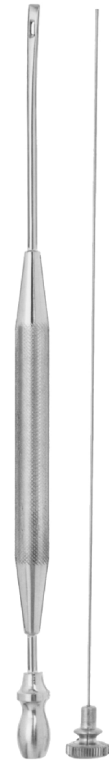

**LD-001-042**



**LH-001-286**  
bis / to  
**LH-001-287**



**LH-001-088 /  
LH-001-089**

<b>Bestell-Nr. Ordering no.</b>	<b>Bezeichnung Description</b>
<b>LD-001-040</b>	GUILLEN Saug-Raspatorium, biegsam, scharf, 20cm <i>GUILLEN suction raspatory, malleable, sharp, 20cm</i>
<b>LD-001-042</b>	GORNEY Saugelevator, mit Mandrin, 3mm breit, 19cm <i>GORNEY suction elevator, with mandrin, 3mm wide, 19cm</i>
<b>LD-001-043</b>	GUILLEN Saug-Raspatorium, biegsam, scharf, Spitze nach links gebogen, 20cm <i>GUILLEN suction raspatory, malleable, sharp, tip curved to left, 20cm</i>
<b>LD-001-044</b>	GUILLEN Saug-Raspatorium, biegsam, scharf, Spitze nach rechts gebogen, 20cm <i>GUILLEN suction raspatory, malleable, sharp, tip curved to right, 20cm</i>
<b>LH-001-088</b>	FRAZIER Spülkanüle, 45° gebogen, Ø 12 Fr., NL 90mm <i>FRAZIER suction cannula, 45° curved, Ø 12 Ch., WL 90mm</i>
<b>LH-001-089</b>	FRAZIER Spülkanüle, 45° gebogen, Ø 15 Fr., NL 90mm <i>FRAZIER suction cannula, 45° curved, Ø 15 Ch., WL 90mm</i>
<b>LH-001-285</b>	Saugrohr gebogen, konisch, LL, Ø 3.0mm, NL 115mm <i>Suction tube curved, conical, LL, Ø 3.0mm, WL 115mm</i>
<b>LH-001-286</b>	Saugrohr gebogen, konisch, LL, Ø 3.5mm, NL 115mm <i>Suction tube curved, conical, LL, Ø 3.5mm, WL 115mm</i>
<b>LH-001-287</b>	Saugrohr gebogen, konisch, LL, Ø 4.5mm, NL 130mm <i>Suction tube curved, conical, LL, Ø 4.5mm, WL 130mm</i>
<b>LH-001-288</b>	Saugrohr gerade, konisch, LL, Ø 3.0mm, NL 175mm <i>Suction tube curved, conical, LL, Ø 3.0mm, WL 175mm</i>





**LD-002-010 /  
LD-002-011**



**LD-002-012  
bis / to  
LD-002-017**



**LD-002-001  
bis / to  
LD-002-003**



**LD-002-004**



**LD-002-300**

<b>Bestell-Nr. Ordering no.</b>	<b>Bezeichnung Description</b>
<b>LD-002-001</b>	MASING Meißel, leicht gebogen, Dorn rechts, 18cm <i>MASING chisel, slightly curved, guard right side, 18cm</i>
<b>LD-002-002</b>	MASING Meißel, leicht gebogen, Dorn links, 18cm <i>MASING chisel, slightly curved, guard left side, 18cm</i>
<b>LD-002-003</b>	MASING Meißel, gerade, Dorn, 18cm <i>MASING chisel, straight, guard, 18cm</i>
<b>LD-002-004</b>	MASING Meißel, gerade, Dorn beidseitig, 10mm Schnittbreite, 16cm <i>MASING chisel, straight, double guard, 10mm cutting width, 16cm</i>
<b>LD-002-010</b>	WALTER Meißel, hohl, 3mm, 19cm <i>WALTER chisel, hollow, 3mm, 19cm</i>
<b>LD-002-011</b>	WALTER Meißel, hohl, 4.5mm, 19cm <i>WALTER chisel, hollow, 4.5mm, 19cm</i>
<b>LD-002-012</b>	WALTER Meißel, flach, 2mm, 19cm <i>WALTER chisel, flat, 2mm, 19cm</i>
<b>LD-002-013</b>	WALTER Meißel, flach, 3mm, 19cm <i>WALTER chisel, flat, 3mm, 19cm</i>
<b>LD-002-014</b>	WALTER Meißel, flach, 4mm, 19cm <i>WALTER chisel, flat, 4mm, 19cm</i>
<b>LD-002-015</b>	WALTER Meißel, flach, 7mm, 19cm <i>WALTER chisel, flat, 7mm, 19cm</i>
<b>LD-002-016</b>	WALTER Meißel, flach, 9mm, 19cm <i>WALTER chisel, flat, 9mm, 19cm</i>
<b>LD-002-017</b>	WALTER Meißel, flach, 12mm, 19cm <i>WALTER chisel, flat, 12mm, 19cm</i>
<b>LD-002-300</b>	PECK Meißel, Vierkantgriff, 4mm breit, 15cm <i>PECK chisel, square handle, 4mm wide, 15cm</i>

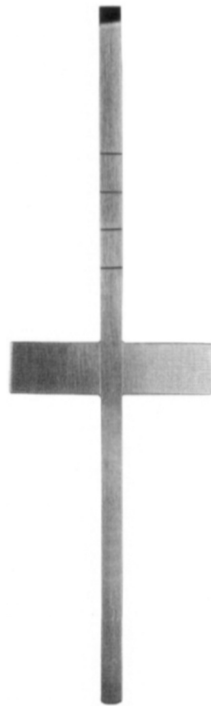

**LD-002-085**  
bis / to  
**LD-002-089**



**LD-002-035**  
bis / to  
**LD-002-038**



**LD-002-070 /**  
**LD-002-071**

<b>Bestell-Nr.</b> <b>Ordering no.</b>	<b>Bezeichnung</b> <b>Description</b>
<b>LD-002-035</b>	COTTLE Flachmeißel, graduert, 4mm, 18cm <i>COTTLE flat chisel, graduated, 4mm, 18cm</i>
<b>LD-002-036</b>	COTTLE Flachmeißel, graduert, 6mm, 18cm <i>COTTLE flat chisel, graduated, 6mm, 18cm</i>
<b>LD-002-037</b>	COTTLE Flachmeißel, graduert, 9mm, 18cm <i>COTTLE flat chisel, graduated, 9mm, 18cm</i>
<b>LD-002-038</b>	COTTLE Flachmeißel, graduert, 12mm, 18cm <i>COTTLE flat chisel, graduated, 12mm, 18cm</i>
<b>LD-002-070</b>	FREER Septum-Flachmeißel, 4mm, gerade <i>FREER septum flat chisel, 4mm, straight</i>
<b>LD-002-071</b>	FREER Septum-Flachmeißel, 4mm, gebogen <i>FREER septum flat chisel, 4mm, curved</i>
<b>LD-002-085</b>	COTTLE Flachmeißel, graduert, mit Griffbalken, gerade, 2mm breit, 18.5cm <i>COTTLE flat chisel, graduated, with crossbar, straight, 2mm wide, 18.5cm</i>
<b>LD-002-086</b>	COTTLE Flachmeißel, graduert, mit Griffbalken, gerade, 4mm breit, 18.5cm <i>COTTLE flat chisel, graduated, with crossbar, straight, 4mm wide, 18.5cm</i>
<b>LD-002-087</b>	COTTLE Flachmeißel, graduert, mit Griffbalken, gerade, 7mm breit, 18.5cm <i>COTTLE flat chisel, graduated, with crossbar, straight, 7mm wide, 18.5cm</i>
<b>LD-002-088</b>	COTTLE Flachmeißel, graduert, mit Griffbalken, gerade, 9mm breit, 18.5cm <i>COTTLE flat chisel, graduated, with crossbar, straight, 9mm wide, 18.5cm</i>
<b>LD-002-089</b>	COTTLE Flachmeißel, graduert, mit Griffbalken, gerade, 12mm breit, 18.5cm <i>COTTLE flat chisel, graduated, with crossbar, straight, 12mm wide, 18.5cm</i>



**LD-002-140**  
bis / to  
**LD-002-144**



**LD-002-115**  
bis / to  
**LD-002-124**

Bestell-Nr. Ordering no.	Bezeichnung Description
<b>LD-002-115</b>	PARTSCH Flachmeißel, gerade, 2mm breit, 13.5cm <i>PARTSCH flat chisel, straight, 2mm wide, 13.5cm</i>
<b>LD-002-116</b>	PARTSCH Flachmeißel, gerade, 3mm breit, 13.5cm <i>PARTSCH flat chisel, straight, 3mm wide, 13.5cm</i>
<b>LD-002-117</b>	PARTSCH Flachmeißel, gerade, 4mm breit, 13.5cm <i>PARTSCH flat chisel, straight, 4mm wide, 13.5cm</i>
<b>LD-002-118</b>	PARTSCH Flachmeißel, gerade, 5mm breit, 13.5cm <i>PARTSCH flat chisel, straight, 5mm wide, 13.5cm</i>
<b>LD-002-119</b>	PARTSCH Flachmeißel, gerade, 6mm breit, 13.5cm <i>PARTSCH flat chisel, straight, 6mm wide, 13.5cm</i>
<b>LD-002-120</b>	PARTSCH Flachmeißel, gerade, 2mm breit, 17cm <i>PARTSCH flat chisel, straight, 2mm wide, 17cm</i>
<b>LD-002-121</b>	PARTSCH Flachmeißel, gerade, 3mm breit, 17cm <i>PARTSCH flat chisel, straight, 3mm wide, 17cm</i>
<b>LD-002-122</b>	PARTSCH Flachmeißel, gerade, 4mm breit, 17cm <i>PARTSCH flat chisel, straight, 4mm wide, 17cm</i>
<b>LD-002-123</b>	PARTSCH Flachmeißel, gerade, 5mm breit, 17cm <i>PARTSCH flat chisel, straight, 5mm wide, 17cm</i>
<b>LD-002-124</b>	PARTSCH Flachmeißel, gerade, 6mm breit, 17cm <i>PARTSCH flat chisel, straight, 6mm wide, 17cm</i>
<b>LD-002-140</b>	Flachmeißel, gerade, 8mm breit, 13.5cm <i>Flat chisel, straight, 8mm wide, 13.5cm</i>
<b>LD-002-141</b>	Flachmeißel, gerade, 10mm breit, 13.5cm <i>Flat chisel, straight, 10mm wide, 13.5cm</i>
<b>LD-002-142</b>	Flachmeißel, gerade, 12mm breit, 13.5cm <i>Flat chisel, straight, 12mm wide, 13.5cm</i>
<b>LD-002-143</b>	Flachmeißel, gerade, 14mm breit, 13.5cm <i>Flat chisel, straight, 14mm wide, 13.5cm</i>
<b>LD-002-144</b>	Flachmeißel, gerade, 16mm breit, 13.5cm <i>Flat chisel, straight, 16mm wide, 13.5cm</i>



**LD-002-072**  
bis / to  
**LD-002-074**

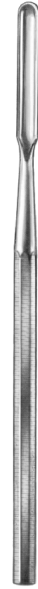

**LD-002-114**



**LD-002-125**  
bis / to  
**LD-002-134**

Bestell-Nr. Ordering no.	Bezeichnung Description
<b>LD-002-072</b>	KILLIAN-CLAUS Septum Hohlmeißel, bajonettförmig, 5mm breit, mit Kerbe, 16.5cm <i>KILLIAN-CLAUS septum gouge, bajonett shaped, 5mm wide, with V-shape, 16.5cm</i>
<b>LD-002-073</b>	KILLIAN-CLAUS Septum Hohlmeißel, bajonettförmig, 5mm breit, mit runder Schneide, 16.5cm <i>KILLIAN-CLAUS septum gouge, bajonett shaped, 5mm wide, with round shape, 16.5cm</i>
<b>LD-002-074</b>	KILLIAN-CLAUS Septum Hohlmeißel, bajonettförmig, 5mm breit, mit gerader Schneide, 16.5cm <i>KILLIAN-CLAUS septum gouge, bajonett shaped, 5mm wide, with straight shape, 16.5cm</i>
<b>LD-002-114</b>	FREER Septum Hohlmeißel, 6mm, gerade, 15cm <i>FREER septum gouge, 6mm, straight, 15cm</i>
<b>LD-002-125</b>	PARTSCH Hohlmeißel, gerade, 2mm breit, 13.5cm <i>PARTSCH gouge, straight, 2mm wide, 13.5cm</i>
<b>LD-002-126</b>	PARTSCH Hohlmeißel, gerade, 3mm breit, 13.5cm <i>PARTSCH gouge, straight, 3mm wide, 13.5cm</i>
<b>LD-002-127</b>	PARTSCH Hohlmeißel, gerade, 4mm breit, 13.5cm <i>PARTSCH gouge, straight, 4mm wide, 13.5cm</i>
<b>LD-002-128</b>	PARTSCH Hohlmeißel, gerade, 5mm breit, 13.5cm <i>PARTSCH gouge, straight, 5mm wide, 13.5cm</i>
<b>LD-002-129</b>	PARTSCH Hohlmeißel, gerade, 6mm breit, 13.5cm <i>PARTSCH gouge, straight, 6mm wide, 13.5cm</i>
<b>LD-002-130</b>	PARTSCH Hohlmeißel, gerade, 2mm breit, 17cm <i>PARTSCH gouge, straight, 2mm wide, 17cm</i>
<b>LD-002-131</b>	PARTSCH Hohlmeißel, gerade, 3mm breit, 17cm <i>PARTSCH gouge, straight, 3mm wide, 17cm</i>
<b>LD-002-132</b>	PARTSCH Hohlmeißel, gerade, 4mm breit, 17cm <i>PARTSCH gouge, straight, 4mm wide, 17cm</i>
<b>LD-002-133</b>	PARTSCH Hohlmeißel, gerade, 5mm breit, 17cm <i>PARTSCH gouge, straight, 5mm wide, 17cm</i>
<b>LD-002-134</b>	PARTSCH Hohlmeißel, gerade, 6mm breit, 17cm <i>PARTSCH gouge, straight, 6mm wide, 17cm</i>



**LD-002-160**  
bis / to  
**LD-002-164**



**LD-002-350**



**LD-002-344**



**LD-002-377**  
bis / to  
**LD-002-379**



**LD-002-145**  
bis / to  
**LD-002-149**

Bestell-Nr. Ordering no.	Bezeichnung Description
<b>LD-002-145</b>	Hohlmeißel, gerade, 8mm breit, 13.5cm <i>Gouge, straight, 8mm wide, 13.5cm</i>
<b>LD-002-146</b>	Hohlmeißel, gerade, 10mm breit, 13.5cm <i>Gouge, straight, 10mm wide, 13.5cm</i>
<b>LD-002-147</b>	Hohlmeißel, gerade, 12mm breit, 13.5cm <i>Gouge, straight, 12mm wide, 13.5cm</i>
<b>LD-002-148</b>	Hohlmeißel, gerade, 14mm breit, 13.5cm <i>Gouge, straight, 14mm wide, 13.5cm</i>
<b>LD-002-149</b>	Hohlmeißel, gerade, 16mm breit, 13.5cm <i>Gouge, straight, 16mm wide, 13.5cm</i>
<b>LD-002-160</b>	MINI-LEXER Hohlmeißel, 4mm breit, 18cm <i>MINI-LEXER gouge, 4mm wide, 18cm</i>
<b>LD-002-161</b>	MINI-LEXER Hohlmeißel, 6mm breit, 18cm <i>MINI-LEXER gouge, 6mm wide, 18cm</i>
<b>LD-002-162</b>	MINI-LEXER Hohlmeißel, 8mm breit, 18cm <i>MINI-LEXER gouge, 8mm wide, 18cm</i>
<b>LD-002-163</b>	MINI-LEXER Hohlmeißel, 10mm breit, 18cm <i>MINI-LEXER gouge, 10mm wide, 18cm</i>
<b>LD-002-164</b>	MINI-LEXER Hohlmeißel, 12mm breit, 18cm <i>MINI-LEXER gouge, 12mm wide, 18cm</i>
<b>LD-002-344</b>	RUBIN Hohlmeißel, mit Halteknopf, gerade, 16.5cm <i>RUBIN gouge, with stabilizer, straight, 16.5cm</i>
<b>LD-002-350</b>	PARKES Höcker-Hohlmeißel, 6.5mm breit, 18cm <i>PARKES hump gouge, 6.5mm wide, 18cm</i>
<b>LD-002-377</b>	MC INDOE Hohlmeißel, 11mm, 14.5cm <i>MC INDOE gouge, 11mm, 14.5cm</i>
<b>LD-002-378</b>	MC INDOE Hohlmeißel, 13mm, 14.5cm <i>MC INDOE gouge, 13mm, 14.5cm</i>
<b>LD-002-379</b>	MC INDOE Hohlmeißel, 15mm, 14.5cm <i>MC INDOE gouge, 15mm, 14.5cm</i>



**LD-002-075**  
bis / to  
**LD-002-078**



**LD-002-079**  
bis / to  
**LD-002-084**



**LD-002-090 /**  
**LD-002-091**



**LD-002-092**  
bis / to  
**LD-002-096**

Bestell-Nr. Ordering no.	Bezeichnung Description
<b>LD-002-075</b>	COTTLE Osteotom, graduiert, gerade, 4mm breit, 18.5cm COTTLE osteotome, graduated, straight, 4mm wide, 18.5cm
<b>LD-002-076</b>	COTTLE Osteotom, graduiert, gerade, 6mm breit, 18.5cm COTTLE osteotome, graduated, straight, 6mm wide, 18.5cm
<b>LD-002-077</b>	COTTLE Osteotom, graduiert, gerade, 9mm breit, 18.5cm COTTLE osteotome, graduated, straight, 9mm wide, 18.5cm
<b>LD-002-078</b>	COTTLE Osteotom, graduiert, gerade, 12mm breit, 18.5cm COTTLE osteotome, graduated, straight, 12mm wide, 18.5cm
<b>LD-002-079</b>	COTTLE Osteotom, graduiert, mit Griffbalken, gerade, 4mm breit, 18.5cm COTTLE osteotome, graduated, with crossbar, straight, 4mm wide, 18.5cm
<b>LD-002-080</b>	COTTLE Osteotom, graduiert, mit Griffbalken, gerade, 6mm breit, 18.5cm COTTLE osteotome, graduated, with crossbar, straight, 6mm wide, 18.5cm
<b>LD-002-081</b>	COTTLE Osteotom, graduiert, mit Griffbalken, gerade, 9mm breit, 18.5cm COTTLE osteotome, graduated, with crossbar, straight, 9mm wide, 18.5cm
<b>LD-002-082</b>	COTTLE Osteotom, graduiert, mit Griffbalken, gerade, 12mm breit, 18.5cm COTTLE osteotome, graduated, with crossbar, straight, 12mm wide, 18.5cm
<b>LD-002-083</b>	COTTLE Osteotom, graduiert, mit Griffbalken, gebogen, 4mm breit, 18.5cm COTTLE osteotome, graduated, with crossbar, curved, 4mm wide, 18.5cm
<b>LD-002-084</b>	COTTLE Osteotom, graduiert, mit Griffbalken, gebogen, 6mm breit, 18.5cm COTTLE osteotome, graduated, with crossbar, curved, 6mm wide, 18.5cm
<b>LD-002-090</b>	COTTLE Osteotom, mit Führungsdorn, graduiert, gerade, 5mm breit, 18.5cm COTTLE osteotome, with single guard, graduated, straight, 5mm wide, 18.5cm
<b>LD-002-091</b>	COTTLE Osteotom, mit Führungsdorn, graduiert, mit Griffbalken, gerade, 5mm breit, 18.5cm COTTLE osteotome, with single guard, graduated, with cross bar, straight, 5mm wide, 18.5cm
<b>LD-002-092</b>	COTTLE Osteotom, mit beidseitigem Führungsdorn, graduiert, mit Griffbalken, gerade, 10mm breit, 18.5cm COTTLE osteotome, with double guard, graduated, with cross bar, straight, 10mm wide, 18.5cm
<b>LD-002-094</b>	COTTLE Osteotom, mit beidseitigem Führungsdorn, graduiert, mit Griffbalken, gerade, 12mm breit, 18.5cm COTTLE osteotome, with double guard, graduated, with cross bar, straight, 12mm wide, 18.5cm
<b>LD-002-095</b>	COTTLE Osteotom, mit beidseitigem Führungsdorn, graduiert, mit Griffbalken, gerade, 14mm breit, 18.5cm COTTLE osteotome, with double guard, graduated, with cross bar, straight, 14mm wide, 18.5cm
<b>LD-002-096</b>	COTTLE Osteotom, mit beidseitigem Führungsdorn, graduiert, mit Griffbalken, gerade, 16mm breit, 18.5cm COTTLE osteotome, with double guard, graduated, with cross bar, straight, 16mm wide, 18.5cm



**LD-002-097**  
bis / to  
**LD-002-099**



**LD-002-155**  
bis / to  
**LD-002-159**



**LD-002-110**  
bis / to  
**LD-002-113**



**LD-002-135**  
bis / to  
**LD-002-139**

Bestell-Nr. Ordering no.	Bezeichnung Description
<b>LD-002-097</b>	Osteotom "Würzburger Modell", mit beidseitigem Führungsdorn, abgebogen, 3mm breit, 18cm <i>Osteotome "Würzburger Modell", with double guard, curved, 3mm wide, 18cm</i>
<b>LD-002-098</b>	Osteotom "Würzburger Modell", mit linksseitigem Führungsdorn, abgebogen, 3mm breit, 18cm <i>Osteotome "Würzburger Modell", with single guard left, curved, 3mm wide, 18cm</i>
<b>LD-002-099</b>	Osteotom "Würzburger Modell", mit rechtsseitigem Führungsdorn, abgebogen, 3mm breit, 18cm <i>Osteotome "Würzburger Modell", with single guard right, curved, 3mm wide, 18cm</i>
<b>LD-002-110</b>	FOMON Osteotom, mit einseitiger verrundeter Ecke, 4mm breit, 16cm <i>FOMON osteotome, one rounded edge, 4mm wide, 16cm</i>
<b>LD-002-111</b>	FOMON Osteotom, mit einseitiger verrundeter Ecke, 5mm breit, 16cm <i>FOMON osteotome, one rounded edge, 5mm wide, 16cm</i>
<b>LD-002-112</b>	FOMON Osteotom, mit einseitiger verrundeter Ecke, 6mm breit, 16cm <i>FOMON osteotome, one rounded edge, 6mm wide, 16cm</i>
<b>LD-002-113</b>	FOMON Osteotom, mit einseitiger verrundeter Ecke, 7mm breit, 16cm <i>FOMON osteotome, one rounded edge, 7mm wide, 16cm</i>
<b>LD-002-135</b>	OSTEOTOM, gerade, 8mm breit, 13.5cm <i>OSTEOTOME, straight, 8mm wide, 13.5cm</i>
<b>LD-002-136</b>	OSTEOTOM, gerade, 10mm breit, 13.5cm <i>OSTEOTOME, straight, 10mm wide, 13.5cm</i>
<b>LD-002-137</b>	OSTEOTOM, gerade, 12mm breit, 13.5cm <i>OSTEOTOME, straight, 12mm wide, 13.5cm</i>
<b>LD-002-138</b>	OSTEOTOM, gerade, 14mm breit, 13.5cm <i>OSTEOTOME, straight, 14mm wide, 13.5cm</i>
<b>LD-002-139</b>	OSTEOTOM, gerade, 16mm breit, 13.5cm <i>OSTEOTOME, straight, 16mm wide, 13.5cm</i>
<b>LD-002-155</b>	MINI-LEXER Osteotome, 4mm breit, 18cm <i>MINI-LEXER osteotome, 4mm wide, 18cm</i>
<b>LD-002-156</b>	MINI-LEXER Osteotome, 6mm breit, 18cm <i>MINI-LEXER osteotome, 6mm wide, 18cm</i>
<b>LD-002-157</b>	MINI-LEXER Osteotome, 8mm breit, 18cm <i>MINI-LEXER osteotome, 8mm wide, 18cm</i>
<b>LD-002-158</b>	MINI-LEXER Osteotome, 10mm breit, 18cm <i>MINI-LEXER osteotome, 10mm wide, 18cm</i>
<b>LD-002-159</b>	MINI-LEXER Osteotome, 12mm breit, 18cm <i>MINI-LEXER osteotome, 12mm wide, 18cm</i>





**LD-002-301**  
bis / to  
**LD-002-310**



**LD-002-311**  
bis / to  
**LD-002-316**

<b>Bestell-Nr. Ordering no.</b>	<b>Bezeichnung Description</b>
<b>LD-002-301</b>	SHEEHAN Osteotom, gerade, 6-Kantgriff, gerade, 2mm breit, 16cm <i>SHEEHAN osteotome, straight, hexagon handle, straight, 2mm wide, 16cm</i>
<b>LD-002-302</b>	SHEEHAN Osteotom, gerade, 6-Kantgriff, gerade, 3mm breit, 16cm <i>SHEEHAN osteotome, straight, hexagon handle, straight, 3mm wide, 16cm</i>
<b>LD-002-303</b>	SHEEHAN Osteotom, gerade, 6-Kantgriff, gerade, 4mm breit, 16cm <i>SHEEHAN osteotome, straight, hexagon handle, straight, 4mm wide, 16cm</i>
<b>LD-002-304</b>	SHEEHAN Osteotom, gerade, 6-Kantgriff, gerade, 5mm breit, 16cm <i>SHEEHAN osteotome, straight, hexagon handle, straight, 5mm wide, 16cm</i>
<b>LD-002-305</b>	SHEEHAN Osteotom, gerade, 6-Kantgriff, gerade, 6mm breit, 16cm <i>SHEEHAN osteotome, straight, hexagon handle, straight, 6mm wide, 16cm</i>
<b>LD-002-306</b>	SHEEHAN Osteotom, gerade, 6-Kantgriff, gerade, 8mm breit, 16cm <i>SHEEHAN osteotome, straight, hexagon handle, straight, 8mm wide, 16cm</i>
<b>LD-002-307</b>	SHEEHAN Osteotom, gerade, 6-Kantgriff, gerade, 9mm breit, 16cm <i>SHEEHAN osteotome, straight, hexagon handle, straight, 9mm wide, 16cm</i>
<b>LD-002-308</b>	SHEEHAN Osteotom, gerade, 6-Kantgriff, gerade, 10mm breit, 16cm <i>SHEEHAN osteotome, straight, hexagon handle, straight, 10mm wide, 16cm</i>
<b>LD-002-309</b>	SHEEHAN Osteotom, gerade, 6-Kantgriff, gerade, 11mm breit, 16cm <i>SHEEHAN osteotome, straight, hexagon handle, straight, 11mm wide, 16cm</i>
<b>LD-002-310</b>	SHEEHAN Osteotom, gerade, 6-Kantgriff, gerade, 12mm breit, 16cm <i>SHEEHAN osteotome, straight, hexagon handle, straight, 12mm wide, 16cm</i>
<b>LD-002-311</b>	Mini-Osteotom, gerade, 2mm breit, 12.5cm <i>Mini osteotome, straight, 2mm wide, 12.5cm</i>
<b>LD-002-312</b>	Mini-Osteotom, gerade, 4mm breit, 12.5cm <i>Mini osteotome, straight, 4mm wide, 12.5cm</i>
<b>LD-002-313</b>	Mini-Osteotom, gerade, 6mm breit, 12.5cm <i>Mini osteotome, straight, 6mm wide, 12.5cm</i>
<b>LD-002-314</b>	Mini-Osteotom, gerade, 8mm breit, 12.5cm <i>Mini osteotome, straight, 8mm wide, 12.5cm</i>
<b>LD-002-315</b>	Mini-Osteotom, gerade, 10mm breit, 12.5cm <i>Mini osteotome, straight, 10mm wide, 12.5cm</i>
<b>LD-002-316</b>	Mini-Osteotom, gerade, 12mm breit, 12.5cm <i>Mini osteotome, straight, 12mm wide, 12.5cm</i>

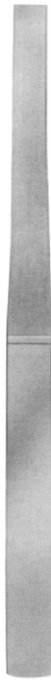

**LD-002-323**  
bis / to  
**LD-002-334**



**LD-002-317**  
bis / to  
**LD-002-322**

Bestell-Nr. Ordering no.	Bezeichnung Description
<b>LD-002-317</b>	Mini-Osteotom, gebogen, 2mm breit, 12.5cm <i>Mini osteotome, curved, 2mm wide, 12.5cm</i>
<b>LD-002-318</b>	Mini-Osteotom, gebogen, 4mm breit, 12.5cm <i>Mini osteotome, curved, 4mm wide, 12.5cm</i>
<b>LD-002-319</b>	Mini-Osteotom, gebogen, 6mm breit, 12.5cm <i>Mini osteotome, curved, 6mm wide, 12.5cm</i>
<b>LD-002-320</b>	Mini-Osteotom, gebogen, 8mm breit, 12.5cm <i>Mini osteotome, curved, 8mm wide, 12.5cm</i>
<b>LD-002-321</b>	Mini-Osteotom, gebogen, 10mm breit, 12.5cm <i>Mini osteotome, curved, 10mm wide, 12.5cm</i>
<b>LD-002-322</b>	Mini-Osteotom, gebogen, 12mm breit, 12.5cm <i>Mini osteotome, curved, 12mm wide, 12.5cm</i>
<b>LD-002-323</b>	CONVERSE Osteotom, gerade, 2mm breit, 18cm <i>CONVERSE osteotome, straight, 2mm wide, 18cm</i>
<b>LD-002-324</b>	CONVERSE Osteotom, gerade, 3mm breit, 18cm <i>CONVERSE osteotome, straight, 3mm wide, 18cm</i>
<b>LD-002-325</b>	CONVERSE Osteotom, gerade, 4mm breit, 18cm <i>CONVERSE osteotome, straight, 4mm wide, 18cm</i>
<b>LD-002-326</b>	CONVERSE Osteotom, gerade, 5mm breit, 18cm <i>CONVERSE osteotome, straight, 5mm wide, 18cm</i>
<b>LD-002-327</b>	CONVERSE Osteotom, gerade, 6mm breit, 18cm <i>CONVERSE osteotome, straight, 6mm wide, 18cm</i>
<b>LD-002-328</b>	CONVERSE Osteotom, gerade, 7mm breit, 18cm <i>CONVERSE osteotome, straight, 7mm wide, 18cm</i>
<b>LD-002-329</b>	CONVERSE Osteotom, gerade, 8mm breit, 18cm <i>CONVERSE osteotome, straight, 8mm wide, 18cm</i>
<b>LD-002-330</b>	CONVERSE Osteotom, gerade, 9mm breit, 18cm <i>CONVERSE osteotome, straight, 9mm wide, 18cm</i>
<b>LD-002-331</b>	CONVERSE Osteotom, gerade, 10mm breit, 18cm <i>CONVERSE osteotome, straight, 10mm wide, 18cm</i>
<b>LD-002-332</b>	CONVERSE Osteotom, gerade, 11mm breit, 18cm <i>CONVERSE osteotome, straight, 11mm wide, 18cm</i>
<b>LD-002-333</b>	CONVERSE Osteotom, gerade, 12mm breit, 18cm <i>CONVERSE osteotome, straight, 12mm wide, 18cm</i>
<b>LD-002-334</b>	CONVERSE Osteotom, gerade, 14mm breit, 18cm <i>CONVERSE osteotome, straight, 14mm wide, 18cm</i>

**LD-002-353**

**LD-002-335**  
bis / to  
**LD-002-337**

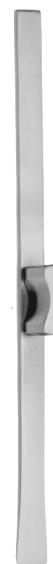
**LD-002-345**  
bis / to  
**LD-002-348**

**LD-002-340**  
bis / to  
**LD-002-343**

**LD-002-351 /  
LD-002-352**

Bestell-Nr. Ordering no.	Bezeichnung Description
<b>LD-002-335</b>	CONVERSE Osteotom, mit einseitigem Führungsdorn, gerade, 19cm <i>CONVERSE osteotome, with single guard, straight, 19cm</i>
<b>LD-002-336</b>	CONVERSE Osteotom, mit einseitigem Führungsdorn, links gebogen, 19cm <i>CONVERSE osteotome, with single guard, curved left, 19cm</i>
<b>LD-002-337</b>	CONVERSE Osteotom, mit einseitigem Führungsdorn, rechts gebogen, 19cm <i>CONVERSE osteotome, with single guard, curved right, 19cm</i>
<b>LD-002-340</b>	RUBIN Osteotom, mit Halteknopf, gerade, breite 10mm, 16cm <i>RUBIN osteotome, with stabilizer, straight, wide 10mm, 16cm</i>
<b>LD-002-341</b>	RUBIN Osteotom, mit Halteknopf, gerade, breite 12mm, 16cm <i>RUBIN osteotome, with stabilizer, straight, wide 12mm, 16cm</i>
<b>LD-002-342</b>	RUBIN Osteotom, mit Halteknopf, gerade, breite 14mm, 16cm <i>RUBIN osteotome, with stabilizer, straight, wide 14mm, 16cm</i>
<b>LD-002-343</b>	RUBIN Osteotom, mit Halteknopf, gerade, breite 16mm, 16cm <i>RUBIN osteotome, with stabilizer, straight, wide 16mm, 16cm</i>
<b>LD-002-345</b>	CINELLI Osteotom, mit doppelseitigem Führungsdorn, Breite 10mm, 16.5cm <i>CINELLI osteotome, double guard, width 10mm, 16.5cm</i>
<b>LD-002-346</b>	CINELLI Osteotom, mit doppelseitigem Führungsdorn, Breite 12mm, 16.5cm <i>CINELLI osteotome, double guard, width 12mm, 16.5cm</i>
<b>LD-002-347</b>	CINELLI Osteotom, mit doppelseitigem Führungsdorn, Breite 14mm, 16.5cm <i>CINELLI osteotome, double guard, width 14mm, 16.5cm</i>
<b>LD-002-348</b>	CINELLI Osteotom, mit doppelseitigem Führungsdorn, Breite 16mm, 16.5cm <i>CINELLI osteotome, double guard, width 16mm, 16.5cm</i>
<b>LD-002-351</b>	PARKES Osteotome, mit einseitiger Führung, 16cm <i>PARKES osteotome, single guard, 16cm</i>
<b>LD-002-352</b>	PARKES Osteotome, mit einseitiger Führung, schlankes Modell, 16cm <i>PARKES osteotome, single guard, slender model, 16cm</i>
<b>LD-002-353</b>	NEIVERT Osteotome, mit einseitiger Führung, gerade, 20.5cm <i>NEIVERT osteotome, single guard, straight, 20.5cm</i>



**LD-002-354 /  
LD-002-355**

**LD-002-359  
bis / to  
LD-002-361**

**LD-002-370**

**LD-002-371**

**LD-002-356  
bis / to  
LD-002-358**

**LD-002-372**

<b>Bestell-Nr. Ordering no.</b>	<b>Bezeichnung Description</b>
<b>LD-002-354</b>	ANDERSON-NEIVERT Osteotome, mit einseitiger Führung, links gebogen, 20.5cm <i>ANDERSON-NEIVERT osteotome, single guard, curved left, 20.5cm</i>
<b>LD-002-355</b>	ANDERSON-NEIVERT Osteotome, mit einseitiger Führung, rechts gebogen, 20.5cm <i>ANDERSON-NEIVERT osteotome, single guard, curved right, 20.5cm</i>
<b>LD-002-356</b>	SILVER Osteotome, mit einseitiger Führung, gerade, 18.5cm <i>SILVER osteotome, single guard, straight, 18.5cm</i>
<b>LD-002-357</b>	SILVER Osteotome, mit einseitiger Führung, links gebogen, 18.5cm <i>SILVER osteotome, single guard, curved left, 18.5cm</i>
<b>LD-002-358</b>	SILVER Osteotome, mit einseitiger Führung, rechts gebogen, 18.5cm <i>SILVER osteotome, single guard, curved right, 18.5cm</i>
<b>LD-002-359</b>	RISTOW Osteotome, mit einseitiger Führung, gerade, 20cm <i>RISTOW osteotome, single guard, straight, 20cm</i>
<b>LD-002-360</b>	RISTOW Osteotome, mit einseitiger Führung, links gebogen, 20cm <i>RISTOW osteotome, single guard, curved left, 20cm</i>
<b>LD-002-361</b>	RISTOW Osteotome, mit einseitiger Führung, rechts gebogen, 20cm <i>RISTOW osteotome, single guard, curved right, 20cm</i>
<b>LD-002-370</b>	RUBIN frontal Osteotom, 20cm <i>RUBIN frontal osteotome, 20cm</i>
<b>LD-002-371</b>	RUBIN lateral Osteotom, 20cm <i>RUBIN lateral osteotome, 20cm</i>
<b>LD-002-372</b>	QUISLING intranasal Brecher, 17.5cm <i>QUISLING intranasal crusher, 17.5cm</i>



LD-002-102



LD-002-100



ZA-001-487 /  
ZA-001-491



ZA-001-486 /  
ZA-004-364 /  
ZA-001-365

Bestell-Nr. Ordering no.	Bezeichnung Description
LD-002-100	COTTLE Metallhammer, 18cm COTTLE metal hammer, 18cm
LD-002-102	COTTLE Metallhammer mit auswechselbaren Kunststoff-Schlagflächen, 22.5 cm COTTLE metal hammer, interchangeable plastic discs, 22.5cm
LD-002-103	Kunststoff-Schlagflächen für LD-002-102, paarweise (ohne Abbildung) Interchangeable plastic discs for LD-002-102, pair (without illustration)
ZA-001-486	TROELTSCH Nasen-/Ohrpinzette, anatomisch fein, 12cm TROELTSCH nose/ear dressing forceps, fine, 12cm
ZA-004-364	TROELTSCH Nasenpinzette, kniegebogen, anatomisch, 15cm TROELTSCH nasal dressing forceps, angular, 15cm
ZA-004-365	TROELTSCH Nasenpinzette, kniegebogen, anatomisch, 17cm TROELTSCH nasal dressing forceps, angular, 17cm
ZA-001-487	LUCAE (JANSEN) Nasen-/Ohrpinzette, anatomisch, bajonettförmig, 14cm LUCAE (JANSEN) nose/ear dressing forceps, bayonet shape, 14cm
ZA-001-491	GRUENWALD (JANSEN) Nasenpinzette, bajonett, anatomisch, 20cm GRUENWALD (JANSEN) nasal dressing forceps, bayonet shape, 20cm



LR-002-004 /  
 LR-002-005



LC-030-003 /  
 LC-030-004



LC-030-001 /  
 LC-030-002

Bestell-Nr. Ordering no.	Bezeichnung Description
LC-030-001	HARTMANN Nasentamponzange, schlank, extra fein, NL 11cm <i>HARTMANN nasal tampon forceps, slender, extra delicate, WL 11cm</i>
LC-030-002	HARTMANN Nasentamponzange, schlank, NL 11cm <i>HARTMANN nasal tampon forceps, slender, WL 11cm</i>
LC-030-003	WESTMACOTT Nasentamponzange, 20cm <i>WESTMACOTT nasal tampon forceps, 20cm</i>
LC-030-004	WESTMACOTT Nasentamponzange, extra zart, 20cm <i>WESTMACOTT nasal tampon forceps, very delicate, 20cm</i>
LR-002-004	KRESSNER Muschelquetschzange, 3mm breit, 21cm <i>KRESSNER turbinate crushing forceps, 3mm wide, 21cm</i>
LR-002-005	KRESSNER Muschelquetschzange, 4mm breit, 21cm <i>KRESSNER turbinate crushing forceps, 4mm wide, 21cm</i>



**LC-003-001-SS**  
bis / to  
**LC-003-011-SS**



**LC-004-003-SS**  
bis / to  
**LC-004-005-SS**



**LC-003-021-SS**  
bis / to  
**LC-003-023-SS**



**LC-005-001-SS**  
bis / to  
**LC-005-004-SS**



**LC-004-001-SS /**  
**LC-004-002-SS**



**LC-003-001-SS**  
bis / to  
**LC-005-004-SS**

<b>Bestell-Nr.</b> <b>Ordering no.</b>	<b>Bezeichnung</b> <b>Description</b>
<b>LC-003-001-SS</b>	GRÜNWALD Conchotom, durchschneidend, Fig. 1 <i>GRÜNWALD nasal forceps, cutting through, fig. 1</i>
<b>LC-003-002-SS</b>	GRÜNWALD Conchotom, durchschneidend, Fig. 2 <i>GRÜNWALD nasal forceps, cutting through, fig. 2</i>
<b>LC-003-003-SS</b>	GRÜNWALD Conchotom, durchschneidend, Fig. 3 <i>GRÜNWALD nasal forceps, cutting through, fig. 3</i>
<b>LC-003-011-SS</b>	GRÜNWALD Conchotom, durchscheidend, 30°aufgebogen <i>GRÜNWALD nasal forceps, cutting through, 30° upward</i>
<b>LC-003-021-SS</b>	SCHMEDEEN Conchotom, durchschneidend, Fig. 1 <i>SCHMEDEEN nasal forceps, cutting through, fig. 1</i>
<b>LC-003-022-SS</b>	SCHMEDEEN Conchotom, durchschneidend, Fig. 2 <i>SCHMEDEEN nasal forceps, cutting through, fig. 2</i>
<b>LC-003-023-SS</b>	SCHMEDEEN Conchotom, durchschneidend, Fig. 3 <i>SCHMEDEEN nasal forceps, cutting through, fig. 3</i>
<b>LC-004-001-SS</b>	STRYCKEN Conchotom, Fig. 1, 1.0 x 15mm <i>STRYCKEN nasal cutting forceps, fig. 1, 1.0 x 15mm</i>
<b>LC-004-002-SS</b>	STRYCKEN Conchotom, Fig. 2, 1.5 x 15mm <i>STRYCKEN nasal cutting forceps, fig. 2, 1.5 x 15mm</i>
<b>LC-004-003-SS</b>	MORIYAMA Conchotom, durchschneidend, aufgebogen <i>MORIYAMA nasal cutting forceps, cutting through, upward curved</i>
<b>LC-004-004-SS</b>	MORIYAMA Conchotom, durchschneidend, Schaft aufgebogen <i>MORIYAMA nasal cutting forceps, cutting through, sheath upward curved</i>
<b>LC-004-005-SS</b>	MORIYAMA Conchotom, durchschneidend, besonders zart, gerade <i>MORIYAMA nasal cutting forceps, cutting through, delicate, straight</i>
<b>LC-005-001-SS</b>	HARTMANN Conchotom, Ø 5mm <i>HARTMANN nasal cutting forceps, Ø 5mm</i>
<b>LC-005-002-SS</b>	HARTMANN Conchotom, Ø 7mm <i>HARTMANN nasal cutting forceps, Ø 7mm</i>
<b>LC-005-003-SS</b>	HARTMANN Conchotom, Ø 9mm <i>HARTMANN nasal cutting forceps, Ø 9mm</i>
<b>LC-005-004-SS</b>	HARTMANN Conchotom, Ø 11mm <i>HARTMANN nasal cutting forceps, Ø 11mm</i>





**LC-001-001-SS**  
bis / to  
**LC-001-007-SS**



**LC-001-011-SS**  
bis / to  
**LC-001-017-SS**



**LC-001-022-SS**  
bis / to  
**LC-001-026-SS**



**LC-001-001-SS**  
bis / to  
**LC-001-026-SS**

Bestell-Nr. Ordering no.	Bezeichnung Description
<b>LC-001-001-SS</b>	WEIL-BLAKESLEY Nasenzange, gerade, 2.5mm WEIL-BLAKESLEY nasal forceps, straight, 2.5mm
<b>LC-001-002-SS</b>	WEIL-BLAKESLEY Nasenzange, gerade, 3.0mm WEIL-BLAKESLEY nasal forceps, straight, 3.0mm
<b>LC-001-003-SS</b>	WEIL-BLAKESLEY Nasenzange, gerade, 3.6mm WEIL-BLAKESLEY nasal forceps, straight, 3.6mm
<b>LC-001-004-SS</b>	WEIL-BLAKESLEY Nasenzange, gerade, 4.2mm WEIL-BLAKESLEY nasal forceps, straight, 4.2mm
<b>LC-001-005-SS</b>	WEIL-BLAKESLEY Nasenzange, gerade, 4.8mm WEIL-BLAKESLEY nasal forceps, straight, 4.8mm
<b>LC-001-006-SS</b>	WEIL-BLAKESLEY Nasenzange, gerade, 5.3mm WEIL-BLAKESLEY nasal forceps, straight, 5.3mm
<b>LC-001-007-SS</b>	WEIL-BLAKESLEY Nasenzange, gerade, 6.3mm WEIL-BLAKESLEY nasal forceps, straight, 6.3mm
<b>LC-001-011-SS</b>	WEIL-BLAKESLEY Nasenzange, 45° aufgebogen, 2.5mm WEIL-BLAKESLEY nasal forceps, 45° upward, 2.5mm
<b>LC-001-012-SS</b>	WEIL-BLAKESLEY Nasenzange, 45° aufgebogen, 3.0mm WEIL-BLAKESLEY nasal forceps, 45° upward, 3.0mm
<b>LC-001-013-SS</b>	WEIL-BLAKESLEY Nasenzange, 45° aufgebogen, 3.6mm WEIL-BLAKESLEY nasal forceps, 45° upward, 3.6mm
<b>LC-001-014-SS</b>	WEIL-BLAKESLEY Nasenzange, 45° aufgebogen, 4.2mm WEIL-BLAKESLEY nasal forceps, 45° upward, 4.2mm
<b>LC-001-015-SS</b>	WEIL-BLAKESLEY Nasenzange, 45° aufgebogen, 4.8mm WEIL-BLAKESLEY nasal forceps, 45° upward, 4.8mm
<b>LC-001-016-SS</b>	WEIL-BLAKESLEY Nasenzange, 45° aufgebogen, 5.3mm WEIL-BLAKESLEY nasal forceps, 45° upward, 5.3mm
<b>LC-001-017-SS</b>	WEIL-BLAKESLEY Nasenzange, 45° aufgebogen, 6.3mm WEIL-BLAKESLEY nasal forceps, 45° upward, 6.3mm
<b>LC-001-022-SS</b>	WEIL-BLAKESLEY Nasenzange, 90° aufgebogen, 3.0mm WEIL-BLAKESLEY nasal forceps, 90° upward, 3.0mm
<b>LC-001-023-SS</b>	WEIL-BLAKESLEY Nasenzange, 90° aufgebogen, 3.6mm WEIL-BLAKESLEY nasal forceps, 90° upward, 3.6mm
<b>LC-001-024-SS</b>	WEIL-BLAKESLEY Nasenzange, 90° aufgebogen, 4.2mm WEIL-BLAKESLEY nasal forceps, 90° upward, 4.2mm
<b>LC-001-025-SS</b>	WEIL-BLAKESLEY Nasenzange, 90° aufgebogen, 5.0mm WEIL-BLAKESLEY nasal forceps, 90° upward, 5.0mm
<b>LC-001-026-SS</b>	WEIL-BLAKESLEY Nasenzange, langes Maul, 90° aufgebogen, 3.6mm WEIL-BLAKESLEY nasal forceps, long jaw, 90° upward, 3.6mm



**LC-002-001-SS /  
 LC-002-003-SS /  
 LC-002-005-SS**



**LC-002-111-SS  
 bis / to  
 LC-002-115-SS**



**LC-002-002-SS /  
 LC-002-004-SS /  
 LC-002-006-SS**



**LC-002-122-SS  
 bis / to  
 LC-002-124-SS**



**LC-002-001-SS  
 bis / to  
 LC-002-124-SS**

<b>Bestell-Nr. Ordering no.</b>	<b>Bezeichnung Description</b>
<b>LC-002-001-SS</b>	TAKAHASHI Nasenzange 4 x 10mm, gerade <i>TAKAHASHI nasal forceps 4 x 10mm, straight</i>
<b>LC-002-003-SS</b>	TAKAHASHI Nasenzange 2.5 x 8mm, gerade <i>TAKAHASHI nasal forceps 2.5 x 8mm, straight</i>
<b>LC-002-005-SS</b>	TAKAHASHI Nasenzange 3 x 8mm, gerade <i>TAKAHASHI nasal forceps 3 x 8mm, straight</i>
<b>LC-002-002-SS</b>	TAKAHASHI Nasenzange 4 x 10mm, 45° aufgebogen <i>TAKAHASHI nasal forceps 4 x 10mm, 45° upward</i>
<b>LC-002-004-SS</b>	TAKAHASHI Nasenzange 2.5 x 8mm, 45° aufgebogen <i>TAKAHASHI nasal forceps 2.5 x 8mm, 45° upward</i>
<b>LC-002-006-SS</b>	TAKAHASHI Nasenzange 3 x 8mm, 45° aufgebogen <i>TAKAHASHI nasal forceps 3 x 8mm, 45° upward</i>
<b>LC-002-111-SS</b>	BLAKESLEY-WILDE Nasenzange, 45° aufgebogen, 2.5mm, Größe 0, AL 11cm <i>BLAKESLEY-WILDE nasal forceps, 45° upward, 2.5mm, size 0, WL 11cm</i>
<b>LC-002-112-SS</b>	BLAKESLEY-WILDE Nasenzange, 45° aufgebogen, 3.0mm, Größe 1, AL 11cm <i>BLAKESLEY-WILDE nasal forceps, 45° upward, 3.0mm, size 1, WL 11cm</i>
<b>LC-002-113-SS</b>	BLAKESLEY-WILDE Nasenzange, 45° aufgebogen, 3.6mm, Größe 2, AL 11cm <i>BLAKESLEY-WILDE nasal forceps, 45° upward, 3.6mm, size 2, WL 11cm</i>
<b>LC-002-114-SS</b>	BLAKESLEY-WILDE Nasenzange, 45° aufgebogen, 4.0mm, Größe 3, AL 11cm <i>BLAKESLEY-WILDE nasal forceps, 45° upward, 4.0mm, size 3, WL 11cm</i>
<b>LC-002-115-SS</b>	BLAKESLEY-WILDE Nasenzange, 45° aufgebogen, 5.0mm, Größe 4, AL 11cm <i>BLAKESLEY-WILDE nasal forceps, 45° upward, 5.0mm, size 4, WL 11cm</i>
<b>LC-002-122-SS</b>	BLAKESLEY-WILDE Nasenzange, 90° aufgebogen, 3.0mm, Größe 1, AL 11cm <i>BLAKESLEY-WILDE nasal forceps, 90° upward, 3.0mm, size 1, WL 11cm</i>
<b>LC-002-123-SS</b>	BLAKESLEY-WILDE Nasenzange, 90° aufgebogen, 3.6mm, Größe 2, AL 11cm <i>BLAKESLEY-WILDE nasal forceps, 90° upward, 3.6mm, size 2, WL 11cm</i>
<b>LC-002-124-SS</b>	BLAKESLEY-WILDE Nasenzange, 90° aufgebogen, 4.0mm, Größe 3, AL 11cm <i>BLAKESLEY-WILDE nasal forceps, 90° upward, 4.0mm, size 3, WL 11cm</i>



**LC-004-005**  
bis / to  
**LC-004-007**



**LC-018-002-SS**



**LC-020-017 /**  
**LC-020-019**



**LC-004-005**  
bis / to  
**LC-020-019**

Bestell-Nr. Ordering no.	Bezeichnung Description
<b>LC-004-005</b>	MORIYAMA Universal Nasenzange, ovaler Löffel, gerade, 13cm <i>MORIYAMA universal nasal cutting forceps, oval cups, straight, 13cm</i>
<b>LC-004-006</b>	MORIYAMA Universal Nasenzange, ovaler Löffel, aufgebogen, 13cm <i>MORIYAMA universal nasal cutting forceps, oval cups, upward, 13cm</i>
<b>LC-004-007</b>	MORIYAMA Universal Nasenzange, ovaler Löffel, Schaft aufgebogen, 13cm <i>MORIYAMA universal nasal cutting forceps, oval cups, sheath upward, 13cm</i>
<b>LC-018-002-SS</b>	STRÜMPEL-VOSS Nasenzange, 45° aufgebogen, 2.5mm <i>STRÜMPEL nasal cutting forceps, 45° upward, 2.5mm</i>
<b>LC-020-017</b>	WATSON-WILLIAMS Nasenzange, gezahnt, gerade, NL 11cm <i>WATSON WILLIAMS nasal cutting forceps, serrated, straight, WL 11cm</i>
<b>LC-020-019</b>	WATSON-WILLIAMS Nasenzange, 45° aufgebogen, NL 11cm <i>WATSON WILLIAMS nasal cutting forceps, 45° upward, WL 11cm</i>

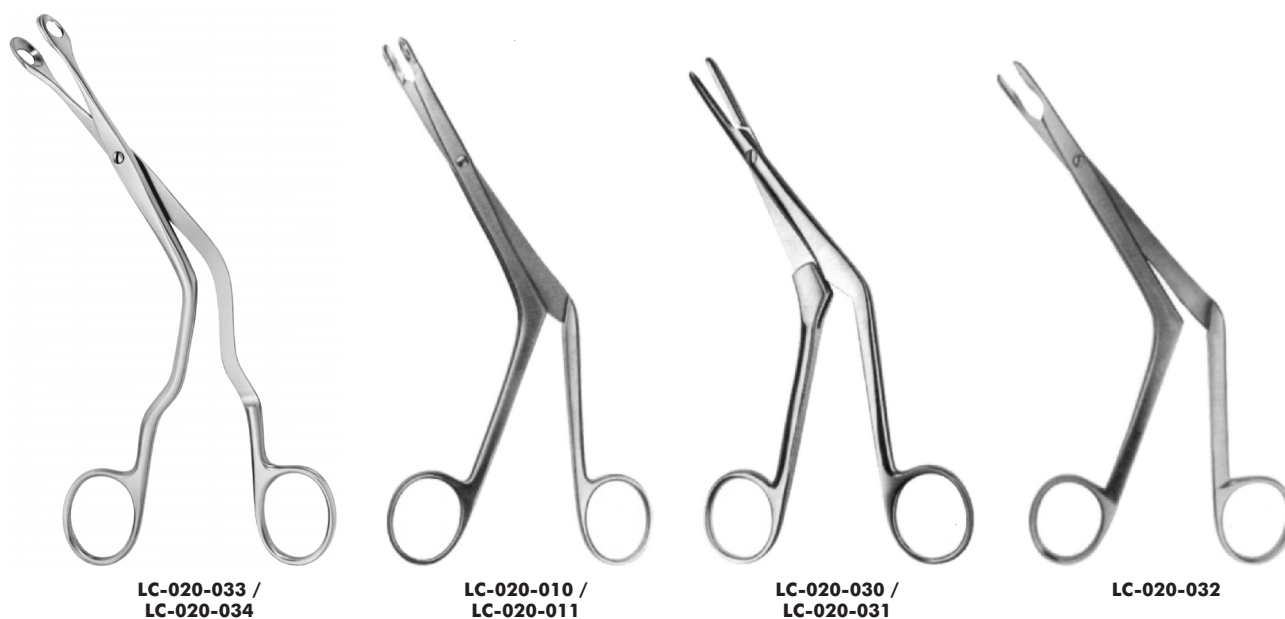

Bestell-Nr. Ordering no.	Bezeichnung Description
LC-020-010	BRÜNING Nasenzange, Fig. 1 <i>BRÜNING nasal cutting forceps, fig. 1</i>
LC-020-011	BRÜNING Nasenzange, Fig. 2 <i>BRÜNING nasal cutting forceps, fig. 2</i>
LC-020-030	CRAIG Septumzange, scharfer Löffel, NL 10cm, 18cm <i>CRAIG septum forceps, sharp spoon, WL 10cm, 18cm</i>
LC-020-031	CRAIG-DOMNICK Septumzange gebogen, scharfer Löffel, NL 10cm, 18cm <i>CRAIG-DOMNICK septum forceps curved, sharp spoon, WL 10cm, 18cm</i>
LC-020-032	KNIGHT Septumzange, NL 11cm <i>KNIGHT septum forceps, WL 11cm</i>
LC-020-033	LUC Septumzange, Fig. 1, NL 20.5cm <i>LUC septum forceps, fig. 1, WL 20.5cm</i>
LC-020-034	LUC Septumzange, Fig. 2, NL 20.5cm <i>LUC septum forceps, fig. 2, WL 20.5cm</i>



**LD-040-001**  
bis / to  
**LD-040-006**



**ZA-003-425**  
bis / to  
**ZA-003-427**

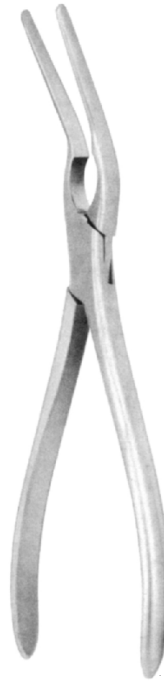

**ZA-003-424**



**LR-002-006**

Bestell-Nr. Ordering no.	Bezeichnung Description
<b>LD-040-001</b>	ROWE Repositionszange, rechts, klein für Säuglinge, 22.5cm <i>ROWE disimpaction forceps, right, small for babies, 22.5cm</i>
<b>LD-040-002</b>	ROWE Repositionszange, rechts, mittel für Kinder, 23.5cm <i>ROWE disimpaction forceps, right, medium for children, 23.5cm</i>
<b>LD-040-003</b>	ROWE Repositionszange, rechts, groß für Erwachsene, 24cm <i>ROWE disimpaction forceps, right, large for adults, 24cm</i>
<b>LD-040-004</b>	ROWE Repositionszange, links, klein für Säuglinge, 22.5cm <i>ROWE disimpaction forceps, left, small for babies, 22.5cm</i>
<b>LD-040-005</b>	ROWE Repositionszange, links, mittel für Kinder, 23.5cm <i>ROWE disimpaction forceps, left, medium for children, 23.5cm</i>
<b>LD-040-006</b>	ROWE Repositionszange, links, groß für Erwachsene, 24cm <i>ROWE disimpaction forceps, left, large for adults, 24cm</i>
<b>LR-002-006</b>	COTTLE-WALSHAM Septumrichtzange, zerlegbar, 21.5cm <i>COTTLE-WALSHAM septum straightening forceps, detachable, 21.5cm</i>
<b>ZA-003-424</b>	ASH Septumrichtzange, 22cm <i>ASH septum straightening forceps, 22cm</i>
<b>ZA-003-425</b>	COTTLE-WALSHAM Septumrichtzange, gerade, 23cm <i>COTTLE-WALSHAM septum straightening forceps, straight, 23cm</i>
<b>ZA-003-426</b>	COTTLE-WALSHAM Septumrichtzange, links, 23cm <i>COTTLE-WALSHAM septum straightening forceps, left, 23cm</i>
<b>ZA-003-427</b>	COTTLE-WALSHAM Septumrichtzange, rechts, 23cm <i>COTTLE-WALSHAM septum straightening forceps, right, 23cm</i>



**LC-020-015**



**LC-020-016**



**LC-020-035 /  
LC-020-036**

<b>Bestell-Nr. Ordering no.</b>	<b>Bezeichnung Description</b>
<b>LC-020-015</b>	MIDDLETON-JANSEN Nasenzange durchschneidend <i>MIDDLETON-JANSEN nasal cutting forceps cutting through</i>
<b>LC-020-016</b>	MIDDLETON-JANSEN Nasenzange durchschneidend, gross <i>MIDDLETON-JANSEN nasal cutting forceps cutting through, large</i>
<b>LC-020-035</b>	RUBIN Knorpelquetschzange, gerade, doppelgeweglich, 22cm <i>RUBIN septum morcelizer, straight, double action, 22cm</i>
<b>LC-020-036</b>	RUBIN Knorpelquetschzange, gebogen, doppelgeweglich, 22cm <i>RUBIN septum morcelizer, curved, double action, 22cm</i>



LR-001-001



LR-002-001 /  
 LR-002-002



LR-002-003

Bestell-Nr. Ordering no.	Bezeichnung Description
LR-001-001	COTTLE-KAZANJIAN Knochensplitterzange, gerade, 18.5cm COTTLE-KAZANJIAN bone cutting forceps, straight, 18.5cm
LR-002-001	RUSKIN-ROWLAND Nasenzange mit Doppelgelenk, gerade, 18cm RUSKIN-ROWLAND nasal rongeur, double action, straight, 18cm
LR-002-002	RUSKIN-ROWLAND Nasenzange mit Doppelgelenk, aufgebogen, 18cm RUSKIN-ROWLAND nasal rongeur, double action, up curved, 18cm
LR-002-003	MEYER Knochen- und Knorpel mit Doppelgelenk, Schneiden gebogen, 35mm, 18cm MEYER nasal rongeur, double action, blades curved, 35mm, 18cm





**LC-007-004**  
bis / to  
**LC-007-085**



**ZA-001-708**



**LC-007-005**  
bis / to  
**LC-007-017**

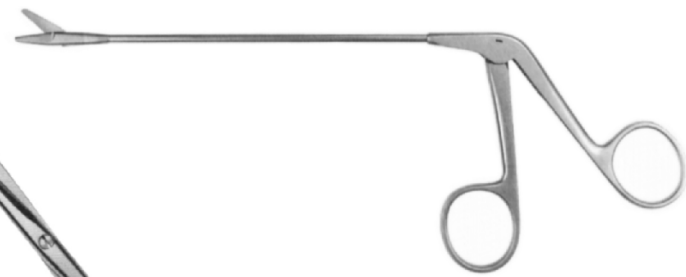

**LC-007-001**  
bis / to  
**LC-007-003**

Bestell-Nr. Ordering no.	Bezeichnung Description
<b>LC-007-001</b>	Nasenschere für Concha, gezahnte Schneiden, gerade <i>Nasal scissors, serrated blades, straight</i>
<b>LC-007-002</b>	Nasenschere für Concha, gezahnte Schneiden, links gebogen <i>Nasal scissors, serrated blades, left curved</i>
<b>LC-007-003</b>	Nasenschere für Concha, gezahnte Schneiden, rechts gebogen <i>Nasal scissors, serrated blades, right curved</i>
<b>LC-007-004</b>	FOMON gebogene Schere, gezahnte Schneiden, fein, AL 6.5cm <i>FOMON angular scissors, serrated blades, delicate, WL 6.5cm</i>
<b>LC-007-084</b>	FOMON gebogene Schere, glatte Schneiden, fein, AL 6.5cm <i>FOMON angular scissors, smooth blades, delicate, WL 6.5cm</i>
<b>LC-007-085</b>	FOMON gebogene Schere, TC-Einlage, fein, AL 6.5cm <i>FOMON angular scissors, TC-insert, delicate, WL 6.5cm</i>
<b>LC-007-005</b>	HEYMANN Nasenschere, SC, AL 9.5cm <i>HEYMANN nasal scissors, SC, WL 9.5cm</i>
<b>LC-007-006</b>	HEYMANN Nasenschere, AL 9cm <i>HEYMANN nasal scissors, WL 9cm</i>
<b>LC-007-007</b>	HEYMANN Nasenschere, AL 9.5cm <i>HEYMANN nasal scissors, WL 9.5cm</i>
<b>LC-007-008</b>	HEYMANN Nasenschere, gezahnt, AL 9.5cm <i>HEYMANN nasal scissors, serrated, WL 9.5cm</i>
<b>LC-007-009</b>	HEYMANN Nasenschere, AL 11cm <i>HEYMANN nasal scissors, WL 11cm</i>
<b>LC-007-016</b>	HEYMANN Nasenschere, links gebogen, AL 9.5cm <i>HEYMANN nasal scissors, curved left, WL 9.5cm</i>
<b>LC-007-017</b>	HEYMANN Nasenschere, rechts gebogen, AL 9.5cm <i>HEYMANN nasal scissors, curved right, WL 9.5cm</i>
<b>ZA-001-708</b>	COTTLE Nasenschere, stumpf, 16cm <i>COTTLE nasal scissors, blunt, 16cm</i>



Bestell-Nr. Ordering no.	Bezeichnung Description
LC-007-021	BECKER Septumschere, mit Doppelgelenk, gezahnt, AL 9.5 cm <i>BECKER nasal scissors, double action, serrated, WL 9.5cm</i>
LC-007-080	FOMON-COTTLE Nasenflügelschere, stark gebogen, 12cm <i>FOMON-COTTLE lower lateral scissors, strong curved, 12cm</i>
LC-007-081	FOMON Schere, Doppelblatt, gebogen, 12cm <i>FOMON scissors, double blade, curved, 12cm</i>
LC-007-082	COTTLE Nasenschere, abgebogen, glatte Schneiden, 16cm <i>COTTLE nasal scissor, angled, smooth blades, 16cm</i>
LC-007-083	COTTLE Nasenschere, abgebogen, TC-Einlage, 16cm <i>COTTLE nasal scissor, angled, TC-insert, 16cm</i>
LC-007-086	COTTLE Nasenschere, abgebogen, gezahnte Schneiden, 16cm <i>COTTLE nasal scissor, angled, serrated blades, 16cm</i>
LC-020-037	CAPLAN Nasenschere mit Doppelgelenk, abgewinkelt, Schneiden gezahnt, 22cm <i>CAPLAN nasal scissors, double action, angled, serrated blades, 22cm</i>
LC-020-038	CAPLAN Nasenschere mit Doppelgelenk, gerade, Schneiden gezahnt, 22cm <i>CAPLAN nasal scissors, double action, straight, serrated blades, 22cm</i>



**LI-001-016/  
LI-001-017**

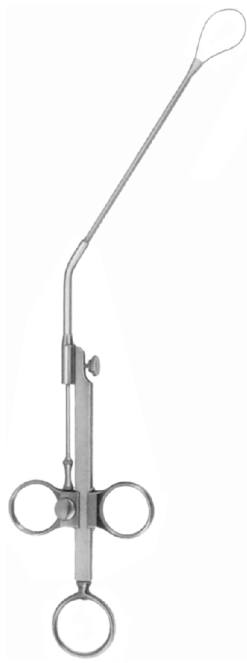

**LI-001-014 /  
LI-001-015**



**LI-001-011  
bis / to  
LI-001-013**

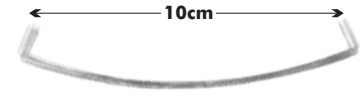

**LI-001-110  
bis / to  
LI-001-112**

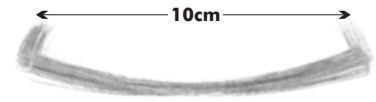

**LI-001-113  
bis / to  
LI-001-115**

Bestell-Nr. Ordering no.	Bezeichnung Description
<b>LI-001-011</b>	KRAUSE Nasenpolypenschnürer, 26cm <i>KRAUSE nasal polypus snare, 26cm</i>
<b>LI-001-012</b>	Aufsatz <i>Cannula</i>
<b>LI-001-013</b>	Styilet <i>Styilet</i>
<b>LI-001-014</b>	KRAUSE-VOSS Nasenpolypenschnürer, 26cm <i>KRAUSE-VOSS nasal polypus snare, 26cm</i>
<b>LI-001-015</b>	Aufsatz <i>Cannula</i>
<b>LI-001-016</b>	LANGE-WILDE Nasenpolypenschnürer, 26cm <i>LANGE-WILDE nasal polypus snare, 26cm</i>
<b>LI-001-017</b>	Styilet <i>Styilet</i>
<b>LI-001-110</b>	Schnürerdrähte für Nasenpolypenschnürer, geformt, 0.25mm stark, 12 Stück <i>Snare wires for nasal polyp snare, shaped, 0.25mm, 12 pieces</i>
<b>LI-001-111</b>	Schnürerdrähte für Nasenpolypenschnürer, geformt, 0.3mm stark, 12 Stück <i>Snare wires for nasal polyp snare, shaped, 0.3mm, 12 pieces</i>
<b>LI-001-112</b>	Schnürerdrähte für Nasenpolypenschnürer, geformt, 0.35mm stark, 12 Stück <i>Snare wires for nasal polyp snare, shaped, 0.35mm, 12 pieces</i>
<b>LI-001-113</b>	Schnürerdrähte für Nasenpolypenschnürer, geformt, 0.25mm stark, 100 Stück <i>Snare wires for nasal polyp snare, shaped, 0.25mm, 100 pieces</i>
<b>LI-001-114</b>	Schnürerdrähte für Nasenpolypenschnürer, geformt, 0.3mm stark, 100 Stück <i>Snare wires for nasal polyp snare, shaped, 0.3mm, 100 pieces</i>
<b>LI-001-115</b>	Schnürerdrähte für Nasenpolypenschnürer, geformt, 0.35mm stark, 100 Stück <i>Snare wires for nasal polyp snare, shaped, 0.35mm, 100 pieces</i>





# STEMA

Medizintechnik GmbH

## SINUSKOPIE

## SINUSCOPY

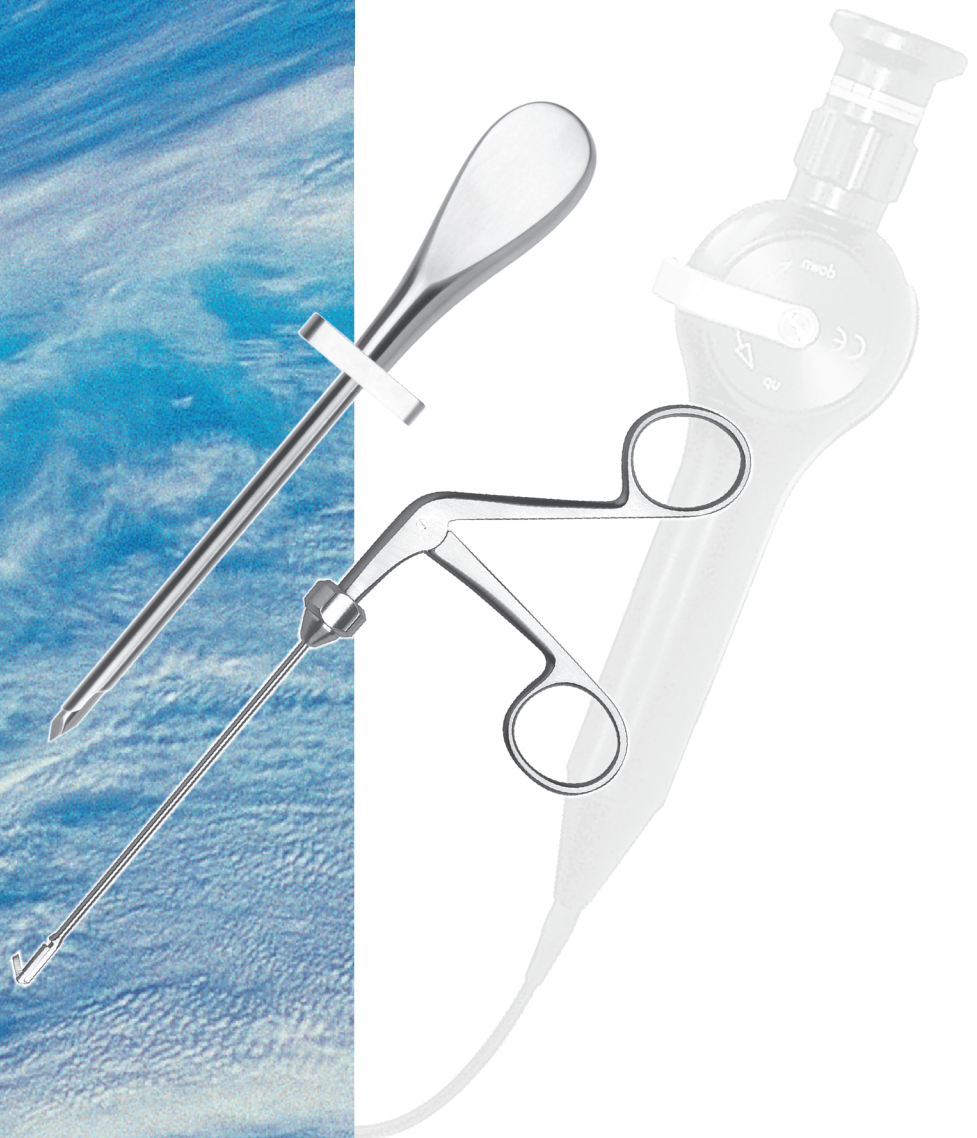





	Bestell-Nr. Ordering no.	Durchmesser Diameter	Blickwinkel Viewing angle	Nutzlänge Working length
<b>1.9</b>	LA-004-001	1.9mm	0°	69mm
	LA-004-002	1.9mm	30°	69mm
	LA-005-001	1.9mm	0°	102mm
	LA-005-002	1.9mm	30°	102mm
<b>2.4</b>	LA-006-001	2.4mm	0°	110mm
	LA-006-002	2.4mm	30°	110mm
	LA-007-001	2.4mm	0°	123mm
	LA-007-002	2.4mm	30°	123mm
<b>2.7</b>	LA-000-001	2.7mm	0°	41mm
	LA-000-002	2.7mm	30°	41mm
	LA-003-001	2.7mm	0°	110mm
	LA-003-002	2.7mm	30°	110mm
	LA-003-003	2.7mm	70°	110mm
	LA-001-001	2.7mm	0°	175mm
	LA-001-002	2.7mm	30°	175mm
	LA-001-003	2.7mm	70°	175mm
	LA-001-004	2.7mm	0°	187.5mm
	LA-001-005	2.7mm	30°	187.5mm
	LA-001-006	2.7mm	70°	187.5mm
<b>3.0</b>	LA-000-005	3.0mm	0°	41mm



**4.0**

Bestell-Nr. Ordering no.	Durchmesser Diameter	Blickwinkel Viewing angle	Nutzlänge Working length
LA-000-003	4.0mm	0°	50mm
LA-000-004	4.0mm	30°	50mm
LA-002-005	4.0mm	0°	110mm
LA-002-006	4.0mm	30°	110mm
LA-002-008	4.0mm	45°	110mm
LA-002-007	4.0mm	70°	110mm
LA-002-009	4.0mm	0°	142mm
LA-002-010	4.0mm	30°	142mm
LA-002-012	4.0mm	45°	142mm
LA-002-011	4.0mm	70°	142mm
LA-002-001	4.0mm	0°	175mm
LA-002-002	4.0mm	30°	175mm
LA-002-004	4.0mm	45°	175mm
LA-002-003	4.0mm	70°	175mm
LA-002-013	4.0mm	0°	187.5mm
LA-002-014	4.0mm	30°	187.5mm
LA-002-016	4.0mm	45°	187.5mm
LA-002-015	4.0mm	70°	187.5mm



Bestell-Nr. Ordering no.	Bezeichnung Description
ES-008-001	Anti-Beschlagmittel, 7ml, 20 Stück pro Box Anti-Fog solution, 7ml, 20 pieces each box





Bestell-Nr. Ordering no.	Bezeichnung Description	Merkmale	Features
<b>LA-010-000</b>	Flexibles Naso-Pharyngoskop mit ETO Ventil, Ø 3.2mm x 300mm <i>Flexible Nose-Pharyngoscope with ETO-valve, Ø 3.2mm x 300mm</i>	Konventionelles Bildbündel, 12.000 Pixel mit 2-facher Abwinkelung, Einhandbedienung, einlegbar und gassterilisierbar  Nutzlänge: 300mm Durchmesser: 3.2mm Abwinkelung: auf 125° ab 125°  Länge abw. Spitze: 25mm Blickrichtung: 0° Blickwinkel: Weitwinkel Tiefenschärfe: 3mm bis	Conventional image guide system, 12.000 pixels, 2-way deflection, one hand operation, soakable and designed for gas sterilization  Working length: 300mm Diameter: 3.2mm Deflection: up 125° down 125°  Length of mov. tip: 25mm Direction of view: 0° Field of view: wide angle Depth of focus: 3mm to
<b>LA-010-001</b>	Flexibles Naso-Pharyngoskop mit ETO Ventil, Ø 3.8mm x 300mm <i>Flexible Nose-Pharyngoscope with ETO-valve, Ø 3.8mm x 300mm</i>	Konventionelles Bildbündel, 12.000 Pixel mit 2-facher Abwinkelung, Einhandbedienung, einlegbar und gassterilisierbar  Nutzlänge: 300mm Durchmesser: 3.8mm Abwinkelung: auf 125° ab 125°  Länge abw. Spitze: 25mm Blickrichtung: 0° Blickwinkel: Weitwinkel Tiefenschärfe: 3mm bis	Conventional image guide system, 12.000 pixels, 2-way deflection, one hand operation, soakable and designed for gas sterilization  Working length: 300mm Diameter: 3.8mm Deflection: up 125° down 125°  Length of mov. tip: 25mm Direction of view: 0° Field of view: wide angle Depth of focus: 3mm to
<b>LA-010-003</b>	Flexibles Naso-Pharyngoskop mit Arbeitskanal Ø 1.4mm <i>Flexible Nose-Pharyngoscope with working channel Ø 1.4mm</i>	Mit Arbeitskanal  Blickrichtung: 0° Blickwinkel: 85° Tiefenschärfe: 3mm bis Flexibl. Arbeitsende: 400mm Längenmark. Ø: 4.3mm Abwinkelung: auf 140° ab 140°  Arbeitskanal Ø: 1.4mm Instrumente: L: 750mm Ø: 1.0mm	With working channel  Direction of view: 0° Field of view: 85° Depth of focus: 3mm to Flexible working end: 400mm Linear markings Ø: 4.3mm Deflection: up 140° down 140°  Working channel Ø: 1.4mm Instruments: L: 750mm Ø: 1.0mm



**LB-002-011**  
bis / to  
**LB-002-015**



**LB-005-001**  
bis / to  
**LB-005-003**



**LB-002-001**  
bis / to  
**LB-002-005**

Bestell-Nr. Ordering no.	Bezeichnung Description
<b>LB-002-001</b>	Universal Sinuskopieschaft, Ø 3.5mm, AL 17cm <i>Universal sinuscopy sheath, Ø 3.5mm, WL 17cm</i>
<b>LB-002-002</b>	Universal Sinuskopieschaft, Ø 5mm, AL 17cm <i>Universal sinuscopy sheath, Ø 5mm, WL 17cm</i>
<b>LB-002-003</b>	Universal Sinuskopieschaft, Ø 5mm, für 30° Sinuskope, AL 17cm <i>Universal sinuscopy sheath, Ø 5mm, for 30° sinusscopes, WL 17cm</i>
<b>LB-002-004</b>	Universal Sinuskopieschaft, Ø 5mm, AL 8.5cm <i>Universal sinuscopy sheath, Ø 5mm, WL 8.5cm</i>
<b>LB-002-005</b>	Universal Sinuskopieschaft, Ø 5mm, für 30° Sinuskope, AL 8.5cm <i>Universal sinuscopy sheath, Ø 5mm, for 30° sinusscopes, WL 8.5cm</i>
<b>LB-005-001</b>	Ø 3.5mm Trokar dreikant, 17cm <i>Ø 3.5mm trocar pyramidal, 17cm</i>
<b>LB-005-002</b>	Ø 5mm Trokar dreikant, 17cm <i>Ø 5mm trocar pyramidal, 17cm</i>
<b>LB-005-003</b>	Ø 5mm Trokar dreikant, 8.5cm <i>Ø 5mm trocar pyramidal, 8.5cm</i>
<b>LB-002-011</b>	Universal Sinuskopieschaft, Ø 3.5mm, mit dreikant Trokar, AL 17cm <i>Universal sinuscopy sheath, Ø 3.5mm, with pyramdial trocar, WL 17cm</i>
<b>LB-002-012</b>	Universal Sinuskopieschaft, Ø 5mm, mit dreikant Trokar, AL 17cm <i>Universal sinuscopy sheath, Ø 5mm, with pyramdial trocar, WL 17cm</i>
<b>LB-002-013</b>	Universal Sinuskopieschaft, Ø 5mm, mit dreikant Trokar, für 30° Sinuskope, AL 17cm <i>Universal sinuscopy sheath, Ø 5mm, with pyramdial trocar, for 30° sinusscopes, WL 17cm</i>
<b>LB-002-014</b>	Universal Sinuskopieschaft, Ø 5mm, mit dreikant Trokar, AL 8.5cm <i>Universal sinuscopy sheath, Ø 5mm, with pyramdial trocar, WL 8.5cm</i>
<b>LB-002-015</b>	Universal Sinuskopieschaft, Ø 5mm, mit dreikant Trokar, für 30° Sinuskope, AL 8.5cm <i>Universal sinuscopy sheath, Ø 5mm, with pyramdial trocar, for 30° sinusscopes, WL 8.5cm</i>



LB-002-021



LB-002-022  
bis / to  
LB-002-024



LB-002-026



LB-002-020 /  
LB-002-025

Bestell-Nr. Ordering no.	Bezeichnung Description
LB-002-020	LICHTWITZ Kieferhöhlentrokar, Ø 2mm, NL 10cm LICHTWITZ antrum trocar, Ø 2mm, WL 10cm
LB-002-025	LICHTWITZ Kieferhöhlentrokarnadel, Ø 2mm, NL 10cm LICHTWITZ antrum trocar needle, Ø 2mm, WL 10cm
LB-002-021	COAKLEY Kieferhöhlentrokar, gebogen, Ø 3mm, NL 14cm COAKLEY antrum trocar, curved, Ø 3mm, WL 14cm
LB-002-022	PIERCE Kieferhöhlentrokar, gebogen, Ø 3mm, NL 8.5cm PIERCE antrum trocar, curved, Ø 3mm, WL 8.5cm
LB-002-023	PIERCE Kieferhöhlentrokar, gebogen, Ø 4mm, NL 8.5cm PIERCE antrum trocar, curved, Ø 4mm, WL 8.5cm
LB-002-024	PIERCE Kieferhöhlentrokar, gebogen, Ø 5mm, NL 8.5cm PIERCE antrum trocar, curved, Ø 5mm, WL 8.5cm
LB-002-026	VANALEYA Kieferhöhlentrokar, S-förmig, Ø 1.8mm, NL 11.5cm VANALEYA antrum trocar, S-shape, Ø 1.8mm, WL 11.5cm

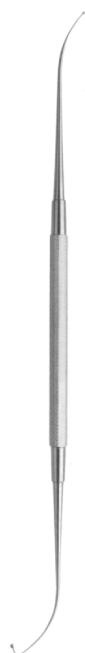

LD-001-071

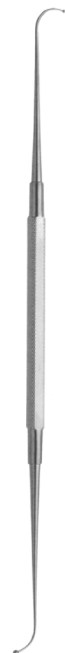

LD-001-070



LD-001-080

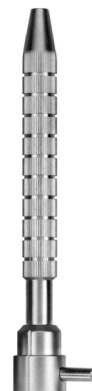

LB-001-001



LB-001-002

Bestell-Nr. Ordering no.	Bezeichnung Description
LB-001-001	STAMMBERGER Griff, flach, für Sinuskope, 11cm <i>STAMMBERGER handle, flat, for sinusscopes, 11cm</i>
LB-001-002	STAMMBERGER Griff, rund, für Sinuskope, 11cm <i>STAMMBERGER handle, round, for sinusscopes, 11cm</i>
LD-001-070	Maxillary Ostium Sonde, beidseitig, kugelförmige Enden Ø 1.2mm und Ø 2.0mm, 20cm <i>Maxillary sinus ostium seeker, double-ended, ball size Ø 1.2mm and Ø 2.0mm, 20cm</i>
LD-001-071	KUHN-BOGLER Frontal Ostium Sonde, beidseitig, gebogen, einseitig rechtwinkliger Haken, 20cm <i>KUHN-BOGLER frontal ostium seeker, double-ended, curved, right angled hook at one end, 20cm</i>
LD-001-080	HARTMANN Nasensonde, gebogen, 13.5cm <i>HARTMANN nasal probe, curved, 13.5cm</i>



**LD-001-027 /  
LD-001-028**



**LD-001-191**



**LD-001-014  
bis / to  
LD-001-019**



**LD-001-038**



**LD-001-020  
bis / to  
LD-001-026**

<b>Bestell-Nr. Ordering no.</b>	<b>Bezeichnung Description</b>
<b>LD-001-014</b>	Antrumkürette, oval, Fig. 1, 20cm <i>Antrum curette, oval, fig. 1, 20cm</i>
<b>LD-001-015</b>	Antrumkürette, oval, Fig. 2, 20cm <i>Antrum curette, oval, fig. 2, 20cm</i>
<b>LD-001-016</b>	Antrumkürette, oval, Fig. 3, 20cm <i>Antrum curette, oval, fig. 3, 20cm</i>
<b>LD-001-017</b>	Antrumkürette, rund, 20cm <i>Antrum curette, round, 20cm</i>
<b>LD-001-018</b>	Antrumkürette, längsoval, 20cm <i>Antrum curette, small oval, 20cm</i>
<b>LD-001-019</b>	Antrumkürette, längsoval, 45°, 20cm <i>Antrum curette, small oval, 45°, 20cm</i>
<b>LD-001-020</b>	COAKLEY Antrumkürette, Satz à 6 Stück, Fig. 1-6, 18cm <i>COAKLEY antrum curette, set of 6, fig. 1-6, 18cm</i>
<b>LD-001-021</b>	COAKLEY Antrumkürette, Fig. 1, 18cm <i>COAKLEY antrum curette, fig. 1, 18cm</i>
<b>LD-001-022</b>	COAKLEY Antrumkürette, Fig. 2, 18cm <i>COAKLEY antrum curette, fig. 2, 18cm</i>
<b>LD-001-023</b>	COAKLEY Antrumkürette, Fig. 3, 18cm <i>COAKLEY antrum curette, fig. 3, 18cm</i>
<b>LD-001-024</b>	COAKLEY Antrumkürette, Fig. 4, 18cm <i>COAKLEY antrum curette, fig. 4, 18cm</i>
<b>LD-001-025</b>	COAKLEY Antrumkürette, Fig. 5, 18cm <i>COAKLEY antrum curette, fig. 5, 18cm</i>
<b>LD-001-026</b>	COAKLEY Antrumkürette, Fig. 6, 18cm <i>COAKLEY antrum curette, fig. 6, 18cm</i>
<b>LD-001-027</b>	COAKLEY Antrumkürette, vorwärts schneidend, 20cm <i>COAKLEY antrum curette, forward cutting, 20cm</i>
<b>LD-001-028</b>	COAKLEY Antrumkürette, rückwärts schneidend, 20cm <i>COAKLEY antrum curette, backward cutting, 20cm</i>
<b>LD-001-038</b>	FAULKNER Kieferhöhlenkürette, 19cm <i>FAULKNER antrum curette, 19cm</i>
<b>LD-001-191</b>	Antrum Kürette, längsoval 2mm, 20cm <i>Antrum curette, oval 2mm, 20cm</i>



**LD-001-039**  
bis / to  
**LD-001-039-2**



**LD-001-045**



**LD-001-101 /  
LD-001-102**



**LD-001-047**



**LD-001-046**

<b>Bestell-Nr. Ordering no.</b>	<b>Bezeichnung Description</b>
<b>LD-001-039</b>	HALLE Kieferhöhlenlöffel, biegsam, Größe 1, 21cm <i>HALLE antrum spoon, malleable, size 1, 21cm</i>
<b>LD-001-039-1</b>	HALLE Kieferhöhlenlöffel, biegsam, Größe 2, 21cm <i>HALLE antrum spoon, malleable, size 2, 21cm</i>
<b>LD-001-039-2</b>	HALLE Kieferhöhlenlöffel, biegsam, Größe 3, 21cm <i>HALLE antrum spoon, malleable, size 3, 21cm</i>
<b>LD-001-045</b>	Antrum-Löffel, rund, 19cm <i>Antrum spoon, round, 19cm</i>
<b>LD-001-046</b>	JANSEN Doppellöffel, 16cm <i>JANSEN spoon, double ended, 16cm</i>
<b>LD-001-047</b>	BARTH Doppellöffel, 18cm <i>BARTH spoon, double ended, 18cm</i>
<b>LD-001-101</b>	Antrumlöffel (KUHNBÖGLER), 55° abgewinkelt, längsoval, 19cm <i>Antrum spoon (KUHNBÖGLER), 55° angled, small oval, 19cm</i>
<b>LD-001-102</b>	Antrumlöffel, sehr stark abgewinkelt, längsoval <i>Antrum spoon, very strong angled, small oval</i>



**LD-001-012 /  
LD-001-013**



**LD-003-005**



**LD-001-030**  
bis / to  
**LD-001-032**



**LB-005-030**  
bis / to  
**LB-005-034**

Bestell-Nr. Ordering no.	Bezeichnung Description
<b>LB-005-030</b>	RITTER-HALLE Sinus Dilator, Ø 2.0mm, 14.5cm <i>RITTER-HALLE frontal sinus bougie, Ø 2.0mm, 14.5cm</i>
<b>LB-005-031</b>	RITTER-HALLE Sinus Dilator, Ø 2.5mm, 14.5cm <i>RITTER-HALLE frontal sinus bougie, Ø 2.5mm, 14.5cm</i>
<b>LB-005-032</b>	RITTER-HALLE Sinus Dilator, Ø 3.0mm, 14.5cm <i>RITTER-HALLE frontal sinus bougie, Ø 3.0mm, 14.5cm</i>
<b>LB-005-033</b>	RITTER-HALLE Sinus Dilator, Ø 4.0mm, 14.5cm <i>RITTER-HALLE frontal sinus bougie, Ø 4.0mm, 14.5cm</i>
<b>LB-005-034</b>	RITTER-HALLE Sinus Dilator, Ø 5.0mm, 14.5cm <i>RITTER-HALLE frontal sinus bougie, Ø 5.0mm, 14.5cm</i>
<b>LD-001-012</b>	Sichelmesser, spitz, 20cm <i>Sickle knife, pointed, 20cm</i>
<b>LD-001-013</b>	Sichelmesser, stumpf, 20cm <i>Sickle knife, blunt, 20cm</i>
<b>LD-003-005</b>	PLESTER Sichelmesser, zweischneidig, mittlere Biegung, 16cm <i>PLESTER sickle knife, double cutting, middle curved, 16cm</i>
<b>LD-001-030</b>	Stirnhöhlen-Dilatator, Ø 2.5mm, 16cm <i>Frontal sinus bougie, Ø 2.5mm, 16cm</i>
<b>LD-001-031</b>	Stirnhöhlen-Dilatator, Ø 2.5mm, 16cm <i>Frontal sinus bougie, Ø 2.5mm, 16cm</i>
<b>LD-001-032</b>	Stirnhöhlen-Dilatator, Ø 2.5mm, 16cm <i>Frontal sinus bougie, Ø 2.5mm, 16cm</i>





**LD-001-167**



**LD-001-165**



**LD-001-169**



**LD-001-093**  
bis / to  
**LD-001-095**



**LD-001-166**



**LD-001-168**

<b>Bestell-Nr.</b> <b>Ordering no.</b>	<b>Bezeichnung</b> <b>Description</b>
<b>LD-001-093</b>	LEMPERT Elevator, gerade, 2mm breit, 19cm <i>LEMPERT elevator, straight, 2mm wide, 19cm</i>
<b>LD-001-094</b>	LEMPERT Elevator, gebogen, 2mm breit, 19cm <i>LEMPERT elevator, curved, 2mm wide, 19cm</i>
<b>LD-001-095</b>	LEMPERT Elevator, gebogen, 3mm breit, 19cm <i>LEMPERT elevator, curved, 3mm wide, 19cm</i>
<b>LD-001-165</b>	FREER Elevator, 6.5mm, 20cm <i>FREER elevator, 6.5mm, 20cm</i>
<b>LD-001-166</b>	ROGER D. Elevator, gebogen, 18cm <i>ROGER D. elevator, curved, 18cm</i>
<b>LD-001-167</b>	JOSEPH-MASING Elevator, 21cm <i>JOSEPH-MASING elevator, 21cm</i>
<b>LD-001-168</b>	Elevator mit Kugelenden, 18cm <i>Ostium seeker, 18cm</i>
<b>LD-001-169</b>	SEWALL Elevator, 6mm, stumpf, 20cm <i>SEWALL elevator, 6mm, blunt, 20cm</i>



LD-001-037



LD-002-219



LD-001-035 /  
LD-001-036



LD-001-163



LD-002-365 /  
LD-002-366



LD-002-367 /  
LD-002-368

Bestell-Nr. Ordering no.	Bezeichnung Description
LD-001-035	WIENER Antrum Raspel, spitz gross, 18cm <i>WIENER antrum rasp, pointed big, 18cm</i>
LD-001-036	WIENER Antrum Raspel, stumpf gross, 18cm <i>WIENER antrum rasp, blunt big, 18cm</i>
LD-001-037	WATSON-WILLIAMS Stirnhöhlenraspel, stumpf, 23cm <i>WATSON-WILLIAMS antrum, blunt, 23cm</i>
LD-001-163	FREER Raspatorium, scharf, 18cm <i>FREER raspatory, sharp, 18cm</i>
LD-002-219	BRAWLEY Kieferhöhlenraspel, stumpf, 20cm <i>BRAWLEY antrum rasp, blunt, 20cm</i>
LD-002-365	WEST Flachmeißel, 4mm breit, 18cm <i>WEST chisel, 4mm wide, 18cm</i>
LD-002-366	WEST Flachmeißel, 6mm breit, 18cm <i>WEST chisel, 6mm wide, 18cm</i>
LD-002-367	WEST Hohlmeißel, 4mm breit, 18cm <i>WEST gouge, 4mm wide, 18cm</i>
LD-002-368	WEST Hohlmeißel, 6mm breit, 18cm <i>WEST gouge, 6mm wide, 18cm</i>



**LH-001-000**  
bis / to  
**LH-001-007**



**LH-001-011**  
bis / to  
**LH-001-019**

<b>Bestell-Nr.</b> <b>Ordering no.</b>	<b>Bezeichnung</b> <b>Description</b>
<b>LH-001-000</b>	VON EICKEN Kieferhöhlen-Spülkanüle, Ø 2.5mm, kurz gebogen <i>VON EICKEN antrum cannula, Ø 2.5mm, short curved</i>
<b>LH-001-001</b>	VON EICKEN Kieferhöhlen-Spülkanüle, Ø 3mm, kurz gebogen <i>VON EICKEN antrum cannula, Ø 3mm, short curved</i>
<b>LH-001-002</b>	VON EICKEN Kieferhöhlen-Spülkanüle, Ø 4mm, kurz gebogen <i>VON EICKEN antrum cannula, Ø 4mm, short curved</i>
<b>LH-001-003</b>	VON EICKEN Kieferhöhlen-Spülkanüle, Ø 3mm, lang gebogen <i>VON EICKEN antrum cannula, Ø 3mm, long curved</i>
<b>LH-001-004</b>	VON EICKEN Kieferhöhlen-Spülkanüle, Ø 4mm, lang gebogen <i>VON EICKEN antrum cannula, Ø 4mm, long curved</i>
<b>LH-001-005</b>	VON EICKEN Kieferhöhlen-Spülkanüle, Ø 3.5mm, kurz gebogen <i>VON EICKEN antrum cannula, Ø 3.5mm, short curved</i>
<b>LH-001-006</b>	VON EICKEN Kieferhöhlen-Spülkanüle, Ø 2.5mm, lang gebogen <i>VON EICKEN antrum cannula, Ø 2.5mm, long curved</i>
<b>LH-001-007</b>	VON EICKEN Kieferhöhlen-Spülkanüle, Ø 3.5mm, lang gebogen <i>VON EICKEN antrum cannula, Ø 3.5mm, long curved</i>
<b>LH-001-011</b>	FRAZIER Spülkanüle, gerade, Ø 5 Ch., NL 130mm <i>FRAZIER suction cannula, straight, Ø 5 Fr., WL 130mm</i>
<b>LH-001-012</b>	FRAZIER Spülkanüle, gerade, Ø 6 Ch., NL 130mm <i>FRAZIER suction cannula, straight, Ø 6 Fr., WL 130mm</i>
<b>LH-001-013</b>	FRAZIER Spülkanüle, gerade, Ø 7 Ch., NL 130mm <i>FRAZIER suction cannula, straight, Ø 7 Fr., WL 130mm</i>
<b>LH-001-014</b>	FRAZIER Spülkanüle, gerade, Ø 8 Ch., NL 130mm <i>FRAZIER suction cannula, straight, Ø 8 Fr., WL 130mm</i>
<b>LH-001-015</b>	FRAZIER Spülkanüle, gerade, Ø 9 Ch., NL 130mm <i>FRAZIER suction cannula, straight, Ø 9 Fr., WL 130mm</i>
<b>LH-001-016</b>	FRAZIER Spülkanüle, gerade, Ø 10 Ch., NL 130mm <i>FRAZIER suction cannula, straight, Ø 10 Fr., WL 130mm</i>
<b>LH-001-017</b>	FRAZIER Spülkanüle, gerade, Ø 11 Ch., NL 130mm <i>FRAZIER suction cannula, straight, Ø 11 Fr., WL 130mm</i>
<b>LH-001-018</b>	FRAZIER Spülkanüle, gerade, Ø 12 Ch., NL 130mm <i>FRAZIER suction cannula, straight, Ø 12 Fr., WL 130mm</i>
<b>LH-001-019</b>	FRAZIER Spülkanüle, gerade, Ø 14 Ch., NL 130mm <i>FRAZIER suction cannula, straight, Ø 14 Fr., WL 130mm</i>



**LH-001-041**  
bis / to  
**LH-001-050**



**LH-001-021**  
bis / to  
**LH-001-029**

Bestell-Nr. Ordering no.	Bezeichnung Description
<b>LH-001-021</b>	FRAZIER Spülkanüle, gerade, Ø 5 Ch., NL 170mm FRAZIER suction cannula, straight, Ø 5 Fr., WL 170mm
<b>LH-001-022</b>	FRAZIER Spülkanüle, gerade, Ø 6 Ch., NL 170mm FRAZIER suction cannula, straight, Ø 6 Fr., WL 170mm
<b>LH-001-023</b>	FRAZIER Spülkanüle, gerade, Ø 7 Ch., NL 170mm FRAZIER suction cannula, straight, Ø 7 Fr., WL 170mm
<b>LH-001-024</b>	FRAZIER Spülkanüle, gerade, Ø 8 Ch., NL 170mm FRAZIER suction cannula, straight, Ø 8 Fr., WL 170mm
<b>LH-001-025</b>	FRAZIER Spülkanüle, gerade, Ø 9 Ch., NL 170mm FRAZIER suction cannula, straight, Ø 9 Fr., WL 170mm
<b>LH-001-026</b>	FRAZIER Spülkanüle, gerade, Ø 10 Ch., NL 170mm FRAZIER suction cannula, straight, Ø 10 Fr., WL 170mm
<b>LH-001-027</b>	FRAZIER Spülkanüle, gerade, Ø 11 Ch., NL 170mm FRAZIER suction cannula, straight, Ø 11 Fr., WL 170mm
<b>LH-001-028</b>	FRAZIER Spülkanüle, gerade, Ø 12 Ch., NL 170mm FRAZIER suction cannula, straight, Ø 12 Fr., WL 170mm
<b>LH-001-029</b>	FRAZIER Spülkanüle, gerade, Ø 14 Ch., NL 170mm FRAZIER suction cannula, straight, Ø 14 Fr., WL 170mm
<b>LH-001-041</b>	FRAZIER Spülkanüle, gebogen, Ø 5 Ch., NL 100mm FRAZIER suction cannula, curved, Ø 5 Fr., WL 100mm
<b>LH-001-042</b>	FRAZIER Spülkanüle, gebogen, Ø 6 Ch., NL 100mm FRAZIER suction cannula, curved, Ø 6 Fr., WL 100mm
<b>LH-001-043</b>	FRAZIER Spülkanüle, gebogen, Ø 7 Ch., NL 100mm FRAZIER suction cannula, curved, Ø 7 Fr., WL 100mm
<b>LH-001-044</b>	FRAZIER Spülkanüle, gebogen, Ø 8 Ch., NL 100mm FRAZIER suction cannula, curved, Ø 8 Fr., WL 100mm
<b>LH-001-045</b>	FRAZIER Spülkanüle, gebogen, Ø 9 Ch., NL 100mm FRAZIER suction cannula, curved, Ø 9 Fr., WL 100mm
<b>LH-001-046</b>	FRAZIER Spülkanüle, gebogen, Ø 10 Ch., NL 100mm FRAZIER suction cannula, curved, Ø 10 Fr., WL 100mm
<b>LH-001-047</b>	FRAZIER Spülkanüle, gebogen, Ø 11 Ch., NL 100mm FRAZIER suction cannula, curved, Ø 11 Fr., WL 100mm
<b>LH-001-048</b>	FRAZIER Spülkanüle, gebogen, Ø 12 Ch., NL 100mm FRAZIER suction cannula, curved, Ø 12 Fr., WL 100mm
<b>LH-001-049</b>	FRAZIER Spülkanüle, gebogen, Ø 14 Ch., NL 100mm FRAZIER suction cannula, curved, Ø 14 Fr., WL 100mm
<b>LH-001-050</b>	FRAZIER Spülkanüle, gebogen, Ø 15 Ch., NL 100mm FRAZIER suction cannula, curved, Ø 15 Fr., WL 100mm



**LH-001-071 /  
LH-001-073**



**LH-001-072 /  
LH-001-075 /  
LH-001-076**



**LH-001-074**



**LH-001-060  
bis / to  
LH-001-062**



**LH-001-065  
bis / to  
LH-001-067**



**LH-001-058 /  
LH-001-059**

<b>Bestell-Nr. Ordering no.</b>	<b>Bezeichnung Description</b>
<b>LH-001-058</b>	VANALEYA Stirnhöhlenkanüle, kurze Biegung, Ø 1.8mm, 11.5cm <i>VANALEYA antrum cannula, short curve, Ø1.8mm, 11.5cm</i>
<b>LH-001-059</b>	VANALEYA Stirnhöhlenkanüle, lange Biegung, Ø 1.8mm, 11.5cm <i>VANALEYA antrum cannula, long curve, Ø1.8mm, 11.5cm</i>
<b>LH-001-060</b>	ADSON Spülkanüle, gebogen, Ø 11 Ch., NL 100mm <i>ADSON suction cannula, curved, Ø 11 Fr., WL 100mm</i>
<b>LH-001-061</b>	ADSON Spülkanüle, gebogen, Ø 12 Ch., NL 150mm <i>ADSON suction cannula, curved, Ø 12 Fr., WL 150mm</i>
<b>LH-001-062</b>	ADSON Spülkanüle, gebogen, Ø 15 Ch., NL 150mm <i>ADSON suction cannula, curved, Ø 15 Fr., WL 150mm</i>
<b>LH-001-065</b>	PLESTER Spülkanüle, gebogen, Ø 2.0mm, NL 135mm <i>PLESTER suction cannula, curved, Ø 2.0mm, WL 135mm</i>
<b>LH-001-066</b>	PLESTER Spülkanüle, gebogen, Ø 2.5mm, NL 135mm <i>PLESTER suction cannula, curved, Ø 2.5mm, WL 135mm</i>
<b>LH-001-067</b>	PLESTER Spülkanüle, gebogen, Ø 3.0mm, NL 135mm <i>PLESTER suction cannula, curved, Ø 3.0mm, WL 135mm</i>
<b>LH-001-071</b>	YANKAUER Spülkanüle, gebogen, Ø 18 Ch., NL 300mm <i>YANKAUER suction cannula, curved, Ø 18 Fr., WL 300mm</i>
<b>LH-001-072</b>	ANDREW-PYNCHON Spülkanüle, gebogen, Ø 2.7mm, NL 240mm <i>ANDREW-PYNCHON suction cannula, curved, Ø 2.7mm, WL 240mm</i>
<b>LH-001-075</b>	ANDREW-PYNCHON Spülkanüle, gebogen, Ø 3.0mm, NL 240mm <i>ANDREW-PYNCHON suction cannula, curved, Ø 3.0mm, WL 240mm</i>
<b>LH-001-076</b>	ANDREW-PYNCHON Spülkanüle, gebogen, Ø 3.4mm, NL 240mm <i>ANDREW-PYNCHON suction cannula, curved, Ø 3.4mm, WL 240mm</i>
<b>LH-001-073</b>	YANKAUER-BABY Spülkanüle, gebogen, Ø 18 Ch., NL 220mm <i>YANKAUER-BABY suction cannula, curved, Ø 18 Fr., WL 220mm</i>
<b>LH-001-074</b>	COUPLAND Spülkanüle, gebogen, 2 Ansätze, Ø 1.5mm und 2.0mm, NL 260mm <i>COUPLAND suction cannula, curved, 2 tips, Ø 1.5mm and 2.0mm, WL 260mm</i>



**LH-001-081**  
bis / to  
**LH-001-099**

Bestell-Nr. Ordering no.	Bezeichnung Description
LH-001-081	FRAZIER Spülkanüle, 45° gebogen, Ø 5 Ch., NL 90mm FRAZIER suction cannula, 45° curved, Ø 5 Fr., WL 90mm
LH-001-082	FRAZIER Spülkanüle, 45° gebogen, Ø 6 Ch., NL 90mm FRAZIER suction cannula, 45° curved, Ø 6 Fr., WL 90mm
LH-001-083	FRAZIER Spülkanüle, 45° gebogen, Ø 7 Ch., NL 90mm FRAZIER suction cannula, 45° curved, Ø 7 Fr., WL 90mm
LH-001-084	FRAZIER Spülkanüle, 45° gebogen, Ø 8 Ch., NL 90mm FRAZIER suction cannula, 45° curved, Ø 8 Fr., WL 90mm
LH-001-085	FRAZIER Spülkanüle, 45° gebogen, Ø 9 Ch., NL 90mm FRAZIER suction cannula, 45° curved, Ø 9 Fr., WL 90mm
LH-001-086	FRAZIER Spülkanüle, 45° gebogen, Ø 10 Ch., NL 90mm FRAZIER suction cannula, 45° curved, Ø 10 Fr., WL 90mm
LH-001-087	FRAZIER Spülkanüle, 45° gebogen, Ø 11 Ch., NL 90mm FRAZIER suction cannula, 45° curved, Ø 11 Fr., WL 90mm
LH-001-088	FRAZIER Spülkanüle, 45° gebogen, Ø 12 Ch., NL 90mm FRAZIER suction cannula, 45° curved, Ø 12 Fr., WL 90mm
LH-001-089	FRAZIER Spülkanüle, 45° gebogen, Ø 15 Ch., NL 90mm FRAZIER suction cannula, 45° curved, Ø 15 Fr., WL 90mm
LH-001-092	FRAZIER Spülkanüle, 45° gebogen, Ø 6 Ch., NL 110mm FRAZIER suction cannula, 45° curved, Ø 6 Fr., WL 110mm
LH-001-093	FRAZIER Spülkanüle, 45° gebogen, Ø 7 Ch., NL 110mm FRAZIER suction cannula, 45° curved, Ø 7 Fr., WL 110mm
LH-001-094	FRAZIER Spülkanüle, 45° gebogen, Ø 8 Ch., NL 110mm FRAZIER suction cannula, 45° curved, Ø 8 Fr., WL 110mm
LH-001-095	FRAZIER Spülkanüle, 45° gebogen, Ø 9 Ch., NL 110mm FRAZIER suction cannula, 45° curved, Ø 9 Fr., WL 110mm
LH-001-096	FRAZIER Spülkanüle, 45° gebogen, Ø 10 Ch., NL 110mm FRAZIER suction cannula, 45° curved, Ø 10 Fr., WL 110mm
LH-001-097	FRAZIER Spülkanüle, 45° gebogen, Ø 11 Ch., NL 110mm FRAZIER suction cannula, 45° curved, Ø 11 Fr., WL 110mm
LH-001-098	FRAZIER Spülkanüle, 45° gebogen, Ø 12 Ch., NL 110mm FRAZIER suction cannula, 45° curved, Ø 12 Fr., WL 110mm
LH-001-099	FRAZIER Spülkanüle, 45° gebogen, Ø 15 Ch., NL 110mm FRAZIER suction cannula, 45° curved, Ø 15 Fr., WL 110mm



**LH-001-102**  
bis / to  
**LH-001-119**

<b>Bestell-Nr.</b> <b>Ordering no.</b>	<b>Bezeichnung</b> <b>Description</b>
<b>LH-001-102</b>	FRAZIER Spülkanüle, 45° gebogen, Ø 6 Ch., NL 130mm FRAZIER suction cannula, 45° curved, Ø 6 Fr., WL 130mm
<b>LH-001-103</b>	FRAZIER Spülkanüle, 45° gebogen, Ø 7 Ch., NL 130mm FRAZIER suction cannula, 45° curved, Ø 7 Fr., WL 130mm
<b>LH-001-104</b>	FRAZIER Spülkanüle, 45° gebogen, Ø 8 Ch., NL 130mm FRAZIER suction cannula, 45° curved, Ø 8 Fr., WL 130mm
<b>LH-001-105</b>	FRAZIER Spülkanüle, 45° gebogen, Ø 9 Ch., NL 130mm FRAZIER suction cannula, 45° curved, Ø 9 Fr., WL 130mm
<b>LH-001-106</b>	FRAZIER Spülkanüle, 45° gebogen, Ø 10 Ch., NL 130mm FRAZIER suction cannula, 45° curved, Ø 10 Fr., WL 130mm
<b>LH-001-107</b>	FRAZIER Spülkanüle, 45° gebogen, Ø 11 Ch., NL 130mm FRAZIER suction cannula, 45° curved, Ø 11 Fr., WL 130mm
<b>LH-001-108</b>	FRAZIER Spülkanüle, 45° gebogen, Ø 12 Ch., NL 130mm FRAZIER suction cannula, 45° curved, Ø 12 Fr., WL 130mm
<b>LH-001-109</b>	FRAZIER Spülkanüle, 45° gebogen, Ø 15 Ch., NL 130mm FRAZIER suction cannula, 45° curved, Ø 15 Fr., WL 130mm
<b>LH-001-112</b>	FRAZIER Spülkanüle, 45° gebogen, Ø 6 Ch., NL 150mm FRAZIER suction cannula, 45° curved, Ø 6 Fr., WL 150mm
<b>LH-001-113</b>	FRAZIER Spülkanüle, 45° gebogen, Ø 7 Ch., NL 150mm FRAZIER suction cannula, 45° curved, Ø 7 Fr., WL 150mm
<b>LH-001-114</b>	FRAZIER Spülkanüle, 45° gebogen, Ø 8 Ch., NL 150mm FRAZIER suction cannula, 45° curved, Ø 8 Fr., WL 150mm
<b>LH-001-115</b>	FRAZIER Spülkanüle, 45° gebogen, Ø 9 Ch., NL 150mm FRAZIER suction cannula, 45° curved, Ø 9 Fr., WL 150mm
<b>LH-001-116</b>	FRAZIER Spülkanüle, 45° gebogen, Ø 10 Ch., NL 150mm FRAZIER suction cannula, 45° curved, Ø 10 Fr., WL 150mm
<b>LH-001-117</b>	FRAZIER Spülkanüle, 45° gebogen, Ø 11 Ch., NL 150mm FRAZIER suction cannula, 45° curved, Ø 11 Fr., WL 150mm
<b>LH-001-118</b>	FRAZIER Spülkanüle, 45° gebogen, Ø 12 Ch., NL 150mm FRAZIER suction cannula, 45° curved, Ø 12 Fr., WL 150mm
<b>LH-001-119</b>	FRAZIER Spülkanüle, 45° gebogen, Ø 15 Ch., NL 150mm FRAZIER suction cannula, 45° curved, Ø 15 Fr., WL 150mm





**LH-001-122**  
bis / to  
**LH-001-139**

Bestell-Nr. Ordering no.	Bezeichnung Description
<b>LH-001-122</b>	FRAZIER Spülkanüle, 45° gebogen, Ø 6 Ch., NL 190mm FRAZIER suction cannula, 45° curved, Ø 6 Fr., WL 190mm
<b>LH-001-123</b>	FRAZIER Spülkanüle, 45° gebogen, Ø 7 Ch., NL 190mm FRAZIER suction cannula, 45° curved, Ø 7 Fr., WL 190mm
<b>LH-001-124</b>	FRAZIER Spülkanüle, 45° gebogen, Ø 8 Ch., NL 190mm FRAZIER suction cannula, 45° curved, Ø 8 Fr., WL 190mm
<b>LH-001-125</b>	FRAZIER Spülkanüle, 45° gebogen, Ø 9 Ch., NL 190mm FRAZIER suction cannula, 45° curved, Ø 9 Fr., WL 190mm
<b>LH-001-126</b>	FRAZIER Spülkanüle, 45° gebogen, Ø 10 Ch., NL 190mm FRAZIER suction cannula, 45° curved, Ø 10 Fr., WL 190mm
<b>LH-001-127</b>	FRAZIER Spülkanüle, 45° gebogen, Ø 11 Ch., NL 190mm FRAZIER suction cannula, 45° curved, Ø 11 Fr., WL 190mm
<b>LH-001-128</b>	FRAZIER Spülkanüle, 45° gebogen, Ø 12 Ch., NL 190mm FRAZIER suction cannula, 45° curved, Ø 12 Fr., WL 190mm
<b>LH-001-129</b>	FRAZIER Spülkanüle, 45° gebogen, Ø 15 Ch., NL 190mm FRAZIER suction cannula, 45° curved, Ø 15 Fr., WL 190mm
<b>LH-001-132</b>	FRAZIER Spülkanüle, 45° gebogen, Ø 6 Fr., NL 250mm FRAZIER suction cannula, 45° curved, Ø 6 Ch., WL 250mm
<b>LH-001-133</b>	FRAZIER Spülkanüle, 45° gebogen, Ø 7 Fr., NL 250mm FRAZIER suction cannula, 45° curved, Ø 7 Ch., WL 250mm
<b>LH-001-134</b>	FRAZIER Spülkanüle, 45° gebogen, Ø 8 Fr., NL 250mm FRAZIER suction cannula, 45° curved, Ø 8 Ch., WL 250mm
<b>LH-001-135</b>	FRAZIER Spülkanüle, 45° gebogen, Ø 9 Fr., NL 250mm FRAZIER suction cannula, 45° curved, Ø 9 Ch., WL 250mm
<b>LH-001-136</b>	FRAZIER Spülkanüle, 45° gebogen, Ø 10 Fr., NL 250mm FRAZIER suction cannula, 45° curved, Ø 10 Ch., WL 250mm
<b>LH-001-137</b>	FRAZIER Spülkanüle, 45° gebogen, Ø 11 Fr., NL 250mm FRAZIER suction cannula, 45° curved, Ø 11 Ch., WL 250mm
<b>LH-001-138</b>	FRAZIER Spülkanüle, 45° gebogen, Ø 12 Fr., NL 250mm FRAZIER suction cannula, 45° curved, Ø 12 Ch., WL 250mm
<b>LH-001-139</b>	FRAZIER Spülkanüle, 45° gebogen, Ø 15 Fr., NL 250mm FRAZIER suction cannula, 45° curved, Ø 15 Ch., WL 250mm



**LH-001-141**  
bis / to  
**LH-001-149**

<b>Bestell-Nr.</b> <b>Ordering no.</b>	<b>Bezeichnung</b> <b>Description</b>
<b>LH-001-141</b>	FRAZIER Spülkanüle, 90° gebogen, Ø 5 Ch., NL 70mm FRAZIER suction cannula, 90° curved, Ø 5 Fr., WL 70mm
<b>LH-001-142</b>	FRAZIER Spülkanüle, 90° gebogen, Ø 6 Ch., NL 70mm FRAZIER suction cannula, 90° curved, Ø 6 Fr., WL 70mm
<b>LH-001-143</b>	FRAZIER Spülkanüle, 90° gebogen, Ø 7 Ch., NL 70mm FRAZIER suction cannula, 90° curved, Ø 7 Fr., WL 70mm
<b>LH-001-144</b>	FRAZIER Spülkanüle, 90° gebogen, Ø 8 Ch., NL 70mm FRAZIER suction cannula, 90° curved, Ø 8 Fr., WL 70mm
<b>LH-001-145</b>	FRAZIER Spülkanüle, 90° gebogen, Ø 9 Ch., NL 70mm FRAZIER suction cannula, 90° curved, Ø 9 Fr., WL 70mm
<b>LH-001-146</b>	FRAZIER Spülkanüle, 90° gebogen, Ø 10 Ch., NL 70mm FRAZIER suction cannula, 90° curved, Ø 10 Fr., WL 70mm
<b>LH-001-147</b>	FRAZIER Spülkanüle, 90° gebogen, Ø 11 Ch., NL 70mm FRAZIER suction cannula, 90° curved, Ø 11 Fr., WL 70mm
<b>LH-001-148</b>	FRAZIER Spülkanüle, 90° gebogen, Ø 12 Ch., NL 70mm FRAZIER suction cannula, 90° curved, Ø 12 Fr., WL 70mm
<b>LH-001-149</b>	FRAZIER Spülkanüle, 90° gebogen, Ø 13 Ch., NL 70mm FRAZIER suction cannula, 90° curved, Ø 13 Fr., WL 70mm



**LH-001-151**  
bis / to  
**LH-001-168**

Bestell-Nr. Ordering no.	Bezeichnung Description
<b>LH-001-151</b>	POPPEN Spülkanüle, gebogen, Ø 6 Ch., NL 90mm <i>POPPEN suction cannula, curved, Ø 6 Fr., WL 90mm</i>
<b>LH-001-152</b>	POPPEN Spülkanüle, gebogen, Ø 7 Ch., NL 90mm <i>POPPEN suction cannula, curved, Ø 7 Fr., WL 90mm</i>
<b>LH-001-153</b>	POPPEN Spülkanüle, gebogen, Ø 8 Ch., NL 90mm <i>POPPEN suction cannula, curved, Ø 8 Fr., WL 90mm</i>
<b>LH-001-154</b>	POPPEN Spülkanüle, gebogen, Ø 9 Ch., NL 90mm <i>POPPEN suction cannula, curved, Ø 9 Fr., WL 90mm</i>
<b>LH-001-155</b>	POPPEN Spülkanüle, gebogen, Ø 10 Ch., NL 90mm <i>POPPEN suction cannula, curved, Ø 10 Fr., WL 90mm</i>
<b>LH-001-156</b>	POPPEN Spülkanüle, gebogen, Ø 11 Ch., NL 90mm <i>POPPEN suction cannula, curved, Ø 11 Fr., WL 90mm</i>
<b>LH-001-157</b>	POPPEN Spülkanüle, gebogen, Ø 12 Ch., NL 90mm <i>POPPEN suction cannula, curved, Ø 12 Fr., WL 90mm</i>
<b>LH-001-158</b>	POPPEN Spülkanüle, gebogen, Ø 15 Ch., NL 90mm <i>POPPEN suction cannula, curved, Ø 15 Fr., WL 90mm</i>
<b>LH-001-161</b>	POPPEN Spülkanüle, gebogen, Ø 6 Ch., NL 145mm <i>POPPEN suction cannula, curved, Ø 6 Fr., WL 145mm</i>
<b>LH-001-162</b>	POPPEN Spülkanüle, gebogen, Ø 7 Ch., NL 145mm <i>POPPEN suction cannula, curved, Ø 7 Fr., WL 145mm</i>
<b>LH-001-163</b>	POPPEN Spülkanüle, gebogen, Ø 8 Ch., NL 145mm <i>POPPEN suction cannula, curved, Ø 8 Fr., WL 145mm</i>
<b>LH-001-164</b>	POPPEN Spülkanüle, gebogen, Ø 9 Ch., NL 145mm <i>POPPEN suction cannula, curved, Ø 9 Fr., WL 145mm</i>
<b>LH-001-165</b>	POPPEN Spülkanüle, gebogen, Ø 10 Ch., NL 145mm <i>POPPEN suction cannula, curved, Ø 10 Fr., WL 145mm</i>
<b>LH-001-166</b>	POPPEN Spülkanüle, gebogen, Ø 11 Ch., NL 145mm <i>POPPEN suction cannula, curved, Ø 11 Fr., WL 145mm</i>
<b>LH-001-167</b>	POPPEN Spülkanüle, gebogen, Ø 12 Ch., NL 145mm <i>POPPEN suction cannula, curved, Ø 12 Fr., WL 145mm</i>
<b>LH-001-168</b>	POPPEN Spülkanüle, gebogen, Ø 15 Ch., NL 145mm <i>POPPEN suction cannula, curved, Ø 15 Fr., WL 145mm</i>



**LH-001-300**  
bis / to  
**LH-001-309**



**LH-001-260**  
bis / to  
**LH-001-264**



**LJ-003-026**

<b>Bestell-Nr.</b> <b>Ordering no.</b>	<b>Bezeichnung</b> <b>Description</b>
<b>LH-001-260</b>	FERGUSON Saugrohr, mit Unterbrecherloch und Mandrin, LL, 6 Ch., NL 11 cm <i>FERGUSON suction cannula, with cut-off hole and mandrin, LL, 6 Fr., WL 11 cm</i>
<b>LH-001-261</b>	FERGUSON Saugrohr, mit Unterbrecherloch und Mandrin, LL, 8 Ch., NL 11 cm <i>FERGUSON suction cannula, with cut-off hole and mandrin, LL, 8 Fr., WL 11 cm</i>
<b>LH-001-262</b>	FERGUSON Saugrohr, mit Unterbrecherloch und Mandrin, LL, 10 Ch., NL 11 cm <i>FERGUSON suction cannula, with cut-off hole and mandrin, LL, 10 Fr., WL 11 cm</i>
<b>LH-001-263</b>	FERGUSON Saugrohr, mit Unterbrecherloch und Mandrin, LL, 12 Ch., NL 11 cm <i>FERGUSON suction cannula, with cut-off hole and mandrin, LL, 12 Fr., WL 11 cm</i>
<b>LH-001-264</b>	FERGUSON Saugrohr, mit Unterbrecherloch und Mandrin, LL, 15 Ch., NL 11 cm <i>FERGUSON suction cannula, with cut-off hole and mandrin, LL, 15 Fr., WL 11 cm</i>
<b>LH-001-300</b>	SIEBENMANN Kieferhöhlen-Spülrohr, Öffnung unten, Ø 1.5mm <i>SIEBENMANN antrum cannula, downward hole, Ø 1.5mm</i>
<b>LH-001-301</b>	SIEBENMANN Kieferhöhlen-Spülrohr, Öffnung unten, Ø 1.7mm <i>SIEBENMANN antrum cannula, downward hole, Ø 1.7mm</i>
<b>LH-001-302</b>	SIEBENMANN Kieferhöhlen-Spülrohr, Öffnung unten, Ø 2.0mm <i>SIEBENMANN antrum cannula, downward hole, Ø 2.0mm</i>
<b>LH-001-303</b>	SIEBENMANN Kieferhöhlen-Spülrohr, Öffnung unten, Ø 2.5mm <i>SIEBENMANN antrum cannula, downward hole, Ø 2.5mm</i>
<b>LH-001-304</b>	SIEBENMANN Kieferhöhlen-Spülrohr, Öffnung unten, Ø 3.0mm <i>SIEBENMANN antrum cannula, downward hole, Ø 3.0mm</i>
<b>LH-001-305</b>	SIEBENMANN Kieferhöhlen-Spülrohr, Öffnung oben, Ø 1.5mm <i>SIEBENMANN antrum cannula, upward hole, Ø 1.5mm</i>
<b>LH-001-306</b>	SIEBENMANN Kieferhöhlen-Spülrohr, Öffnung oben, Ø 1.7mm <i>SIEBENMANN antrum cannula, upward hole, Ø 1.7mm</i>
<b>LH-001-307</b>	SIEBENMANN Kieferhöhlen-Spülrohr, Öffnung oben, Ø 2.0mm <i>SIEBENMANN antrum cannula, upward hole, Ø 2.0mm</i>
<b>LH-001-308</b>	SIEBENMANN Kieferhöhlen-Spülrohr, Öffnung oben, Ø 2.5mm <i>SIEBENMANN antrum cannula, upward hole, Ø 2.5mm</i>
<b>LH-001-309</b>	SIEBENMANN Kieferhöhlen-Spülrohr, Öffnung oben, Ø 3.0mm <i>SIEBENMANN antrum cannula, upward hole, Ø 3.0mm</i>
<b>LJ-003-026</b>	MUCK Saugglas mit Gummistopfer <i>MUCK nasal suction cup, glass</i>

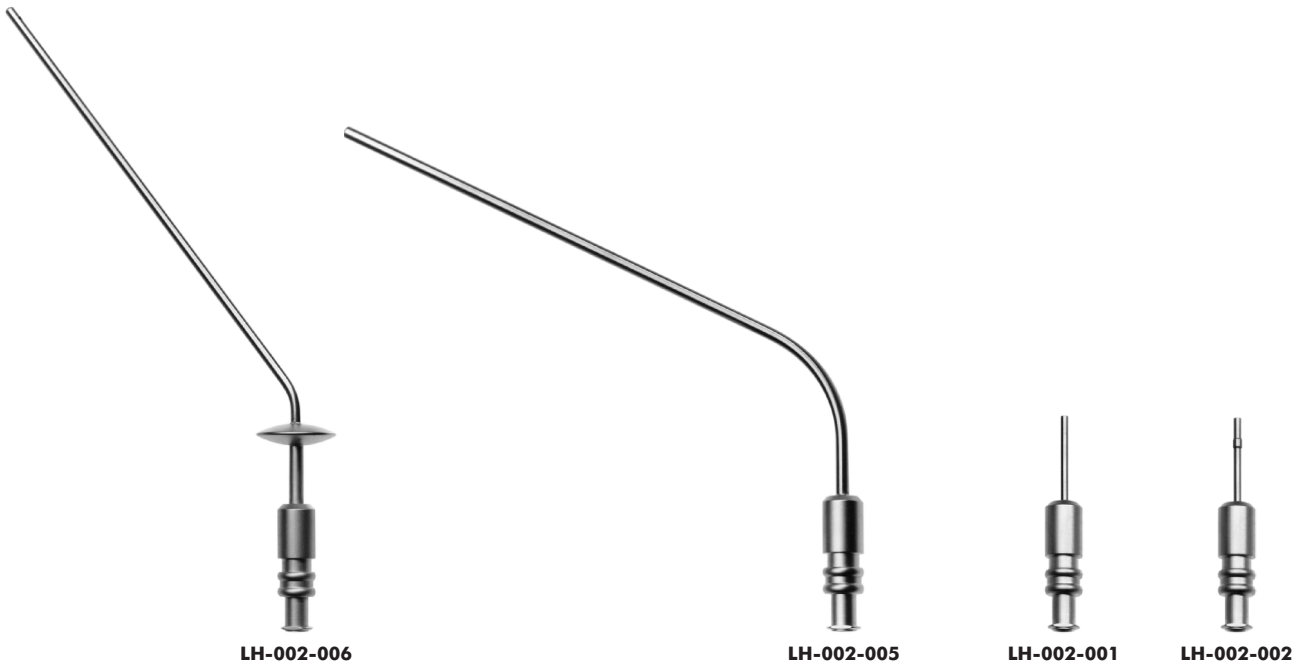

Bestell-Nr. Ordering no.	Bezeichnung Description
LH-002-001	Spülkanüle kurz <i>Antrum cannula short</i>
LH-002-002	Spülkanüle kurz mit Wulst <i>Antrum cannula short with stop ring</i>
LH-002-005	Spülrohr Ø 3mm <i>Irrigation tube Ø 3mm</i>
LH-002-006	Spülrohr Ø 2.5mm mit Teller <i>Irrigation tube Ø 2.5mm with plate</i>



**LH-003-001**  
bis / to  
**LH-003-012**



**LH-002-009**



**LH-004-001**  
bis / to  
**LH-004-005**



**LH-002-020**  
bis / to  
**LH-002-022**

<b>Bestell-Nr.</b> <b>Ordering no.</b>	<b>Bezeichnung</b> <b>Description</b>
<b>LH-002-009</b>	Saug-Spülrohr, Ø 4mm <i>Suction irrigation tube, Ø 4mm</i>
<b>LH-002-020</b>	LICHTWITZ Kieferhöhlenpunktionskanüle, Ø 1.5mm, NL 10cm <i>LICHTWITZ antrum cannula, Ø 1.5mm, WL 10cm</i>
<b>LH-002-021</b>	LICHTWITZ Kieferhöhlenpunktionskanüle, Ø 1.8mm, NL 10cm <i>LICHTWITZ antrum cannula, Ø 1.8mm, WL 10cm</i>
<b>LH-002-022</b>	LICHTWITZ Kieferhöhlenpunktionskanüle, Ø 2mm, NL 10cm <i>LICHTWITZ antrum cannula, Ø 2mm, WL 10cm</i>
<b>LH-003-001</b>	Koagulations-Saugrohr, gerade, Ø 3.5mm, 100mm <i>Coagulation suction tube, straight, Ø 3.5mm, 100mm</i>
<b>LH-003-002</b>	Koagulations-Saugrohr, gerade, Ø 3.5mm, 260mm <i>Coagulation suction tube, straight, Ø 3.5mm, 260mm</i>
<b>LH-003-011</b>	Koagulations-Saugrohr, gerade, Ø 5mm, 260mm <i>Coagulation suction tube, straight, Ø 5mm, 260mm</i>
<b>LH-003-012</b>	Koagulations-Saugrohr, gerade, Ø 5mm, 300mm <i>Coagulation suction tube, straight, Ø 5mm, 300mm</i>
<b>LH-004-001</b>	Septum-Kanüle, gerade, LL-Anschluss <i>Septum needle, straight, LL connection</i>
<b>LH-004-002</b>	Septum-Kanüle, kniegebogen, LL-Anschluss <i>Septum needle, angular, LL connection</i>
<b>LH-004-003</b>	Septum-Kanüle, 90° gebogen, LL-Anschluss <i>Septum needle, 90° curved, LL connection</i>
<b>LH-004-004</b>	Septum-Kanüle, 45° gebogen, LL-Anschluss <i>Septum needle, 45° curved, LL connection</i>
<b>LH-004-005</b>	Septum-Kanüle, bajonettförmig, LL-Anschluss <i>Septum needle, bayonet shaped, LL connection</i>

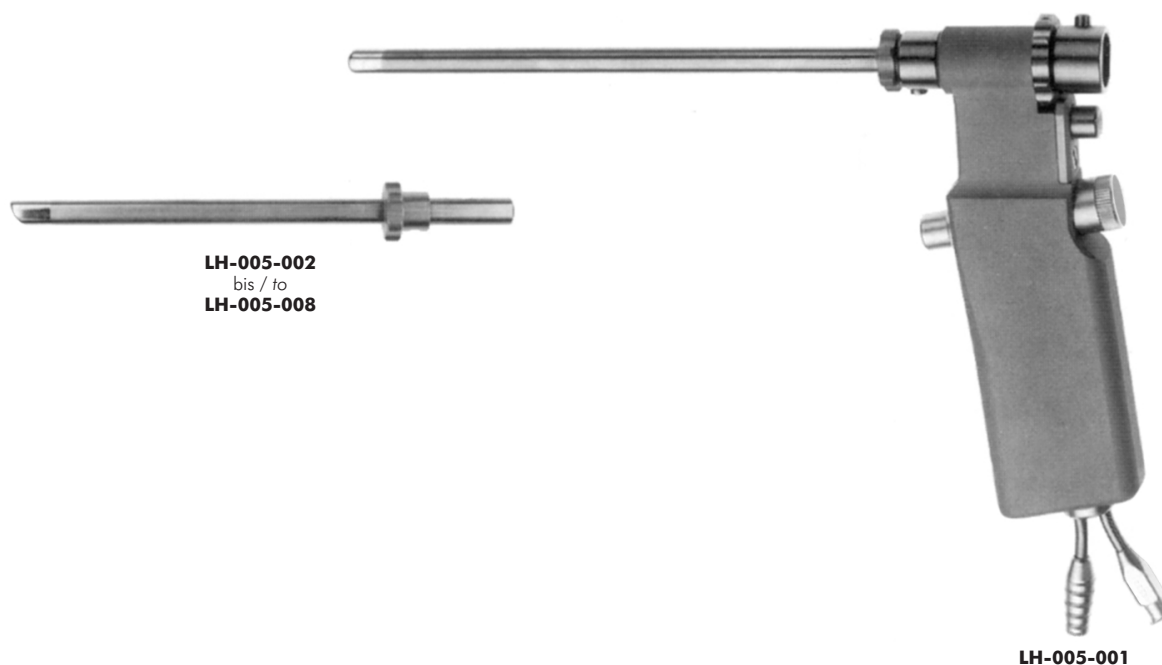

Bestell-Nr. Ordering no.	Bezeichnung Description
LH-005-001	Saug-Spülhandgriff zur Verwendung mit austauschbaren Schäften <i>Suction-irrigation handle for use with exchangeable sheaths</i>
LH-005-002	Austauschbarer Saug-Spülschaft zur Verwendung mit LH-005-001, für Optiken 2.7mm/0°/187.5mm <i>Exchangeable suction-irrigation sheath for use with LH-005-001, for scopes 2.7mm/0°/187.5mm</i>
LH-005-003	Austauschbarer Saug-Spülschaft zur Verwendung mit LH-005-001, für Optiken 2.7mm/30°/187.5mm <i>Exchangeable suction-irrigation sheath for use with LH-005-001, for scopes 2.7mm/30°/187.5mm</i>
LH-005-004	Austauschbarer Saug-Spülschaft zur Verwendung mit LH-005-001, für Optiken 2.7mm/70°/187.5mm <i>Exchangeable suction-irrigation sheath for use with LH-005-001, for scopes 2.7mm/70°/187.5mm</i>
LH-005-005	Austauschbarer Saug-Spülschaft zur Verwendung mit LH-005-001, für Optiken 4.0mm/0°/187.5mm <i>Exchangeable suction-irrigation sheath for use with LH-005-001, for scopes 4.0mm/0°/187.5mm</i>
LH-005-006	Austauschbarer Saug-Spülschaft zur Verwendung mit LH-005-001, für Optiken 4.0mm/30°/187.5mm <i>Exchangeable suction-irrigation sheath for use with LH-005-001, for scopes 4.0mm/30°/187.5mm</i>
LH-005-007	Austauschbarer Saug-Spülschaft zur Verwendung mit LH-005-001, für Optiken 4.0mm/45°/187.5mm <i>Exchangeable suction-irrigation sheath for use with LH-005-001, for scopes 4.0mm/45°/187.5mm</i>
LH-005-008	Austauschbarer Saug-Spülschaft zur Verwendung mit LH-005-001, für Optiken 4.0mm/70°/187.5mm <i>Exchangeable suction-irrigation sheath for use with LH-005-001, for scopes 4.0mm/70°/187.5mm</i>





**LC-003-001-SS**  
bis / to  
**LC-003-011-SS**



**LC-004-003-SS**  
bis / to  
**LC-004-005-SS**



**LC-003-021-SS**  
bis / to  
**LC-003-023-SS**



**LC-005-001**  
bis / to  
**LC-005-003 /**  
**LC-005-001-SS**  
bis / to  
**LC-005-004-SS**



**LC-004-001 /**  
**LC-004-001-SS /**  
**LC-004-002-SS**



**LC-003-001-SS**  
bis / to  
**LC-005-004-SS**

<b>Bestell-Nr.</b> <b>Ordering no.</b>	<b>Bezeichnung</b> <b>Description</b>
<b>LC-003-001-SS</b>	GRÜNWALD Conchotom, durchschneidend, Fig. 1 <i>GRÜNWALD nasal forceps, cutting through, fig. 1</i>
<b>LC-003-002-SS</b>	GRÜNWALD Conchotom, durchschneidend, Fig. 2 <i>GRÜNWALD nasal forceps, cutting through, fig. 2</i>
<b>LC-003-003-SS</b>	GRÜNWALD Conchotom, durchschneidend, Fig. 3 <i>GRÜNWALD nasal forceps, cutting through, fig. 3</i>
<b>LC-003-011-SS</b>	GRÜNWALD Conchotom, durchscheidend, 30°aufgebogen <i>GRÜNWALD nasal forceps, cutting through, 30° upward</i>
<b>LC-003-021-SS</b>	SCHMEDEN Conchotom, durchschneidend, Fig. 1 <i>SCHMEDEN nasal forceps, cutting through, fig. 1</i>
<b>LC-003-022-SS</b>	SCHMEDEN Conchotom, durchschneidend, Fig. 2 <i>SCHMEDEN nasal forceps, cutting through, fig. 2</i>
<b>LC-003-023-SS</b>	SCHMEDEN Conchotom, durchschneidend, Fig. 3 <i>SCHMEDEN nasal forceps, cutting through, fig. 3</i>
<b>LC-004-001</b>	STRUYCKEN Conchotom, 11cm <i>STRUYCKEN nasal cutting forceps, 11cm</i>
<b>LC-004-001-SS</b>	STRUYCKEN Conchotom, Fig. 1, 1.0 x 15mm <i>STRUYCKEN nasal cutting forceps, fig. 1, 1.0 x 15mm</i>
<b>LC-004-002-SS</b>	STRUYCKEN Conchotom, Fig. 2, 1.5 x 15mm <i>STRUYCKEN nasal cutting forceps, fig. 2, 1.5 x 15mm</i>
<b>LC-004-003-SS</b>	MORIYAMA Conchotom, durchschneidend, aufgebogen <i>MORIYAMA nasal cutting forceps, cutting through, upward curved</i>
<b>LC-004-004-SS</b>	MORIYAMA Conchotom, durchschneidend, Schaft aufgebogen <i>MORIYAMA nasal cutting forceps, cutting through, sheath upward curved</i>
<b>LC-004-005-SS</b>	MORIYAMA Conchotom, durchschneidend, besonders zart, gerade <i>MORIYAMA nasal cutting forceps, cutting through, delicate, straight</i>
<b>LC-005-001</b>	HARTMANN Conchotom, 1cm <i>HARTMANN nasal cutting forceps, 1cm</i>
<b>LC-005-002</b>	HARTMANN Conchotom, 2cm <i>HARTMANN nasal cutting forceps, 2cm</i>
<b>LC-005-003</b>	HARTMANN Conchotom, 3cm <i>HARTMANN nasal cutting forceps, 3cm</i>
<b>LC-005-001-SS</b>	HARTMANN Conchotom, Ø 5mm <i>HARTMANN nasal cutting forceps, Ø 5mm</i>
<b>LC-005-002-SS</b>	HARTMANN Conchotom, Ø 7mm <i>HARTMANN nasal cutting forceps, Ø 7mm</i>
<b>LC-005-003-SS</b>	HARTMANN Conchotom, Ø 9mm <i>HARTMANN nasal cutting forceps, Ø 9mm</i>
<b>LC-005-004-SS</b>	HARTMANN Conchotom, Ø 11mm <i>HARTMANN nasal cutting forceps, Ø 11mm</i>



**LC-001-001**  
bis / to  
**LC-001-005**  
**LC-001-102 /**  
**LC-001-103**



**LC-001-011**  
bis / to  
**LC-001-015**



**LC-001-021**  
bis / to  
**LC-001-025**

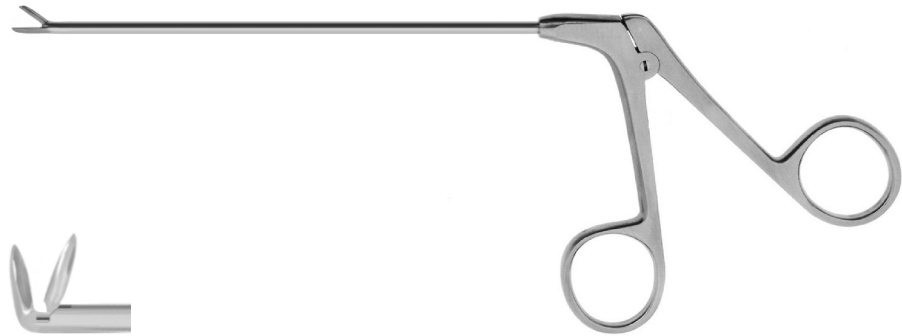

**LC-001-001**  
bis / to  
**LC-001-025**  
**LC-001-102 /**  
**LC-001-103**

Bestell-Nr. Ordering no.	Bezeichnung Description
<b>LC-001-001</b>	WEIL-BLAKESLEY Nasenzange, gerade, 2.5mm WEIL-BLAKESLEY nasal forceps, straight, 2.5mm
<b>LC-001-002</b>	WEIL-BLAKESLEY Nasenzange, gerade, 3.0mm WEIL-BLAKESLEY nasal forceps, straight, 3.0mm
<b>LC-001-003</b>	WEIL-BLAKESLEY Nasenzange, gerade, 3.6mm WEIL-BLAKESLEY nasal forceps, straight, 3.6mm
<b>LC-001-004</b>	WEIL-BLAKESLEY Nasenzange, gerade, 4.0mm WEIL-BLAKESLEY nasal forceps, straight, 4.0mm
<b>LC-001-005</b>	WEIL-BLAKESLEY Nasenzange, gerade, 5.0mm WEIL-BLAKESLEY nasal forceps, straight, 5.0mm
<b>LC-001-102</b>	WEIL-BLAKESLEY Nasenzange für Kinder, gerade, 3.0mm, NL 12cm WEIL-BLAKESLEY nasal forceps for children, straight, 3.0mm, WL 12cm
<b>LC-001-103</b>	WEIL-BLAKESLEY Nasenzange für Kinder, gerade, 3.6mm, NL 12cm WEIL-BLAKESLEY nasal forceps for children, straight, 3.6mm, WL 12cm
<b>LC-001-011</b>	WEIL-BLAKESLEY Nasenzange, 45° aufgebogen, 2.5mm WEIL-BLAKESLEY nasal forceps, 45° upward, 2.5mm
<b>LC-001-012</b>	WEIL-BLAKESLEY Nasenzange, 45° aufgebogen, 3.0mm WEIL-BLAKESLEY nasal forceps, 45° upward, 3.0mm
<b>LC-001-013</b>	WEIL-BLAKESLEY Nasenzange, 45° aufgebogen, 3.6mm WEIL-BLAKESLEY nasal forceps, 45° upward, 3.6mm
<b>LC-001-014</b>	WEIL-BLAKESLEY Nasenzange, 45° aufgebogen, 4.0mm WEIL-BLAKESLEY nasal forceps, 45° upward, 4.0mm
<b>LC-001-015</b>	WEIL-BLAKESLEY Nasenzange, 45° aufgebogen, 5.0mm WEIL-BLAKESLEY nasal forceps, 45° upward, 5.0mm
<b>LC-001-021</b>	WEIL-BLAKESLEY Nasenzange, 90° aufgebogen, 2.5mm WEIL-BLAKESLEY nasal forceps, 90° upward, 2.5mm
<b>LC-001-022</b>	WEIL-BLAKESLEY Nasenzange, 90° aufgebogen, 3.0mm WEIL-BLAKESLEY nasal forceps, 90° upward, 3.0mm
<b>LC-001-023</b>	WEIL-BLAKESLEY Nasenzange, 90° aufgebogen, 3.6mm WEIL-BLAKESLEY nasal forceps, 90° upward, 3.6mm
<b>LC-001-024</b>	WEIL-BLAKESLEY Nasenzange, 90° aufgebogen, 4.0mm WEIL-BLAKESLEY nasal forceps, 90° upward, 4.0mm
<b>LC-001-025</b>	WEIL-BLAKESLEY Nasenzange, 90° aufgebogen, 5.0mm WEIL-BLAKESLEY nasal forceps, 90° upward, 5.0mm

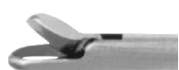
**LC-001-031**  
 bis / to  
**LC-001-035**

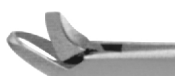
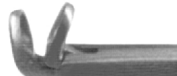
**LC-001-112**  
 bis / to  
**LC-001-114**

**LC-001-041**  
 bis / to  
**LC-001-045**

**LC-001-122**  
 bis / to  
**LC-001-124**

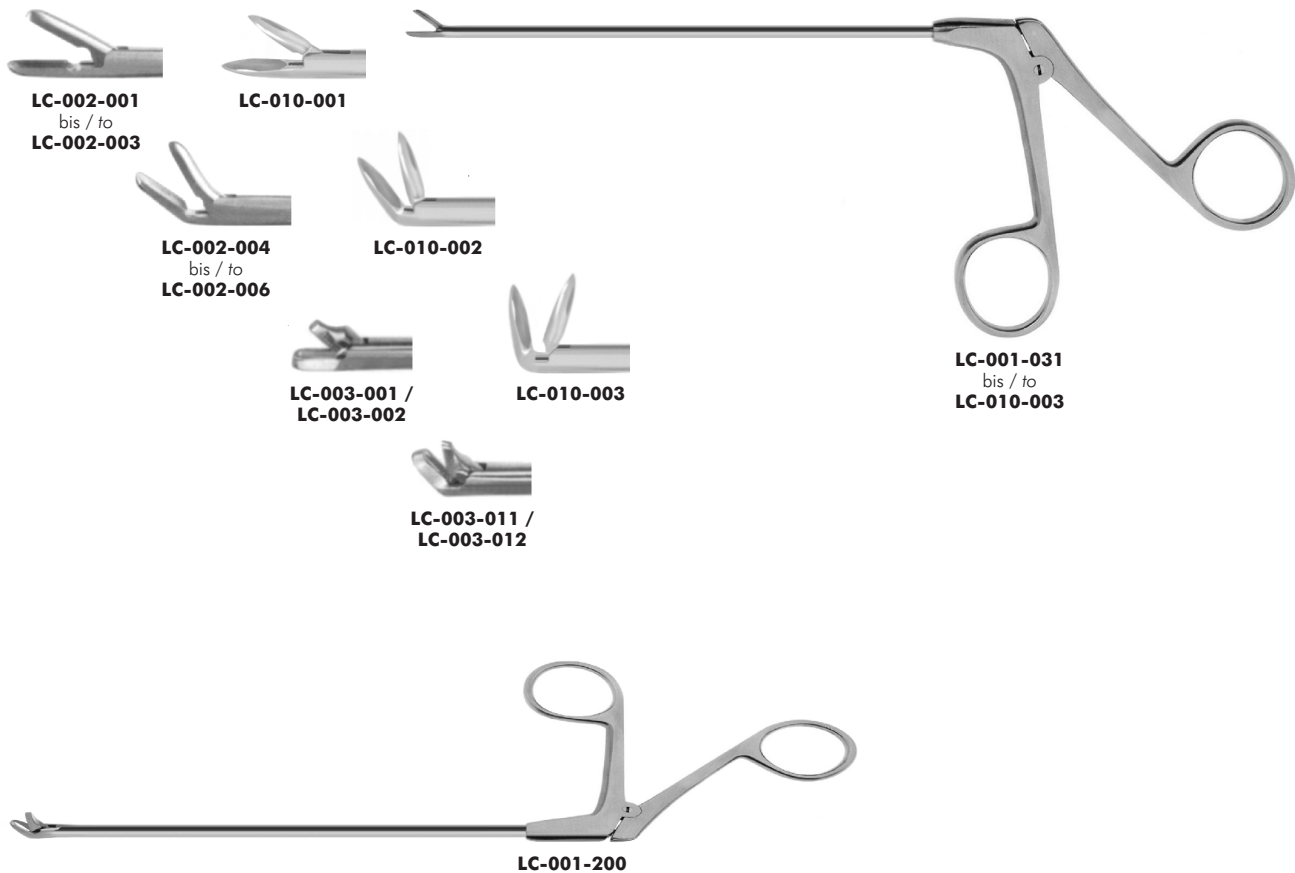
**LC-001-031**  
 bis / to  
**LC-001-124**

Bestell-Nr. Ordering no.	Bezeichnung Description
<b>LC-001-031</b>	WEIL-BLAKESLEY Nasenzange, gerade, durchschneidend, 2.5mm <i>WEIL-BLAKESLEY nasal forceps, straight, cutting through, 2.5mm</i>
<b>LC-001-032</b>	WEIL-BLAKESLEY Nasenzange, gerade, durchschneidend, 3.0mm <i>WEIL-BLAKESLEY nasal forceps, straight, cutting through, 3.0mm</i>
<b>LC-001-033</b>	WEIL-BLAKESLEY Nasenzange, gerade, durchschneidend, 3.6mm <i>WEIL-BLAKESLEY nasal forceps, straight, cutting through, 3.6mm</i>
<b>LC-001-034</b>	WEIL-BLAKESLEY Nasenzange, gerade, durchschneidend, 4.0mm <i>WEIL-BLAKESLEY nasal forceps, straight, cutting through, 4.0mm</i>
<b>LC-001-035</b>	WEIL-BLAKESLEY Nasenzange, gerade, durchschneidend, 5.0mm <i>WEIL-BLAKESLEY nasal forceps, straight, cutting through, 5.0mm</i>
<b>LC-001-041</b>	WEIL-BLAKESLEY Nasenzange, 45° aufgebogen, 2.5mm <i>WEIL-BLAKESLEY nasal forceps, 45° upward, 2.5mm</i>
<b>LC-001-042</b>	WEIL-BLAKESLEY Nasenzange, 45° aufgebogen, 3.0mm <i>WEIL-BLAKESLEY nasal forceps, 45° upward, 3.0mm</i>
<b>LC-001-043</b>	WEIL-BLAKESLEY Nasenzange, 45° aufgebogen, 3.6mm <i>WEIL-BLAKESLEY nasal forceps, 45° upward, 3.6mm</i>
<b>LC-001-044</b>	WEIL-BLAKESLEY Nasenzange, 45° aufgebogen, 4.0mm <i>WEIL-BLAKESLEY nasal forceps, 45° upward, 4.0mm</i>
<b>LC-001-045</b>	WEIL-BLAKESLEY Nasenzange, 45° aufgebogen, 5.0mm <i>WEIL-BLAKESLEY nasal forceps, 45° upward, 5.0mm</i>
<b>LC-001-112</b>	BLAKESLEY-WILDE Nasenzange, 45° aufgebogen, 3.0mm, Größe 1, AL 13cm <i>BLAKESLEY-WILDE nasal forceps, 45° upward, 3.0mm, size 1, WL 13cm</i>
<b>LC-001-113</b>	BLAKESLEY-WILDE Nasenzange, 45° aufgebogen, 3.6mm, Größe 2, AL 13cm <i>BLAKESLEY-WILDE nasal forceps, 45° upward, 3.6mm, size 2, WL 13cm</i>
<b>LC-001-114</b>	BLAKESLEY-WILDE Nasenzange, 45° aufgebogen, 4.0mm, Größe 3, AL 13cm <i>BLAKESLEY-WILDE nasal forceps, 45° upward, 4.0mm, size 3, WL 13cm</i>
<b>LC-001-122</b>	BLAKESLEY-WILDE Nasenzange, 90° aufgebogen, 3.0mm, Größe 1, AL 13cm <i>BLAKESLEY-WILDE nasal forceps, 90° upward, 3.0mm, size 1, WL 13cm</i>
<b>LC-001-123</b>	BLAKESLEY-WILDE Nasenzange, 90° aufgebogen, 3.6mm, Größe 2, AL 13cm <i>BLAKESLEY-WILDE nasal forceps, 90° upward, 3.6mm, size 2, WL 13cm</i>
<b>LC-001-124</b>	BLAKESLEY-WILDE Nasenzange, 90° aufgebogen, 4.0mm, Größe 3, AL 13cm <i>BLAKESLEY-WILDE nasal forceps, 90° upward, 4.0mm, size 3, WL 13cm</i>

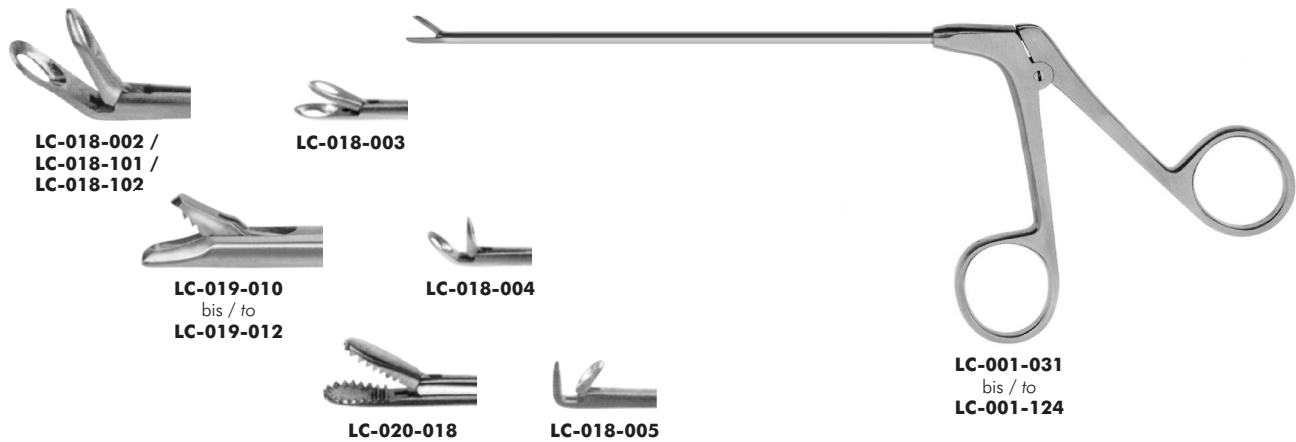

Bestell-Nr. Ordering no.	Bezeichnung Description
<b>LC-001-200</b>	BLAKESLEY-STAMMBERGER Nasenzange, 45° aufgebogen, 3.0mm, Größe 1, Griffposition rechts, AL 13cm <i>BLAKESLEY-STAMMBERGER nasal forceps, 45° upward, 3.0mm, size 1, position of the handle, WL 13cm</i>
<b>LC-002-001</b>	TAKAHASHI Nasenzange, gerade, Löffel 2x10mm, AL 12cm <i>TAKAHASHI nasal forceps, straight, spoon 2x10mm, WL 12cm</i>
<b>LC-002-002</b>	TAKAHASHI Nasenzange, gerade, Löffel 3x10mm, AL 12cm <i>TAKAHASHI nasal forceps, straight, spoon 3x10mm, WL 12cm</i>
<b>LC-002-003</b>	TAKAHASHI Nasenzange, gerade, Löffel 4x10mm, AL 12cm <i>TAKAHASHI nasal forceps, straight, spoon 4x10mm, WL 12cm</i>
<b>LC-002-004</b>	TAKAHASHI Nasenzange, 45° aufgebogen, Löffel 2x10mm, AL 12cm <i>TAKAHASHI nasal forceps, 45° upward, spoon 2x10mm, WL 12cm</i>
<b>LC-002-005</b>	TAKAHASHI Nasenzange, 45° aufgebogen, Löffel 3x10mm, AL 12cm <i>TAKAHASHI nasal forceps, 45° upward, spoon 3x10mm, WL 12cm</i>
<b>LC-002-006</b>	TAKAHASHI Nasenzange, 45° aufgebogen, Löffel 4x10mm, AL 12cm <i>TAKAHASHI nasal forceps, 45° upward, spoon 4x10mm, WL 12cm</i>
<b>LC-003-001</b>	GRÜNWALD Nasenzange, durchschneidend, 8x3mm <i>GRÜNWALD nasal forceps, cutting through, 8x3mm</i>
<b>LC-003-002</b>	GRÜNWALD Nasenzange, durchschneidend, 11.5x3.5mm <i>GRÜNWALD nasal forceps, cutting through, 11.5x3.5mm</i>
<b>LC-003-011</b>	GRÜNWALD Nasenzange, durchschneidend, 8x3mm, 45° aufgebogen <i>GRÜNWALD nasal forceps, cutting through, 8x3mm, 45° upward</i>
<b>LC-003-012</b>	GRÜNWALD Nasenzange, durchschneidend, 11.5x3.5mm, 45° aufgebogen <i>GRÜNWALD nasal forceps, cutting through, 11.5x3.5mm, 45° upward</i>
<b>LC-010-001</b>	Nebenhöhlenzange, gerade, NL 19cm <i>Sinus forceps, straight, WL 19cm</i>
<b>LC-010-002</b>	Nebenhöhlenzange, 60° aufgebogen, NL 19cm <i>Sinus forceps, 60° upward, WL 19cm</i>
<b>LC-010-003</b>	Nebenhöhlenzange, 90° aufgebogen, NL 19cm <i>Sinus forceps, 90° upward, WL 19cm</i>



Bestell-Nr. Ordering no.	Bezeichnung Description
LC-018-002	STRÜMPEL-VOSS Nasenzange, 45° aufgebogen, 3.0mm STRÜMPEL-VOSS nasal cutting forceps, 45° upward, 3.0mm
LC-018-003	STRÜMPEL Nasenzange, gerade, oval gefenstert, schlankes Modell, NL 10cm STRÜMPEL nasal cutting forceps, straight, oval cup shaped, slim modell, WL 10cm
LC-018-004	STRÜMPEL Nasenzange, 45° aufgebogen, schlankes Modell, NL 10cm STRÜMPEL nasal cutting forceps, 45° up curved, slim modell, WL 10cm
LC-018-005	STRÜMPEL Nasenzange, 90° aufgebogen, schlankes Modell, NL 10cm STRÜMPEL nasal cutting forceps, 90° up curved, slim modell, WL 10cm
LC-018-101	STRÜMPEL-VOSS Nasenzange, 45° aufgebogen, 2.5mm, NL 12cm STRÜMPEL-VOSS nasal cutting forceps, 45° upward, 2.5mm, WL 12cm
LC-018-102	STRÜMPEL-VOSS Nasenzange, 45° aufgebogen, 3.0mm, NL 12cm STRÜMPEL-VOSS nasal cutting forceps, 45° upward, 3.0mm, WL 12cm
LC-019-010	CASTELNUOVO miniatur Nasenzange, durchschneidend, 65° n. oben gebogen, Schnittbreite 1.5mm, NL 13cm CASTELNUOVO miniature nasal forceps, cutting through, 65° upturned, width of cut 1.5mm, WL 13cm
LC-019-011	CASTELNUOVO miniatur Nasenzange, links öffnend, durchschneidend, 65° n. oben gebogen, Schnittbr. 1.5mm, NL 13cm CASTELNUOVO miniature nasal forceps, left side open, cutting through, 65° upturned, width of cut 1.5mm, WL 13cm
LC-019-012	CASTELNUOVO miniatur Nasenzange, rechts öffnend, durchschn., 65° n. oben gebogen, Schnittbr. 1.5mm, NL 13cm CASTELNUOVO miniature nasal forceps, right side open, cutting through, 65° upturned, width of cut 1.5mm, WL 13cm
LC-020-018	RUDERT Nasenzange, gezahnt, 45° aufgebogen, NL 11cm RUDERT nasal cutting forceps, 45° upcurved, WL 11cm



**LC-001-001-S**  
bis / to  
**LC-001-005-S**



**LC-001-011-S**  
bis / to  
**LC-001-015-S**



**LC-001-021-S**  
bis / to  
**LC-001-025-S**



**LC-001-001-S**  
bis / to  
**LC-001-025-S**

Bestell-Nr. Ordering no.	Bezeichnung Description
<b>LC-001-001-S</b>	WEIL-BLAKESLEY Nasenzange, gerade, 2.5mm, mit Absaugung <i>WEIL-BLAKESLEY nasal forceps, straight, 2.5mm, with suction channel</i>
<b>LC-001-002-S</b>	WEIL-BLAKESLEY Nasenzange, gerade, 3.0mm, mit Absaugung <i>WEIL-BLAKESLEY nasal forceps, straight, 3.0mm, with suction channel</i>
<b>LC-001-003-S</b>	WEIL-BLAKESLEY Nasenzange, gerade, 3.6mm, mit Absaugung <i>WEIL-BLAKESLEY nasal forceps, straight, 3.6mm, with suction channel</i>
<b>LC-001-004-S</b>	WEIL-BLAKESLEY Nasenzange, gerade, 4.0mm, mit Absaugung <i>WEIL-BLAKESLEY nasal forceps, straight, 4.0mm, with suction channel</i>
<b>LC-001-005-S</b>	WEIL-BLAKESLEY Nasenzange, gerade, 5.0mm, mit Absaugung <i>WEIL-BLAKESLEY nasal forceps, straight, 5.0mm, with suction channel</i>
<b>LC-001-011-S</b>	WEIL-BLAKESLEY Nasenzange, 45° aufgebogen, 2.5mm, mit Absaugung <i>WEIL-BLAKESLEY nasal forceps, 45° upward, 2.5mm, with suction channel</i>
<b>LC-001-012-S</b>	WEIL-BLAKESLEY Nasenzange, 45° aufgebogen, 3.0mm, mit Absaugung <i>WEIL-BLAKESLEY nasal forceps, 45° upward, 3.0mm, with suction channel</i>
<b>LC-001-013-S</b>	WEIL-BLAKESLEY Nasenzange, 45° aufgebogen, 3.6mm, mit Absaugung <i>WEIL-BLAKESLEY nasal forceps, 45° upward, 3.6mm, with suction channel</i>
<b>LC-001-014-S</b>	WEIL-BLAKESLEY Nasenzange, 45° aufgebogen, 4.0mm, mit Absaugung <i>WEIL-BLAKESLEY nasal forceps, 45° upward, 4.0mm, with suction channel</i>
<b>LC-001-015-S</b>	WEIL-BLAKESLEY Nasenzange, 45° aufgebogen, 5.0mm, mit Absaugung <i>WEIL-BLAKESLEY nasal forceps, 45° upward, 5.0mm, with suction channel</i>
<b>LC-001-021-S</b>	WEIL-BLAKESLEY Nasenzange, 90° aufgebogen, 2.5mm, mit Absaugung <i>WEIL-BLAKESLEY nasal forceps, 90° upward, 2.5mm, with suction channel</i>
<b>LC-001-022-S</b>	WEIL-BLAKESLEY Nasenzange, 90° aufgebogen, 3.0mm, mit Absaugung <i>WEIL-BLAKESLEY nasal forceps, 90° upward, 3.0mm, with suction channel</i>
<b>LC-001-023-S</b>	WEIL-BLAKESLEY Nasenzange, 90° aufgebogen, 3.6mm, mit Absaugung <i>WEIL-BLAKESLEY nasal forceps, 90° upward, 3.6mm, with suction channel</i>
<b>LC-001-024-S</b>	WEIL-BLAKESLEY Nasenzange, 90° aufgebogen, 4.0mm, mit Absaugung <i>WEIL-BLAKESLEY nasal forceps, 90° upward, 4.0mm, with suction channel</i>
<b>LC-001-025-S</b>	WEIL-BLAKESLEY Nasenzange, 90° aufgebogen, 5.0mm, mit Absaugung <i>WEIL-BLAKESLEY nasal forceps, 90° upward, 5.0mm, with suction channel</i>





**LC-001-031-S**  
bis / to  
**LC-001-035-S**



**LC-002-011-S**  
bis / to  
**LC-002-013-S**



**LC-001-041-S**  
bis / to  
**LC-001-045-S**



**LC-002-014-S**  
bis / to  
**LC-002-006-S**



**LC-001-031-S**  
bis / to  
**LC-002-006-S**

Bestell-Nr. Ordering no.	Bezeichnung Description
<b>LC-001-031-S</b>	WEIL-BLAKESLEY Nasenzange, gerade, 2.5mm, mit Absaugung <i>WEIL-BLAKESLEY nasal forceps, straight, 2.5mm, with suction channel</i>
<b>LC-001-032-S</b>	WEIL-BLAKESLEY Nasenzange, gerade, 3.0mm, mit Absaugung <i>WEIL-BLAKESLEY nasal forceps, straight, 3.0mm, with suction channel</i>
<b>LC-001-033-S</b>	WEIL-BLAKESLEY Nasenzange, gerade, 3.6mm, mit Absaugung <i>WEIL-BLAKESLEY nasal forceps, straight, 3.6mm, with suction channel</i>
<b>LC-001-034-S</b>	WEIL-BLAKESLEY Nasenzange, gerade, 4.0mm, mit Absaugung <i>WEIL-BLAKESLEY nasal forceps, straight, 4.0mm, with suction channel</i>
<b>LC-001-035-S</b>	WEIL-BLAKESLEY Nasenzange, gerade, 5.0mm, mit Absaugung <i>WEIL-BLAKESLEY nasal forceps, straight, 5.0mm, with suction channel</i>
<b>LC-001-041-S</b>	WEIL-BLAKESLEY Nasenzange, 45° aufgebogen, 2.5mm, mit Absaugung <i>WEIL-BLAKESLEY nasal forceps, 45° upward, 2.5mm, with suction channel</i>
<b>LC-001-042-S</b>	WEIL-BLAKESLEY Nasenzange, 45° aufgebogen, 3.0mm, mit Absaugung <i>WEIL-BLAKESLEY nasal forceps, 45° upward, 3.0mm, with suction channel</i>
<b>LC-001-043-S</b>	WEIL-BLAKESLEY Nasenzange, 45° aufgebogen, 3.6mm, mit Absaugung <i>WEIL-BLAKESLEY nasal forceps, 45° upward, 3.6mm, with suction channel</i>
<b>LC-001-044-S</b>	WEIL-BLAKESLEY Nasenzange, 45° aufgebogen, 4.0mm, mit Absaugung <i>WEIL-BLAKESLEY nasal forceps, 45° upward, 4.0mm, with suction channel</i>
<b>LC-001-045-S</b>	WEIL-BLAKESLEY Nasenzange, 45° aufgebogen, 5.0mm, mit Absaugung <i>WEIL-BLAKESLEY nasal forceps, 45° upward, 5.0mm, with suction channel</i>
<b>LC-002-011-S</b>	TAKAHASHI Nasenzange, gerade, Löffel 2x10mm, AL 12cm, mit Absaugung <i>TAKAHASHI nasal forceps, straight, spoon 2x10mm, WL 12cm, with suction channel</i>
<b>LC-002-012-S</b>	TAKAHASHI Nasenzange, gerade, Löffel 3x10mm, AL 12cm, mit Absaugung <i>TAKAHASHI nasal forceps, straight, spoon 3x10mm, WL 12cm, with suction channel</i>
<b>LC-002-013-S</b>	TAKAHASHI Nasenzange, gerade, Löffel 4x10mm, AL 12cm, mit Absaugung <i>TAKAHASHI nasal forceps, straight, spoon 4x10mm, WL 12cm, with suction channel</i>
<b>LC-002-014-S</b>	TAKAHASHI Nasenzange, 45° aufgebogen, Löffel 2x10mm, AL 12cm, mit Absaugung <i>TAKAHASHI nasal forceps, 45° upward, spoon 2x10mm, WL 12cm, with suction channel</i>
<b>LC-002-015-S</b>	TAKAHASHI Nasenzange, 45° aufgebogen, Löffel 3x10mm, AL 12cm, mit Absaugung <i>TAKAHASHI nasal forceps, 45° upward, spoon 3x10mm, WL 12cm, with suction channel</i>
<b>LC-002-016-S</b>	TAKAHASHI Nasenzange, 45° aufgebogen, Löffel 4x10mm, AL 12cm, mit Absaugung <i>TAKAHASHI nasal forceps, 45° upward, spoon 4x10mm, WL 12cm, with suction channel</i>





**LC-001-001-SS**  
bis / to  
**LC-001-007-SS**



**LC-001-011-SS**  
bis / to  
**LC-001-017-SS**



**LC-001-022-SS**  
bis / to  
**LC-001-026-SS**



**LC-001-001-SS**  
bis / to  
**LC-001-026-SS**

Bestell-Nr. Ordering no.	Bezeichnung Description
<b>LC-001-001-SS</b>	WEIL-BLAKESLEY Nasenzange, gerade, 2.5mm WEIL-BLAKESLEY nasal forceps, straight, 2.5mm
<b>LC-001-002-SS</b>	WEIL-BLAKESLEY Nasenzange, gerade, 3.0mm WEIL-BLAKESLEY nasal forceps, straight, 3.0mm
<b>LC-001-003-SS</b>	WEIL-BLAKESLEY Nasenzange, gerade, 3.6mm WEIL-BLAKESLEY nasal forceps, straight, 3.6mm
<b>LC-001-004-SS</b>	WEIL-BLAKESLEY Nasenzange, gerade, 4.2mm WEIL-BLAKESLEY nasal forceps, straight, 4.2mm
<b>LC-001-005-SS</b>	WEIL-BLAKESLEY Nasenzange, gerade, 4.8mm WEIL-BLAKESLEY nasal forceps, straight, 4.8mm
<b>LC-001-006-SS</b>	WEIL-BLAKESLEY Nasenzange, gerade, 5.3mm WEIL-BLAKESLEY nasal forceps, straight, 5.3mm
<b>LC-001-007-SS</b>	WEIL-BLAKESLEY Nasenzange, gerade, 6.3mm WEIL-BLAKESLEY nasal forceps, straight, 6.3mm
<b>LC-001-011-SS</b>	WEIL-BLAKESLEY Nasenzange, 45° aufgebogen, 2.5mm WEIL-BLAKESLEY nasal forceps, 45° upward, 2.5mm
<b>LC-001-012-SS</b>	WEIL-BLAKESLEY Nasenzange, 45° aufgebogen, 3.0mm WEIL-BLAKESLEY nasal forceps, 45° upward, 3.0mm
<b>LC-001-013-SS</b>	WEIL-BLAKESLEY Nasenzange, 45° aufgebogen, 3.6mm WEIL-BLAKESLEY nasal forceps, 45° upward, 3.6mm
<b>LC-001-014-SS</b>	WEIL-BLAKESLEY Nasenzange, 45° aufgebogen, 4.2mm WEIL-BLAKESLEY nasal forceps, 45° upward, 4.2mm
<b>LC-001-015-SS</b>	WEIL-BLAKESLEY Nasenzange, 45° aufgebogen, 4.8mm WEIL-BLAKESLEY nasal forceps, 45° upward, 4.8mm
<b>LC-001-016-SS</b>	WEIL-BLAKESLEY Nasenzange, 45° aufgebogen, 5.3mm WEIL-BLAKESLEY nasal forceps, 45° upward, 5.3mm
<b>LC-001-017-SS</b>	WEIL-BLAKESLEY Nasenzange, 45° aufgebogen, 6.3mm WEIL-BLAKESLEY nasal forceps, 45° upward, 6.3mm
<b>LC-001-022-SS</b>	WEIL-BLAKESLEY Nasenzange, 90° aufgebogen, 3.0mm WEIL-BLAKESLEY nasal forceps, 90° upward, 3.0mm
<b>LC-001-023-SS</b>	WEIL-BLAKESLEY Nasenzange, 90° aufgebogen, 3.6mm WEIL-BLAKESLEY nasal forceps, 90° upward, 3.6mm
<b>LC-001-024-SS</b>	WEIL-BLAKESLEY Nasenzange, 90° aufgebogen, 4.2mm WEIL-BLAKESLEY nasal forceps, 90° upward, 4.2mm
<b>LC-001-025-SS</b>	WEIL-BLAKESLEY Nasenzange, 90° aufgebogen, 5.0mm WEIL-BLAKESLEY nasal forceps, 90° upward, 5.0mm
<b>LC-001-026-SS</b>	WEIL-BLAKESLEY Nasenzange, langes Maul, 90° aufgebogen, 3.6mm WEIL-BLAKESLEY nasal forceps, long jaw, 90° upward, 3.6mm



**LC-001-031-SS**  
 bis / to  
**LC-001-053-SS**



**LC-001-061-SS**  
 bis / to  
**LC-001-065-SS**



**LC-001-031-SS**  
 bis / to  
**LC-001-065-SS**

<b>Bestell-Nr.</b> <b>Ordering no.</b>	<b>Bezeichnung</b> <b>Description</b>
<b>LC-001-031-SS</b>	WEIL-BLAKESLEY Nasenzange, gerade, 2.5mm, durchschneidend <i>WEIL-BLAKESLEY nasal forceps, straight, 2.5mm, cutting through</i>
<b>LC-001-033-SS</b>	WEIL-BLAKESLEY Nasenzange, gerade, 3.6mm, durchschneidend <i>WEIL-BLAKESLEY nasal forceps, straight, 3.6mm, cutting through</i>
<b>LC-001-034-SS</b>	WEIL-BLAKESLEY Nasenzange, gerade, 4.0mm, durchschneidend <i>WEIL-BLAKESLEY nasal forceps, straight, 4.0mm, cutting through</i>
<b>LC-001-035-SS</b>	WEIL-BLAKESLEY Nasenzange, gerade, 4.8mm, durchschneidend <i>WEIL-BLAKESLEY nasal forceps, straight, 4.8mm, cutting through</i>
<b>LC-001-041-SS</b>	WEIL-BLAKESLEY Nasenzange, links gebogen, 2.5mm <i>WEIL-BLAKESLEY nasal forceps, curved left, 2.5mm</i>
<b>LC-001-043-SS</b>	WEIL-BLAKESLEY Nasenzange, links gebogen, 3.6mm <i>WEIL-BLAKESLEY nasal forceps, curved left, 3.6mm</i>
<b>LC-001-051-SS</b>	WEIL-BLAKESLEY Nasenzange, rechts gebogen, 2.5mm <i>WEIL-BLAKESLEY nasal forceps, curved right, 2.5mm</i>
<b>LC-001-053-SS</b>	WEIL-BLAKESLEY Nasenzange, rechts gebogen, 3.6mm <i>WEIL-BLAKESLEY nasal forceps, curved right, 3.6mm</i>
<b>LC-001-061-SS</b>	WEIL-BLAKESLEY Nasenzange, 45° aufgebogen, 2.5mm, durchschneidend <i>WEIL-BLAKESLEY nasal forceps, 45° upward, 2.5mm, cutting through</i>
<b>LC-001-063-SS</b>	WEIL-BLAKESLEY Nasenzange, 45° aufgebogen, 3.6mm, durchschneidend <i>WEIL-BLAKESLEY nasal forceps, 45° upward, 3.6mm, cutting through</i>
<b>LC-001-064-SS</b>	WEIL-BLAKESLEY Nasenzange, 45° aufgebogen, 4.0mm, durchschneidend <i>WEIL-BLAKESLEY nasal forceps, 45° upward, 4.0mm, cutting through</i>
<b>LC-001-065-SS</b>	WEIL-BLAKESLEY Nasenzange, 45° aufgebogen, 4.8mm, durchschneidend <i>WEIL-BLAKESLEY nasal forceps, 45° upward, 4.8mm, cutting through</i>



**LC-002-001-SS /  
LC-002-002-SS /  
LC-002-003-SS**



**LC-002-111-SS  
bis / to  
LC-002-115-SS**



**LC-018-001-SS**



**LC-002-004-SS /  
LC-002-005-SS /  
LC-002-006-SS**



**LC-002-122-SS  
bis / to  
LC-002-124-SS**



**LC-002-001-SS  
bis / to  
LC-018-001-SS**

Bestell-Nr. Ordering no.	Bezeichnung Description
<b>LC-002-001-SS</b>	TAKAHASHI Nasenzange 2 x 10mm, gerade <i>TAKAHASHI nasal forceps 2 x 10mm, straight</i>
<b>LC-002-002-SS</b>	TAKAHASHI Nasenzange 3 x 10mm, gerade <i>TAKAHASHI nasal forceps 3 x 10mm, straight</i>
<b>LC-002-003-SS</b>	TAKAHASHI Nasenzange 4 x 10mm, gerade <i>TAKAHASHI nasal forceps 4 x 10mm, straight</i>
<b>LC-002-004-SS</b>	TAKAHASHI Nasenzange 2 x 10mm, 45° aufgebogen <i>TAKAHASHI nasal forceps 2 x 10mm, 45° upward</i>
<b>LC-002-005-SS</b>	TAKAHASHI Nasenzange 3 x 10mm, 45° aufgebogen <i>TAKAHASHI nasal forceps 3 x 10mm, 45° upward</i>
<b>LC-002-006-SS</b>	TAKAHASHI Nasenzange 4 x 10mm, 45° aufgebogen <i>TAKAHASHI nasal forceps 4 x 10mm, 45° upward</i>
<b>LC-002-111-SS</b>	BLAKESLEY-WILDE Nasenzange, 45° aufgebogen, 2.5mm, Größe 0, AL 11cm <i>BLAKESLEY-WILDE nasal forceps, 45° upward, 2.5mm, size 0, WL 11cm</i>
<b>LC-002-112-SS</b>	BLAKESLEY-WILDE Nasenzange, 45° aufgebogen, 3.0mm, Größe 1, AL 11cm <i>BLAKESLEY-WILDE nasal forceps, 45° upward, 3.0mm, size 1, WL 11cm</i>
<b>LC-002-113-SS</b>	BLAKESLEY-WILDE Nasenzange, 45° aufgebogen, 3.6mm, Größe 2, AL 11cm <i>BLAKESLEY-WILDE nasal forceps, 45° upward, 3.6mm, size 2, WL 11cm</i>
<b>LC-002-114-SS</b>	BLAKESLEY-WILDE Nasenzange, 45° aufgebogen, 4.0mm, Größe 3, AL 11cm <i>BLAKESLEY-WILDE nasal forceps, 45° upward, 4.0mm, size 3, WL 11cm</i>
<b>LC-002-115-SS</b>	BLAKESLEY-WILDE Nasenzange, 45° aufgebogen, 5.0mm, Größe 4, AL 11cm <i>BLAKESLEY-WILDE nasal forceps, 45° upward, 5.0mm, size 4, WL 11cm</i>
<b>LC-002-122-SS</b>	BLAKESLEY-WILDE Nasenzange, 90° aufgebogen, 3.0mm, Größe 1, AL 11cm <i>BLAKESLEY-WILDE nasal forceps, 90° upward, 3.0mm, size 1, WL 11cm</i>
<b>LC-002-123-SS</b>	BLAKESLEY-WILDE Nasenzange, 90° aufgebogen, 3.6mm, Größe 2, AL 11cm <i>BLAKESLEY-WILDE nasal forceps, 90° upward, 3.6mm, size 2, WL 11cm</i>
<b>LC-002-124-SS</b>	BLAKESLEY-WILDE Nasenzange, 90° aufgebogen, 4.0mm, Größe 3, AL 11cm <i>BLAKESLEY-WILDE nasal forceps, 90° upward, 4.0mm, size 3, WL 11cm</i>
<b>LC-018-001-SS</b>	STRÜMPEL Nasenzange, gerade, 2.5mm <i>STRÜMPEL nasal cutting forceps, straight 2.5mm</i>

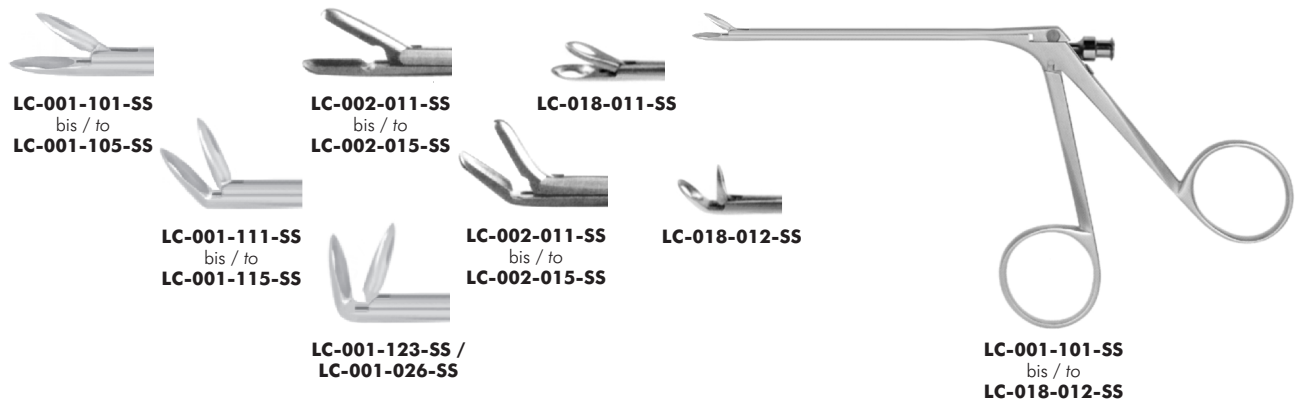

Bestell-Nr. Ordering no.	Bezeichnung Description
LC-001-101-SS	WEIL-BLAKESLEY Nasenzange, gerade, 2.5mm, mit Absaugung WEIL-BLAKESLEY nasal forceps, straight, 2.5mm, with suction channel
LC-001-102-SS	WEIL-BLAKESLEY Nasenzange, gerade, 3.0mm, mit Absaugung WEIL-BLAKESLEY nasal forceps, straight, 3.0mm, with suction channel
LC-001-103-SS	WEIL-BLAKESLEY Nasenzange, gerade, 3.6mm, mit Absaugung WEIL-BLAKESLEY nasal forceps, straight, 3.6mm, with suction channel
LC-001-104-SS	WEIL-BLAKESLEY Nasenzange, gerade, 4.2mm, mit Absaugung WEIL-BLAKESLEY nasal forceps, straight, 4.2mm, with suction channel
LC-001-105-SS	WEIL-BLAKESLEY Nasenzange, gerade, 4.8mm, mit Absaugung WEIL-BLAKESLEY nasal forceps, straight, 4.8mm, with suction channel
LC-001-111-SS	WEIL-BLAKESLEY Nasenzange, 45° aufgebogen, 2.5mm, mit Absaugung WEIL-BLAKESLEY nasal forceps, 45° upward, 2.5mm, with suction channel
LC-001-113-SS	WEIL-BLAKESLEY Nasenzange, 45° aufgebogen, 3.6mm, mit Absaugung WEIL-BLAKESLEY nasal forceps, 45° upward, 3.6mm, with suction channel
LC-001-115-SS	WEIL-BLAKESLEY Nasenzange, 45° aufgebogen, 4.8mm, mit Absaugung WEIL-BLAKESLEY nasal forceps, 45° upward, 4.8mm, with suction channel
LC-001-123-SS	WEIL-BLAKESLEY Nasenzange, 90° aufgebogen, 3.6mm, mit Absaugung WEIL-BLAKESLEY nasal forceps, 90° upward, 3.6mm, with suction channel
LC-001-133-SS	WEIL-BLAKESLEY Nasenzange, langes Maul, 90° aufgebogen, 3.6mm, mit Absaugung WEIL-BLAKESLEY nasal forceps, long jaw, 90° upward, 3.6mm, with suction channel
LC-002-011-SS	TAKAHASHI Nasenzange 2 x 10mm, gerade, mit Absaugung TAKAHASHI nasal forceps 2 x 10mm, straight, with suction channel
LC-002-012-SS	TAKAHASHI Nasenzange 3 x 10mm, gerade, mit Absaugung TAKAHASHI nasal forceps 3 x 10mm, straight, with suction channel
LC-002-013-SS	TAKAHASHI Nasenzange 4 x 10mm, gerade, mit Absaugung TAKAHASHI nasal forceps 4 x 10mm, straight, with suction channel
LC-002-014-SS	TAKAHASHI Nasenzange 2 x 10mm, 45° aufgebogen, mit Absaugung TAKAHASHI nasal forceps 2 x 10mm, 45° upward, with suction channel
LC-002-015-SS	TAKAHASHI Nasenzange 3 x 10mm, 45° aufgebogen, mit Absaugung TAKAHASHI nasal forceps 3 x 10mm, 45° upward, with suction channel
LC-002-016-SS	TAKAHASHI Nasenzange 4 x 10mm, 45° aufgebogen, mit Absaugung TAKAHASHI nasal forceps 4 x 10mm, 45° upward, with suction channel
LC-018-011-SS	STRÜMPPEL Nasenzange, gerade, 2.5mm, mit Absaugung STRÜMPPEL nasal cutting forceps, straight 2.5mm, with suction channel
LC-018-012-SS	STRÜMPPEL Nasenzange, 45° aufgebogen, 2.5mm, mit Absaugung STRÜMPPEL nasal cutting forceps, 45° upward, 2.5mm, with suction channel



LC-001-201 /  
LC-001-202



LC-002-201 /  
LC-002-202



LC-001-211 /  
LC-001-212



LC-002-211 /  
LC-002-212



LC-001-201  
bis / to  
LC-002-212

Bestell-Nr. Ordering no.	Bezeichnung Description
LC-001-201	WEIL-BLAKESLEY Nasenzange mit integriertem Saugkanal, gerade, 2.5mm WEIL-BLAKESLEY nasal forceps with integrated suction channel, straight, 2.5mm
LC-001-202	WEIL-BLAKESLEY Nasenzange mit integriertem Saugkanal, gerade, 4.0mm WEIL-BLAKESLEY nasal forceps with integrated suction channel, straight, 4.0mm
LC-001-211	WEIL-BLAKESLEY Nasenzange mit integriertem Saugkanal, 45° aufgebogen, 2.5mm WEIL-BLAKESLEY nasal forceps with integrated suction channel, 45° up curved, 2.5mm
LC-001-212	WEIL-BLAKESLEY Nasenzange mit integriertem Saugkanal, 45° aufgebogen, 4.0mm WEIL-BLAKESLEY nasal forceps with integrated suction channel, 45° up curved, 4.0mm
LC-002-201	TAKAHASHI Nasenzange mit integriertem Saugkanal, gerade, 2.5mm TAKAHASHI nasal forceps with integrated suction channel, straight, 2.5mm
LC-002-202	TAKAHASHI Nasenzange mit integriertem Saugkanal, gerade, 4.0mm TAKAHASHI nasal forceps with integrated suction channel, straight, 4.0mm
LC-002-211	TAKAHASHI Nasenzange mit integriertem Saugkanal, 45° aufgebogen, 2.5mm TAKAHASHI nasal forceps with integrated suction channel, 45° up curved, 2.5mm
LC-002-212	TAKAHASHI Nasenzange mit integriertem Saugkanal, 45° aufgebogen, 4.0mm TAKAHASHI nasal forceps with integrated suction channel, 45° up curved, 4.0mm



**LC-006-060**  
bis / to  
**LC-006-063 /**  
**LC-019-020**  
Bis / to  
**LC-019-023**



**LC-011-001**  
bis / to  
**LC-012-001**



**LC-013-001**  
bis / to  
**LC-013-003**



**LC-019-001**  
bis / to  
**LC-019-005**

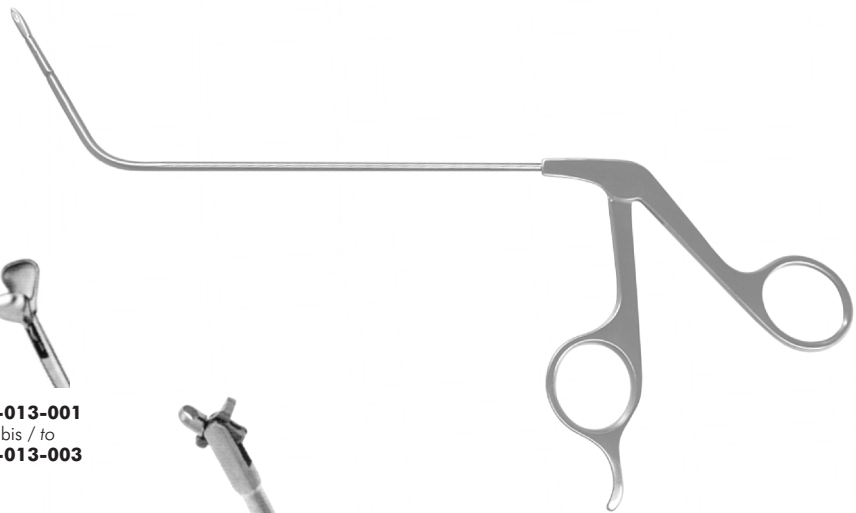

**LC-006-060**  
bis / to  
**LC-019-023**

<b>Bestell-Nr.</b> <b>Ordering no.</b>	<b>Bezeichnung</b> <b>Description</b>
<b>LC-006-060</b>	HEUWIESER Kieferhöhlen-Fasszange, 90° aufgebogen, AL 13cm <i>HEUWIESER antrum grasping forceps, 90° upcurved, WL 13cm</i>
<b>LC-006-061</b>	HEUWIESER Kieferhöhlen-Fasszange, 90° abgebogen, AL 13cm <i>HEUWIESER antrum grasping forceps, 90° downcurved, WL 13cm</i>
<b>LC-006-062</b>	HEUWIESER Kieferhöhlen-Fasszange, 90° nach rechts gebogen, AL 13cm <i>HEUWIESER antrum grasping forceps, 90° curved right, WL 13cm</i>
<b>LC-006-063</b>	HEUWIESER Kieferhöhlen-Fasszange, 90° nach links gebogen, AL 13cm <i>HEUWIESER antrum grasping forceps, 90° curved left, WL 13cm</i>
<b>LC-011-001</b>	Probeexcisions- und Faßzange, gerade, doppelbeweglich, Ø 2.5mm, NL 15cm <i>Biopsy and grasping forceps, straight, double action jaw, Ø 2.5mm, WL 15cm</i>
<b>LC-011-002</b>	Probeexcisions- und Faßzange, gerade, doppelbeweglich, vertikal öffnend, Ø 4mm, NL 18cm <i>Biopsy and grasping forceps, straight, double action jaw, vertical opening, Ø 4mm, WL 18cm</i>
<b>LC-012-001</b>	Kieferhöhlen-Probeexcisionszange, 120° rückwärts öffnend, oval, doppelbeweglich <i>Maxillary biopsy forceps, 120° retrograde, oval, double action jaw</i>
<b>LC-013-001</b>	BINNER Polypenfaßzange, birnenförmiges Maul, 3x1.5mm, Schaft 80° nach oben gebogen, horizontal öffnend <i>BINNER polyp grasping forceps, pear shaped tip, 3x1.5mm, sheath 80° upward, horizontal opening</i>
<b>LC-013-002</b>	BINNER Polypenfaßzange, birnenförmiges Maul, 3x1.5mm, Schaft 80° nach links gebogen, horizontal öffnend <i>BINNER polyp grasping forceps, pear shaped tip, 3x1.5mm, sheath 80° left, horizontal opening</i>
<b>LC-013-003</b>	BINNER Polypenfaßzange, birnenförmiges Maul, 3x1.5mm, Schaft 80° nach rechts gebogen, horizontal öffnend <i>BINNER polyp grasping forceps, pear shaped tip, 3x1.5mm, sheath 80° right, horizontal opening</i>
<b>LC-019-001</b>	Zange gerade vertikal, durchschneidend, Ø 2mm <i>Forceps straight vertical, cutting through, Ø 2mm</i>
<b>LC-019-002</b>	Zange 70° aufgebogen vertikal, durchschneidend, Ø 2mm <i>Forceps 70° upward vertical, cutting through, Ø 2mm</i>
<b>LC-019-003</b>	Zange kurz 70° aufgebogen vertikal, durchschneidend, Ø 2mm <i>Forceps short 70° upward vertical, cutting through, Ø 2mm</i>
<b>LC-019-004</b>	Zange 70° aufgebogen horizontal, rechts öffnend, Ø 2mm <i>Forceps 70° upward horizontal, opening right, Ø 2mm</i>
<b>LC-019-005</b>	Zange 70° aufgebogen horizontal, links öffnend, Ø 2mm <i>Forceps 70° upward horizontal, opening left, Ø 2mm</i>
<b>LC-019-020</b>	JATHO Nasenrachenzange, genfestertes Löffelmaul, Ø 3mm, Schaft 45° nach oben gebogen, NL 15cm <i>JATHO epipharyngeal forceps, fenestrated spoon jaws, Ø 3mm, shaft 45° upturned, WL 15cm</i>
<b>LC-019-021</b>	JATHO Nasenrachenzange, genfestertes Löffelmaul, Ø 3mm, Schaft 70° nach oben gebogen, NL 15cm <i>JATHO epipharyngeal forceps, fenestrated spoon jaws, Ø 3mm, shaft 70° upturned, WL 15cm</i>
<b>LC-019-022</b>	JATHO Nasenrachenzange, genfestertes Löffelmaul, Ø 3mm, Schaft 110° nach oben gebogen, NL 15cm <i>JATHO epipharyngeal forceps, fenestrated spoon jaws, Ø 3mm, shaft 110° upturned, WL 15cm</i>
<b>LC-019-023</b>	JATHO Nasenrachenzange, genfestertes Löffelmaul, Ø 3mm, Schaft gerade, NL 15cm <i>JATHO epipharyngeal forceps, fenestrated spoon jaws, Ø 3mm, shaft straight, WL 15cm</i>



**LC-008-001**  
bis / to  
**LC-008-061**



**LC-008-001**  
bis / to  
**LC-008-061**

<b>Bestell-Nr. Ordering no.</b>	<b>Bezeichnung Description</b>
<b>LC-008-001</b>	Biopsiezange gerade vertikal, oval, doppelbeweglich, Ø 3mm <i>Biopsy forceps straight vertical, oval, double action, Ø 3mm</i>
<b>LC-008-002</b>	Biopsiezange gerade horizontal, oval, doppelbeweglich, Ø 3mm, <i>Biopsy forceps straight horizontal, oval, double action, Ø 3mm</i>
<b>LC-008-011</b>	Biopsiezange 55° aufgebogen vertikal, oval, doppelbeweglich, Ø 3mm <i>Biopsy forceps 55° upward vertical, oval, double action, Ø 3mm</i>
<b>LC-008-012</b>	Biopsiezange 55° aufgebogen horizontal, oval, doppelbeweglich, Ø 3mm <i>Biopsy forceps 55° upward horizontal, oval, double action, Ø 3mm</i>
<b>LC-008-021</b>	Biopsiezange 70° aufgebogen vertikal, oval, doppelbeweglich, Ø 3mm <i>Biopsy forceps 70° upward vertical, oval, double action, Ø 3mm</i>
<b>LC-008-022</b>	Biopsiezange 70° aufgebogen horizontal, oval, doppelbeweglich, Ø 3mm <i>Biopsy forceps 70° upward horizontal, oval, double action, Ø 3mm</i>
<b>LC-008-031</b>	Biopsiezange 110° aufgebogen vertikal, oval, doppelbeweglich, Ø 3mm <i>Biopsy forceps 110° upward vertical, oval, double action, Ø 3mm</i>
<b>LC-008-032</b>	Biopsiezange 110° aufgebogen horizontal, oval, doppelbeweglich, Ø 3mm <i>Biopsy forceps 110° upward horizontal, oval, double action, Ø 3mm</i>
<b>LC-008-041</b>	Biopsiezange 70° aufgebogen vertikal, oval, doppelbeweglich, Ø 4mm <i>Biopsy forceps 70° upward vertical, oval, double action, Ø 4mm</i>
<b>LC-008-042</b>	Biopsiezange 70° aufgebogen horizontal, oval, doppelbeweglich, Ø 4mm <i>Biopsy forceps 70° upward horizontal, oval, double action, Ø 4mm</i>
<b>LC-008-051</b>	Biopsiezange 110° aufgebogen vertikal, oval, doppelbeweglich, Ø 4mm <i>Biopsy forceps 110° upward vertical, oval, double action, Ø 4mm</i>
<b>LC-008-052</b>	Biopsiezange 110° aufgebogen horizontal, oval, doppelbeweglich, Ø 4mm <i>Biopsy forceps 110° upward horizontal, oval, double action, Ø 4mm</i>
<b>LC-008-061</b>	Biopsiezange 45° aufgebogen vertikal, oval, doppelbeweglich, Ø 4mm <i>Biopsy forceps 45° upward vertical, oval, double action, Ø 4mm</i>





**LC-008-102**  
bis / to  
**LC-009-022**



**LC-008-102**  
bis / to  
**LC-009-022**

<b>Bestell-Nr.</b> <b>Ordering no.</b>	<b>Bezeichnung</b> <b>Description</b>
<b>LC-008-102</b>	Biopsiezange gerade horizontal, oval, einfachbeweglich, Ø 3mm <i>Biopsy forceps straight horizontal, oval, single action, Ø 3mm</i>
<b>LC-008-111</b>	Biopsiezange kurz 45° aufgebogen vertikal, oval, einfachbeweglich, Ø 3mm <i>Biopsy forceps short 45° upward vertical, oval, single action, Ø 3mm</i>
<b>LC-008-121</b>	Biopsiezange kurz 70° aufgebogen vertikal, oval, einfachbeweglich, Ø 3mm <i>Biopsy forceps short 70° upward vertical, oval, single action, Ø 3mm</i>
<b>LC-008-122</b>	Biopsiezange kurz 70° aufgebogen horizontal, oval, einfachbeweglich, Ø 3mm <i>Biopsy forceps short 70° upward horizontal, oval, single action, Ø 3mm</i>
<b>LC-008-141</b>	Biopsiezange 70° aufgebogen vertikal, oval, einfachbeweglich, Ø 4mm <i>Biopsy forceps 70° upward vertical, oval, single action, Ø 4mm</i>
<b>LC-008-142</b>	Biopsiezange kurz 70° aufgebogen horizontal, oval, doppelbeweglich, Ø 4mm <i>Biopsy forceps short 70° upward horizontal, oval, double action, Ø 4mm</i>
<b>LC-008-161</b>	Biopsiezange kurz 45° aufgebogen vertikal, oval, einfachbeweglich, Ø 4mm <i>Biopsy forceps short 45° upward vertical, oval, single action, Ø 4mm</i>
<b>LC-008-241</b>	Biopsiezange kurz 70° aufgebogen vertikal, oval, einfachbeweglich, Ø 4mm <i>Biopsy forceps short 70° upward vertical, oval, single action, Ø 4mm</i>
<b>LC-009-001</b>	Biopsiezange gerade vertikal, oval, doppelbeweglich, Ø 2mm <i>Biopsy forceps straight vertical, oval, double action, Ø 2mm</i>
<b>LC-009-002</b>	Biopsiezange gerade horizontal, oval, doppelbeweglich, Ø 2mm <i>Biopsy forceps straight horizontal, oval, double action, Ø 2mm</i>
<b>LC-009-011</b>	Biopsiezange 55° aufgebogen vertikal, oval, doppelbeweglich, Ø 2mm <i>Biopsy forceps 55° upward vertical, oval, double action, Ø 2mm</i>
<b>LC-009-012</b>	Biopsiezange 55° aufgebogen horizontal, oval, doppelbeweglich, Ø 2mm <i>Biopsy forceps 55° upward horizontal, oval, double action, Ø 2mm</i>
<b>LC-009-021</b>	Biopsiezange 90° aufgebogen vertikal, oval, doppelbeweglich, Ø 2mm <i>Biopsy forceps 90° upward vertical, oval, double action, Ø 2mm</i>
<b>LC-009-022</b>	Biopsiezange 90° aufgebogen horizontal, oval, doppelbeweglich, Ø 2mm <i>Biopsy forceps 90° upward horizontal, oval, double action, Ø 2mm</i>

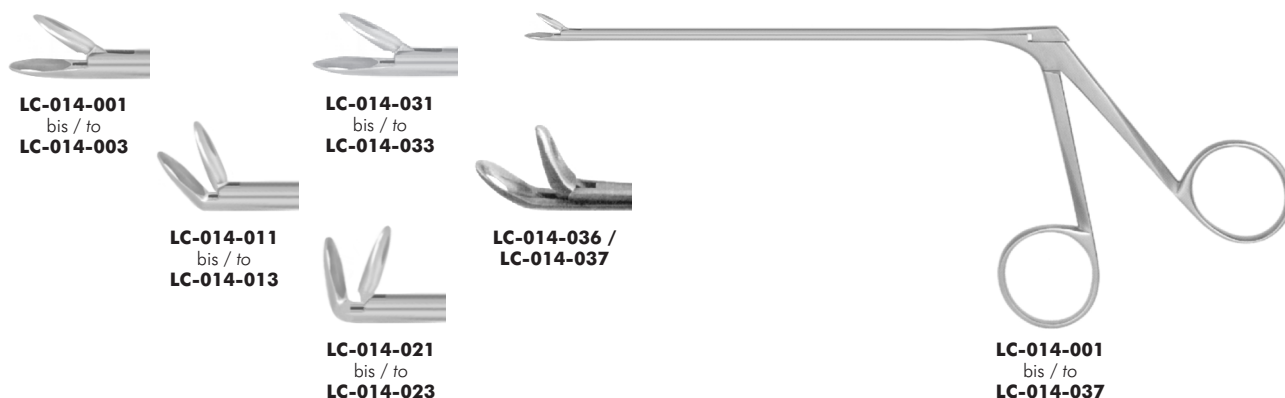

Bestell-Nr. Ordering no.	Bezeichnung Description
LC-014-001	Siebbeinzängchen gerade, Arbeitslänge 13cm <i>Ethmoid forceps straight, working length 13cm</i>
LC-014-002	Siebbeinzängchen gerade, Arbeitslänge 16cm <i>Ethmoid forceps straight, working length 16cm</i>
LC-014-003	Siebbeinzängchen gerade, Arbeitslänge 19cm <i>Ethmoid forceps straight, working length 19cm</i>
LC-014-011	Siebbeinzängchen 60° aufgebogen, Arbeitslänge 13cm <i>Ethmoid forceps 60° upward, working length 13cm</i>
LC-014-012	Siebbeinzängchen 60° aufgebogen, Arbeitslänge 16cm <i>Ethmoid forceps 60° upward, working length 16cm</i>
LC-014-013	Siebbeinzängchen 60° aufgebogen, Arbeitslänge 19cm <i>Ethmoid forceps 60° upward, working length 19cm</i>
LC-014-021	Siebbeinzängchen 90° aufgebogen, Arbeitslänge 13cm <i>Ethmoid forceps 90° upward, working length 13cm</i>
LC-014-022	Siebbeinzängchen 90° aufgebogen, Arbeitslänge 16cm <i>Ethmoid forceps 90° upward, working length 16cm</i>
LC-014-023	Siebbeinzängchen 90° aufgebogen, Arbeitslänge 19cm <i>Ethmoid forceps 90° upward, working length 19cm</i>
LC-014-031	BLAKESLEY Siebbeinzange gerade, Größe 0, Arbeitslänge 17cm <i>BLAKESLEY ethmoid forceps straight, size 0, working length 17cm</i>
LC-014-032	BLAKESLEY Siebbeinzange gerade, Größe 1, Arbeitslänge 17cm <i>BLAKESLEY ethmoid forceps straight, size 1, working length 17cm</i>
LC-014-033	BLAKESLEY Siebbeinzange gerade, Größe 2, Arbeitslänge 17cm <i>BLAKESLEY ethmoid forceps straight, size 2, working length 17cm</i>
LC-014-036	BLAKESLEY-WILDE Siebbeinzange 45° aufwärts gebogen, Größe 0, Arbeitslänge 17cm <i>BLAKESLEY-WILDE ethmoid forceps 45° upwards, size 0, working length 17cm</i>
LC-014-037	BLAKESLEY-WILDE Siebbeinzange 45° aufwärts gebogen, Größe 1, Arbeitslänge 17cm <i>BLAKESLEY-WILDE ethmoid forceps 45° upwards, size 1, working length 17cm</i>



**LC-006-001**  
bis / to  
**LC-006-103**



**LC-020-001**



**LC-020-002**

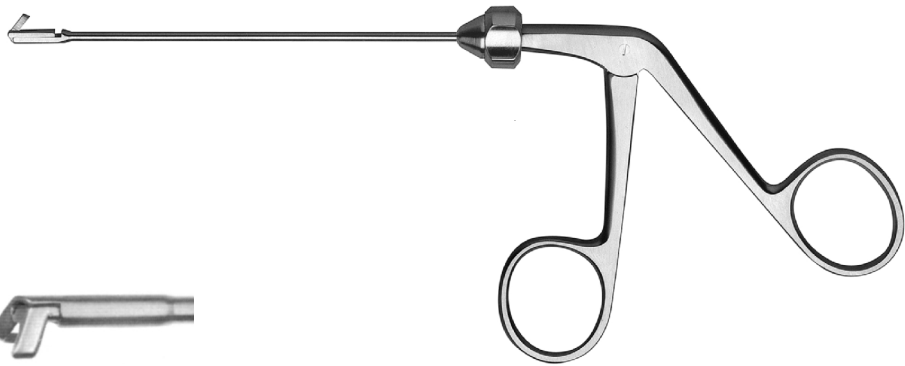

**LC-006-001**  
bis / to  
**LC-020-002**

<b>Bestell-Nr.</b> <b>Ordering no.</b>	<b>Bezeichnung</b> <b>Description</b>
<b>LC-006-001</b>	Antrumstanze "Backbiter", nach oben rückwärts schneidend, 2.5x6.5mm <i>Antrum punch "Backbiter", upward backward cutting, 2.5x6.5mm</i>
<b>LC-006-002</b>	Antrumstanze "Backbiter", nach links rückwärts schneidend, 2.5x6.5mm <i>Antrum punch "Backbiter", backward left cutting, 2.5x6.5mm</i>
<b>LC-006-003</b>	Antrumstanze "Backbiter", nach rechts rückwärts schneidend, 2.5x6.5mm <i>Antrum punch "Backbiter", backward right cutting, 2.5x6.5mm</i>
<b>LC-006-004</b>	Antrumstanze "Backbiter", nach unten rückwärts schneidend, 2.5x6.5mm <i>Antrum punch "Backbiter", backward downward cutting, 2.5x6.5mm</i>
<b>LC-006-005</b>	Antrumstanze "Backbiter", rotierend, rückwärts schneidend, 2.5x6.5mm <i>Antrum punch "Backbiter", rotatable, backward cutting, 2.5x6.5mm</i>
<b>LC-006-011</b>	Antrumstanze "Backbiter" Ø 3.5mm, nach oben rückwärts schneidend, 2.0x5.0mm <i>Antrum punch "Backbiter" Ø 3.5mm, upward backward cutting, 2.0x5.0mm</i>
<b>LC-006-012</b>	Antrumstanze "Backbiter" Ø 3.5mm, nach links rückwärts schneidend, 2.0x5.0mm <i>Antrum punch "Backbiter" Ø 3.5mm, backward left cutting, 2.0x5.0mm</i>
<b>LC-006-013</b>	Antrumstanze "Backbiter" Ø 3.5mm, nach rechts rückwärts schneidend, 2.0x5.0mm <i>Antrum punch "Backbiter" Ø 3.5mm, backward right cutting, 2.0x5.0mm</i>
<b>LC-006-014</b>	Antrumstanze "Backbiter" Ø 3.5mm, nach unten rückwärts schneidend, 2.0x5.0mm <i>Antrum punch "Backbiter" Ø 3.5mm, backward downward cutting, 2.0x5.0mm</i>
<b>LC-006-015</b>	Antrumstanze "Backbiter" Ø 3.5mm, rotierend, rückwärts schneidend, 2.0x5.0mm <i>Antrum punch "Backbiter" Ø 3.5mm, rotatable, backward cutting, 2.0x5.0mm</i>
<b>LC-006-021</b>	Antrumstanze "Backbiter" Ø 3.0mm, nach oben rückwärts schneidend, 1.5x3.5mm <i>Antrum punch "Backbiter" Ø 3.0mm, upward backward cutting, 1.5x3.5mm</i>
<b>LC-006-022</b>	Antrumstanze "Backbiter" Ø 3.0mm, nach links rückwärts schneidend, 1.5x3.5mm <i>Antrum punch "Backbiter" Ø 3.0mm, backward left cutting, 1.5x3.5mm</i>
<b>LC-006-023</b>	Antrumstanze "Backbiter" Ø 3.0mm, nach rechts rückwärts schneidend, 1.5x3.5mm <i>Antrum punch "Backbiter" Ø 3.0mm, backward right cutting, 1.5x3.5mm</i>
<b>LC-006-024</b>	Antrumstanze "Backbiter" Ø 3.0mm, nach unten rückwärts schneidend, 1.5x3.5mm <i>Antrum punch "Backbiter" Ø 3.0mm, backward downward cutting, 1.5x3.5mm</i>
<b>LC-006-025</b>	Antrumstanze "Backbiter" Ø 3.0mm, rotierend, rückwärts schneidend, 1.5x3.5mm <i>Antrum punch "Backbiter" Ø 3.0mm, rotatable, backward cutting, 1.5x3.5mm</i>
<b>LC-006-101</b>	Antrumstanze "Backbiter", nach oben rückwärts schneidend, schlankes Modell <i>Antrum punch "Backbiter", upward backward cutting, slim model</i>
<b>LC-006-102</b>	Antrumstanze "Backbiter", nach links rückwärts schneidend, schlankes Modell <i>Antrum punch "Backbiter", backward left cutting, slim model</i>
<b>LC-006-103</b>	Antrumstanze "Backbiter", nach rechts rückwärts schneidend, schlankes Modell <i>Antrum punch "Backbiter", backward right cutting, slim model</i>
<b>LC-020-001</b>	STEMA ANTRUM, seitlich nach rechts und vorwärts schneidend, AL 10cm <i>STEMA ANTRUM, sideward right and towards cutting, WL 10cm</i>
<b>LC-020-002</b>	STEMA ANTRUM, seitlich nach links und vorwärts schneidend, AL 10cm <i>STEMA ANTRUM, sideward left and towards cutting, WL 10cm</i>



**LC-006-041**  
bis / to  
**LC-006-043**

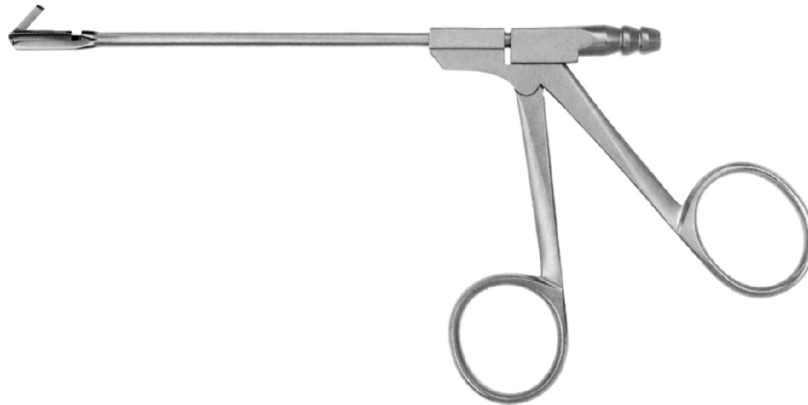

**LC-006-041**  
bis / to  
**LC-006-043**

<b>Bestell-Nr.</b> <b>Ordering no.</b>	<b>Bezeichnung</b> <b>Description</b>
<b>LC-006-041</b>	Antrumstanze "Backbiter" mit integriertem Absaugkanal, nach oben rückwärts schneidend, 2mm, Schaft Ø 4.5mm <i>Antrum punch "Backbiter" with integrated suction channel, upward backward cutting, 2mm, sheath Ø 4.5mm</i>
<b>LC-006-042</b>	Antrumstanze "Backbiter" mit integriertem Absaugkanal, nach links rückwärts schneidend, 2mm, Schaft Ø 4.5mm <i>Antrum punch "Backbiter" with integrated suction channel, backward left cutting, 2mm, sheath Ø 4.5mm</i>
<b>LC-006-043</b>	Antrumstanze "Backbiter" mit integriertem Absaugkanal, nach rechts rückwärts schneidend, 2mm, Schaft Ø 4.5mm <i>Antrum punch "Backbiter" with integrated suction channel, backward right cutting, 2mm, sheath Ø 4.5mm</i>

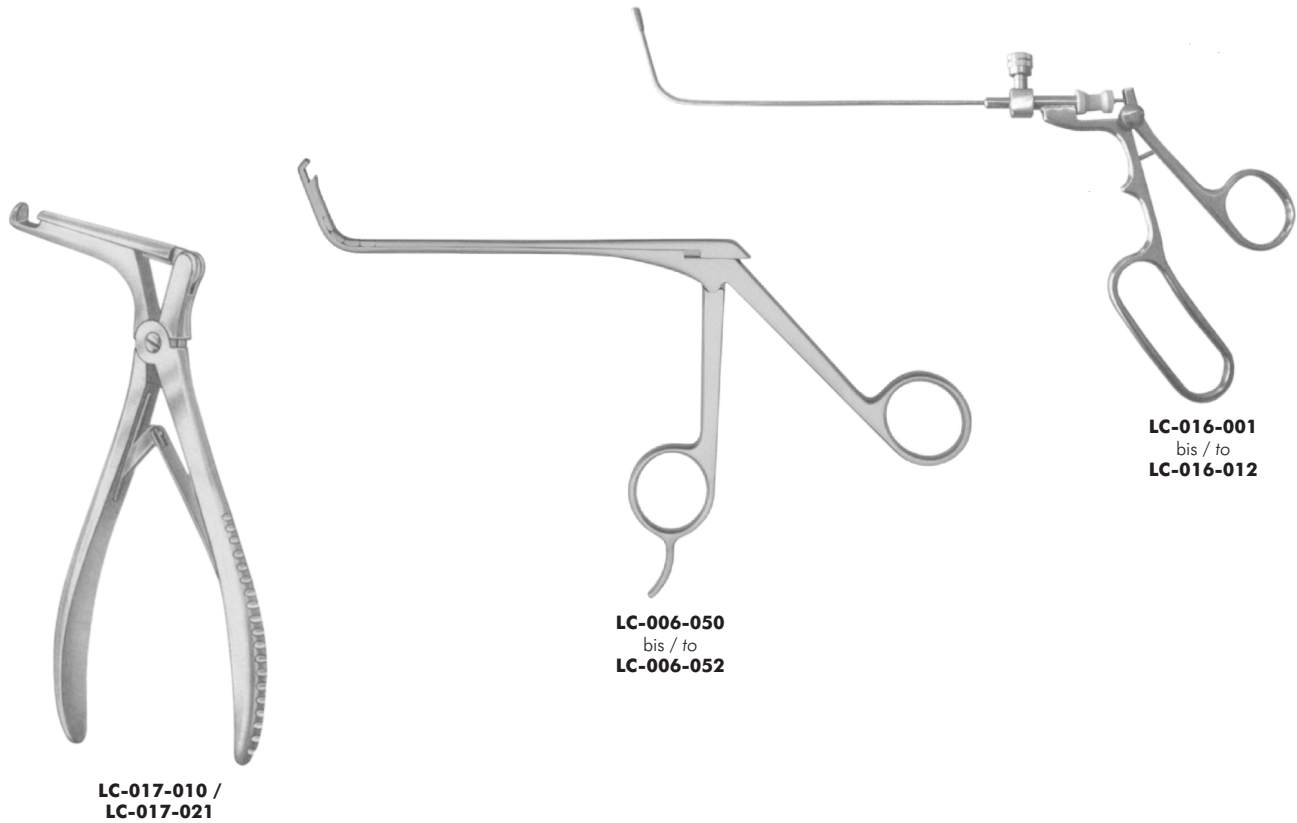

Bestell-Nr. Ordering no.	Bezeichnung Description
<b>LC-006-050</b>	Frontal Ostiumstanze, Gliederzange, 70° aufgebogen, schmal, 2x2.5mm, AL 13cm Frontal sinus punch, link chain system, 70° upcurved, small, 2x2.5mm, WL 13cm
<b>LC-006-051</b>	Frontal Ostiumstanze, Gliederzange, 70° aufgebogen, schmal, 3x3.5mm, AL 13cm Frontal sinus punch, link chain system, 70° upcurved, small, 3x3.5mm, WL 13cm
<b>LC-006-052</b>	Frontal Ostiumstanze, Gliederzange, 70° aufgebogen, schmal, 5x5.5mm, AL 13cm Frontal sinus punch, link chain system, 70° upcurved, small, 5x5.5mm, WL 13cm
<b>LC-016-001</b>	Rundkopfstanze, 360° zirkular schneidend, Ø 3.5mm, Arbeitslänge 18cm Circular cutting punch, cutting in a circle of 360°, Ø 3.5mm, working length 18cm
<b>LC-016-002</b>	Rundkopfstanze, 360° zirkular schneidend, Ø 4.5mm, Arbeitslänge 18cm Circular cutting punch, cutting in a circle of 360°, Ø 4.5mm, working length 18cm
<b>LC-016-011</b>	Rundkopfstanze 65° aufgewinkelt, 360° zirkular schneidend, Ø 3.5mm, Arbeitslänge 18cm Circular cutting punch 65° upward, cutting in a circle of 360°, Ø 3.5mm, working length 18cm
<b>LC-016-012</b>	Rundkopfstanze 65° aufgewinkelt, 360° zirkular schneidend, Ø 4.5mm, Arbeitslänge 18cm Circular cutting punch 65° upward, cutting in a circle of 360°, Ø 4.5mm, working length 18cm
<b>LC-017-010</b>	Meißelstanze, 4mm, Arbeitslänge 4cm Chisel-edged punch, 4mm, working length 4cm
<b>LC-017-021</b>	Meißelstanze, 6mm, Arbeitslänge 4cm Chisel-edged punch, 6mm, working length 4cm

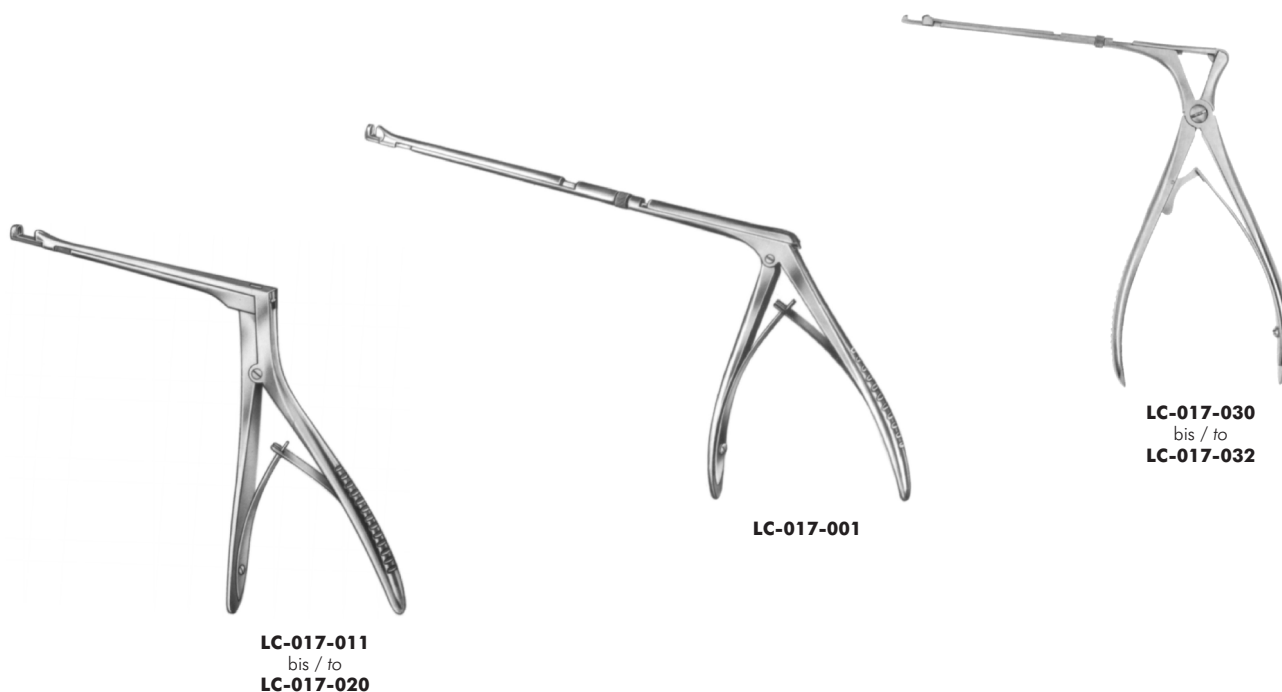

Bestell-Nr. Ordering no.	Bezeichnung Description
LC-017-001	HAJEK KOFFLER Knochenstanze, drehbar um 360°, durchschneidend, Arbeitslänge 18cm <i>HAJEK KOFFLER sphenoid punch, reversible 360°, cutting through, working length 18cm</i>
LC-017-011	HAJEK KOFFLER Keilbeinstanze 3.5x3.5mm, nach oben schneidend, Arbeitslänge 14cm <i>HAJEK KOFFLER sphenoid punch, 3.5x3.5mm, upbiting, working length 14cm</i>
LC-017-012	HAJEK KOFFLER Keilbeinstanze 3.5x3.5mm, nach unten schneidend, Arbeitslänge 14cm <i>HAJEK KOFFLER sphenoid punch, 3.5x3.5mm, downbiting, working length 14cm</i>
LC-017-013	HAJEK KOFFLER Keilbeinstanze 4x4mm, nach oben schneidend, Arbeitslänge 14cm <i>HAJEK KOFFLER sphenoid punch, 4x4mm, upbiting, working length 14cm</i>
LC-017-014	HAJEK KOFFLER Keilbeinstanze 4x4mm, nach unten schneidend, Arbeitslänge 14cm <i>HAJEK KOFFLER sphenoid punch, 4x4mm, downbiting, working length 14cm</i>
LC-017-015	HAJEK KOFFLER Keilbeinstanze 3.5x3.5mm, nach oben rückwärts schneidend, Arbeitslänge 14cm <i>HAJEK KOFFLER sphenoid punch, 3.5x3.5mm, upbiting backward, working length 14cm</i>
LC-017-016	HAJEK KOFFLER Keilbeinstanze 3.5x3.5mm, nach unten rückwärts schneidend, Arbeitslänge 14cm <i>HAJEK KOFFLER sphenoid punch, 3.5x3.5mm, downbiting backward, working length 14cm</i>
LC-017-017	HAJEK KOFFLER Keilbeinstanze 3.5x3.5mm, nach oben vorwärts schneidend, Arbeitslänge 14cm <i>HAJEK KOFFLER sphenoid punch, 3.5x3.5mm, upbiting forward, working length 14cm</i>
LC-017-018	HAJEK KOFFLER Keilbeinstanze 2x2mm, nach oben vorwärts schneidend, Arbeitslänge 14cm <i>HAJEK KOFFLER sphenoid punch, 2x2mm, upbiting forward, working length 14cm</i>
LC-017-019	HAJEK KOFFLER Keilbeinstanze 4.2x5.5mm, nach oben schneidend, Arbeitslänge 14cm <i>HAJEK KOFFLER sphenoid punch, 4.2x5.5mm, upbiting, working length 14cm</i>
LC-017-020	HAJEK KOFFLER Keilbeinstanze 4.2x5.5mm, nach oben vorwärts schneidend, Arbeitslänge 14cm <i>HAJEK KOFFLER sphenoid punch, 4.2x5.5mm, upbiting forward, working length 14cm</i>
LC-017-030	McKENTY Keilbeinstanze, drehbar um 360°, durchschneidend, 1.6x2mm, Arbeitslänge 12cm <i>McKENTY sphenoid punch, reversible 360°, cutting through, 1.6x2mm, working length 12cm</i>
LC-017-031	McKENTY Keilbeinstanze, drehbar um 360°, durchschneidend, 1.6x2mm, Arbeitslänge 17cm <i>McKENTY sphenoid punch, reversible 360°, cutting through, 1.6x2mm, working length 17cm</i>
LC-017-032	McKENTY CASTELNUOVO Keilbeinstanze, drehbar um 360°, durchschneidend, 30° aufgebogen, 1.6x2mm, AL 17cm <i>McKENTY CASTELNUOVO sphenoid punch, reversible 360°, cutting through, 30° up curved, 1.6x2mm, WL 17cm</i>

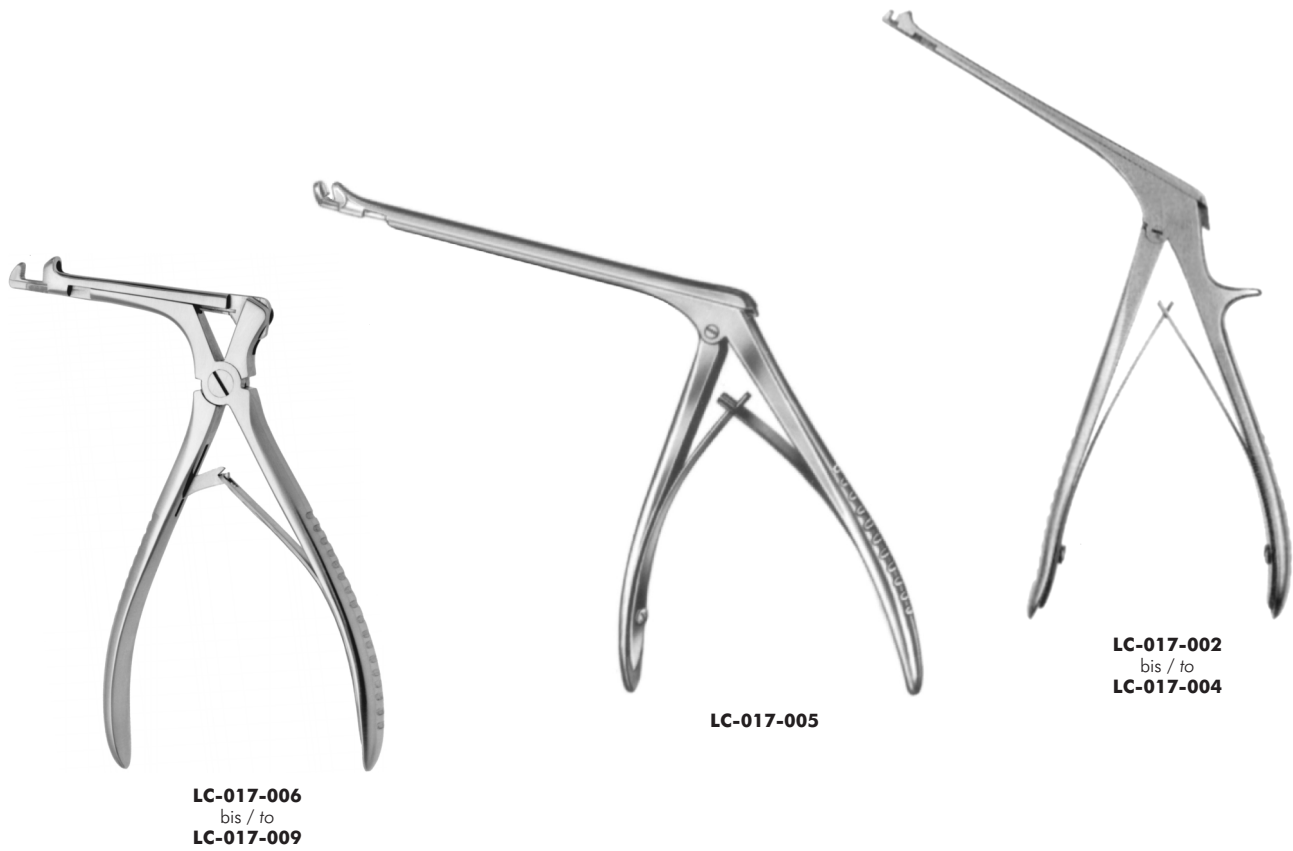

<b>Bestell-Nr.</b> <b>Ordering no.</b>	<b>Bezeichnung</b> <b>Description</b>
<b>LC-017-002</b>	BEYER Kieferhöhlenstanze, Arbeitslänge 14cm <i>BEYER antrum rongeur, working length 14cm</i>
<b>LC-017-003</b>	BEYER Kieferhöhlenstanze, durchschneidend, Arbeitslänge 9.5cm <i>BEYER antrum rongeur, cutting through, working length 9.5cm</i>
<b>LC-017-004</b>	BEYER Kieferhöhlenstanze, durchschneidend, Arbeitslänge 17cm <i>BEYER antrum rongeur, cutting through, working length 17cm</i>
<b>LC-017-005</b>	Kieferhöhlenstanze, 65° nach oben schneidend, Arbeitslänge 11cm <i>Antrum rongeur, 65° upbiting cutting, working length 11cm</i>
<b>LC-017-006</b>	CITELLI Kieferhöhlenstanze, durchschneidend, 1.5mm, Arbeitslänge 17cm <i>CITELLI antrum rongeur, cutting through, 1.5mm, working length 17cm</i>
<b>LC-017-007</b>	CITELLI Kieferhöhlenstanze, durchschneidend, Fig. 1, Arbeitslänge 8cm <i>CITELLI antrum rongeur, cutting through, fig. 1, working length 8cm</i>
<b>LC-017-008</b>	CITELLI Kieferhöhlenstanze, durchschneidend, Fig. 2, Arbeitslänge 8cm <i>CITELLI antrum rongeur, cutting through, fig. 2, working length 8cm</i>
<b>LC-017-009</b>	CITELLI Kieferhöhlenstanze, durchschneidend, Fig. 3, Arbeitslänge 8cm <i>CITELLI antrum rongeur, cutting through, fig. 3, working length 8cm</i>



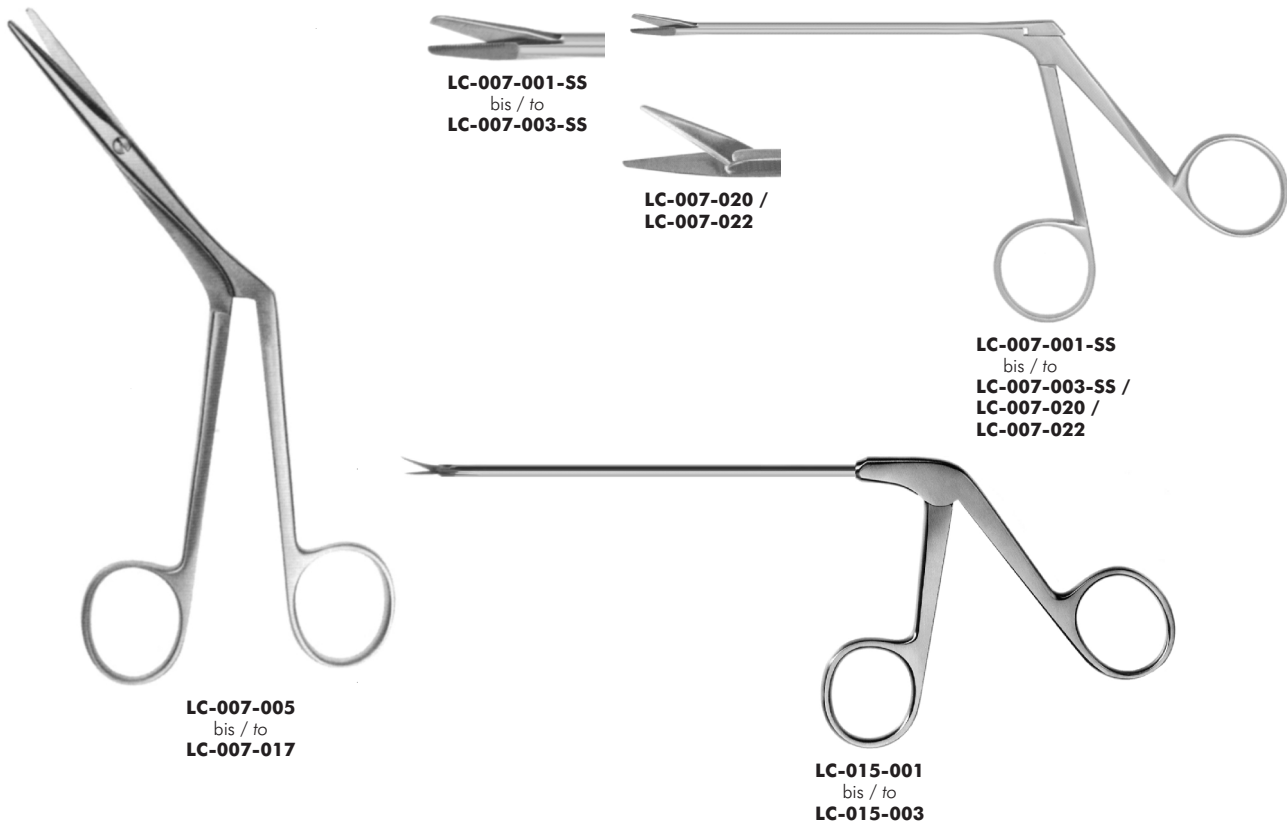

Bestell-Nr. Ordering no.	Bezeichnung Description
<b>LC-007-001-SS</b>	Nasenschere für Concha, gezahnte Schneiden, gerade <i>Nasal scissors, serrated blades, straight</i>
<b>LC-007-002-SS</b>	Nasenschere für Concha, gezahnte Schneiden, links gebogen <i>Nasal scissors, serrated blades, left curved</i>
<b>LC-007-003-SS</b>	Nasenschere für Concha, gezahnte Schneiden, rechts gebogen <i>Nasal scissors, serrated blades, right curved</i>
<b>LC-007-005</b>	HEYMANN Nasenschere, SC, AL 9.5cm <i>HEYMANN nasal scissors, SC, WL 9.5cm</i>
<b>LC-007-006</b>	HEYMANN Nasenschere, AL 9cm <i>HEYMANN nasal scissors, WL 9cm</i>
<b>LC-007-007</b>	HEYMANN Nasenschere, AL 9.5cm <i>HEYMANN nasal scissors, WL 9.5cm</i>
<b>LC-007-008</b>	HEYMANN Nasenschere, gezahnt, AL 9.5cm <i>HEYMANN nasal scissors, serrated, WL 9.5cm</i>
<b>LC-007-009</b>	HEYMANN Nasenschere, AL 11cm <i>HEYMANN nasal scissors, WL 11cm</i>
<b>LC-007-016</b>	HEYMANN Nasenschere, links gebogen, AL 9.5cm <i>HEYMANN nasal scissors, curved left, WL 9.5cm</i>
<b>LC-007-017</b>	HEYMANN Nasenschere, rechts gebogen, AL 9.5cm <i>HEYMANN nasal scissors, curved right, WL 9.5cm</i>
<b>LC-007-020</b>	ZÜRICH Nasenschere, gerade, NL 14cm <i>ZÜRICH nasal scissors, straight, WL 14cm</i>
<b>LC-007-022</b>	ZÜRICH Nasenschere, gerade, NL 12cm <i>ZÜRICH nasal scissors, straight, WL 12cm</i>
<b>LC-015-001</b>	Siebbeinscherchen gerade, Schiebeschäft, Arbeitslänge 13cm <i>Ethmoid scissors straight, sliding sheath, working length 13cm</i>
<b>LC-015-002</b>	Siebbeinscherchen gerade, Schiebeschäft, Arbeitslänge 16cm <i>Ethmoid scissors straight, sliding sheath, working length 16cm</i>
<b>LC-015-003</b>	Siebbeinscherchen gerade, Schiebeschäft, Arbeitslänge 16cm <i>Ethmoid scissors straight, sliding sheath, working length 16cm</i>





**STEMA**

Medizintechnik GmbH

**TONSILLEKTOMIE**

**TONSILLECTOMY**

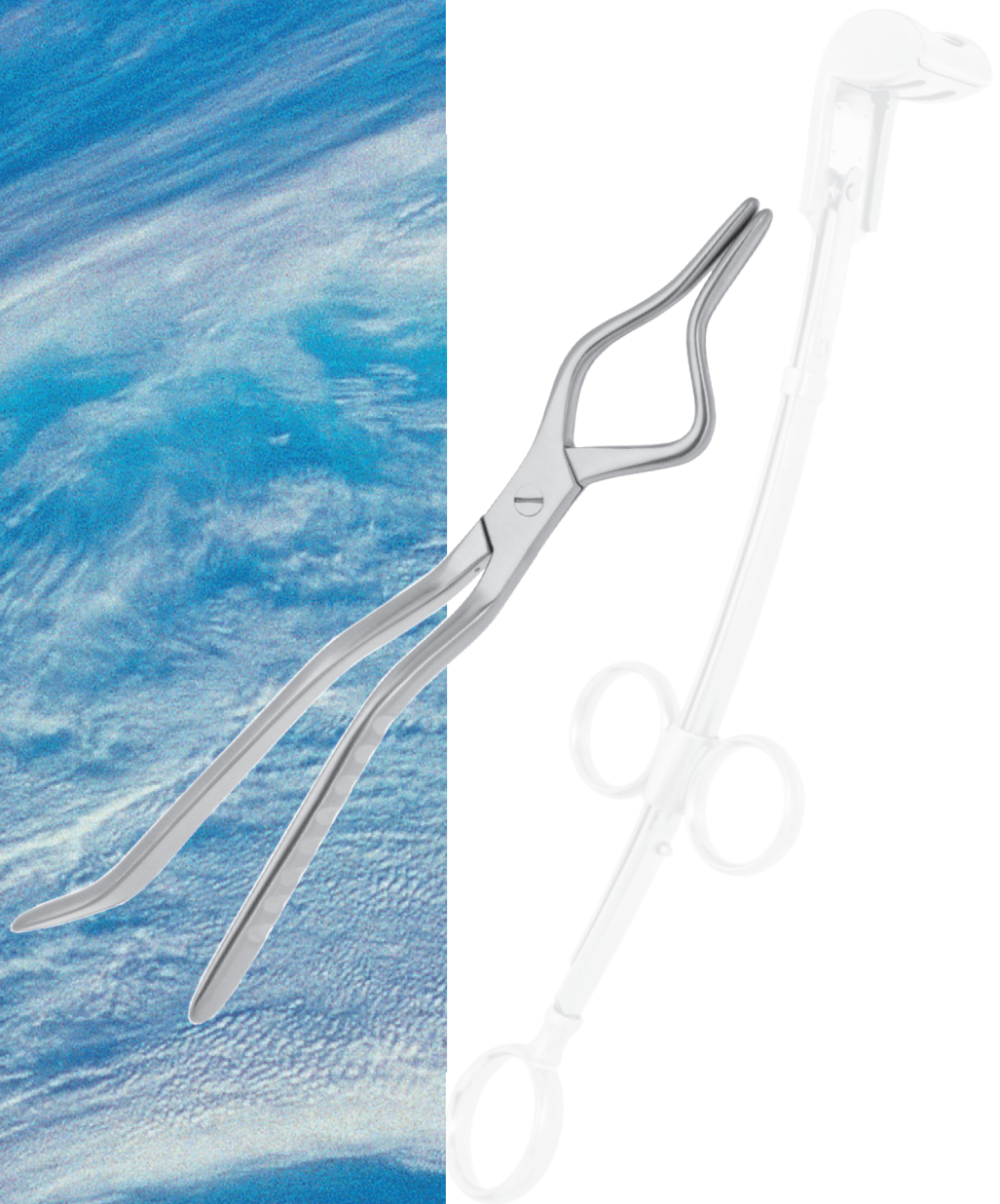





**ZA-003-240 /  
ZA-003-241**



**ZA-003-249**  
bis / to  
**ZA-003-253**



**ZA-003-248 /  
ZA-003-254**



**ZA-003-243**  
bis / to  
**ZA-003-245**

**ZA-003-246**

<b>Bestell-Nr. Ordering no.</b>	<b>Bezeichnung Description</b>
<b>ZA-003-240</b>	JENNINGS Mundsperrer, 11 cm <i>JENNINGS mouth gag, 11 cm</i>
<b>ZA-003-241</b>	JENNINGS Mundsperrer, 13cm <i>JENNINGS mouth gag, 13cm</i>
<b>ZA-003-242</b>	KILNER-DOUGHTY Mundsperrer, komplett <i>KILNER-DOUGHTY mouth gag, complete</i>
<b>ZA-003-243</b>	KILNER-DOUGHTY Zungenspatel, Fig. 1 <i>KILNER-DOUGHTY tongue depressor, fig. 1</i>
<b>ZA-003-244</b>	KILNER-DOUGHTY Zungenspatel, Fig. 2 <i>KILNER-DOUGHTY tongue depressor, fig. 2</i>
<b>ZA-003-245</b>	KILNER-DOUGHTY Zungenspatel, Fig. 3 <i>KILNER-DOUGHTY tongue depressor, fig. 3</i>
<b>ZA-003-246</b>	KILNER-DOUGHTY Mundsperrer, nur Rahmen <i>KILNER-DOUGHTY mouth gag, frame only</i>
<b>ZA-003-248</b>	DAVIS-BOYLE Mundsperrer, komplett <i>DAVIS-BOYLE mouth gag, complete</i>
<b>ZA-003-249</b>	DAVIS-BOYLE Zungendrucker, 105x27mm, Fig. 1 <i>DAVIS-BOYLE tongue depressor, 105x27mm, fig. 1</i>
<b>ZA-003-250</b>	DAVIS-BOYLE Zungendrucker, 90x25mm, Fig. 2 <i>DAVIS-BOYLE tongue depressor, 90x25mm, fig. 2</i>
<b>ZA-003-251</b>	DAVIS-BOYLE Zungendrucker, 75x25mm, Fig. 3 <i>DAVIS-BOYLE tongue depressor, 75x25mm, fig. 3</i>
<b>ZA-003-252</b>	DAVIS-BOYLE Zungendrucker, 60x22mm, Fig. 4 <i>DAVIS-BOYLE tongue depressor, 60x22mm, fig. 4</i>
<b>ZA-003-253</b>	DAVIS-BOYLE Zungendrucker, 25x20mm, Fig. 5 <i>DAVIS-BOYLE tongue depressor, 25x20mm, fig. 5</i>
<b>ZA-003-254</b>	DAVIS-BOYLE Mundsperrer, nur Rahmen <i>DAVIS-BOYLE mouth gag, frame only</i>





**ZA-004-572**  
bis / to  
**ZA-004-575**

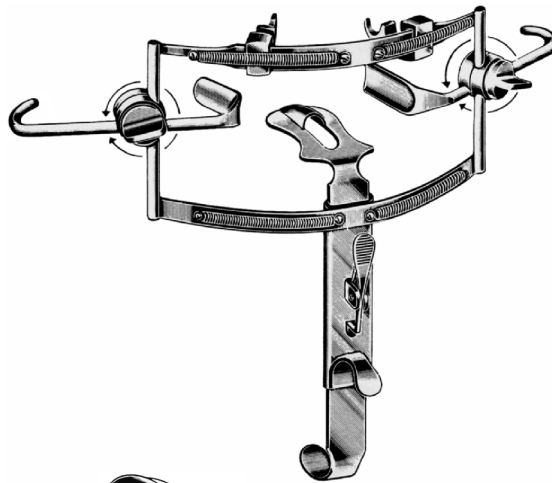

**ZA-004-576 /**  
**ZA-004-577**



**ZA-004-578**  
bis / to  
**ZA-004-580**



**ZA-004-568**

**ZA-004-569**  
bis / to  
**ZA-003-571**

Bestell-Nr. Ordering no.	Bezeichnung Description
<b>ZA-004-567</b>	MC IVOR Mundsperrer, komplett <i>MC IVOR mouth gag, complete</i>
<b>ZA-004-568</b>	MC IVOR Mundsperrer, nur Rahmen <i>MC IVOR mouth gag, frame only</i>
<b>ZA-004-569</b>	MC IVOR Zungenspatel, 75x23mm, Fig. 1 <i>MC IVOR tongue depressor, 75x23mm, fig. 1</i>
<b>ZA-004-570</b>	MC IVOR Zungenspatel, 85x25mm, Fig. 2 <i>MC IVOR tongue depressor, 85x25mm, fig. 2</i>
<b>ZA-004-571</b>	MC IVOR Zungenspatel, 100x26mm, Fig. 3 <i>MC IVOR tongue depressor, 100x26mm, fig. 3</i>
<b>ZA-004-572</b>	JENNINGS Mundsperrer, 9cm <i>JENNINGS mouth gag, 9cm</i>
<b>ZA-004-573</b>	JENNINGS Mundsperrer, 11cm <i>JENNINGS mouth gag, 11cm</i>
<b>ZA-004-574</b>	JENNINGS Mundsperrer, 13cm <i>JENNINGS mouth gag, 13cm</i>
<b>ZA-004-575</b>	JENNINGS Mundsperrer, 15cm <i>JENNINGS mouth gag, 15cm</i>
<b>ZA-004-576</b>	DINGMANN Mundsperrer, komplett <i>DINGMANN mouth gag, complete</i>
<b>ZA-004-577</b>	DINGMANN Mundsperrer, nur Rahmen <i>DINGMANN mouth gag, frame only</i>
<b>ZA-004-578</b>	DINGMANN Zungenspatel, 65x25mm, Fig. 1 <i>DINGMANN tongue depressor, 65x25mm, fig. 1</i>
<b>ZA-004-579</b>	DINGMANN Zungenspatel, 70x29mm, Fig. 2 <i>DINGMANN tongue depressor, 70x29mm, fig. 2</i>
<b>ZA-004-580</b>	DINGMANN Zungenspatel, 80x32mm, Fig. 3 <i>DINGMANN tongue depressor, 80x32mm, fig. 3</i>



**ZA-004-561**



**ZA-004-697 /  
 ZA-004-698 /  
 ZA-004-699**

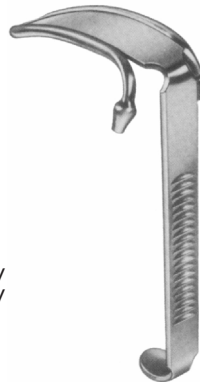

**ZA-004-700**  
 bis / to  
**ZA-004-706**



**ZA-003-256**  
 bis / to  
**ZA-003-258**

<b>Bestell-Nr. Ordering no.</b>	<b>Bezeichnung Description</b>
<b>ZA-003-256</b>	STERNBERG Lippenhalter, 12cm STERNBERG lip retractor 12cm
<b>ZA-003-257</b>	STERNBERG Lippenhalter, 14cm STERNBERG lip retractor 14cm
<b>ZA-003-258</b>	STERNBERG Lippenhalter, 16cm STERNBERG lip retractor 16cm
<b>ZA-004-561</b>	BUCHWALD Zungenspatel, 19cm BUCHWALD tongue depressor, 19cm
<b>ZA-004-697</b>	DAVIS-MEYER Mundsperrer, komplett DAVIS-MEYER mouth gag, complete
<b>ZA-004-698</b>	DAVIS-MEYER Mundsperrer, rechts, nur Rahmen DAVIS-MEYER mouth gag, right, frame only
<b>ZA-004-699</b>	DAVIS-MEYER Mundsperrer, links, nur Rahmen DAVIS-MEYER mouth gag, left, frame only
<b>ZA-004-700</b>	DAVIS-MEYER Zungenspatel, Fig. 1 DAVIS-MEYER tongue depressor, fig. 1
<b>ZA-004-701</b>	DAVIS-MEYER Zungenspatel, Fig. 2 DAVIS-MEYER tongue depressor, fig. 2
<b>ZA-004-702</b>	DAVIS-MEYER Zungenspatel, Fig. 3 DAVIS-MEYER tongue depressor, fig. 3
<b>ZA-004-703</b>	DAVIS-MEYER Zungenspatel, Fig. 4 DAVIS-MEYER tongue depressor, fig. 4
<b>ZA-004-704</b>	DAVIS-MEYER Zungenspatel, Fig. 5 DAVIS-MEYER tongue depressor, fig. 5
<b>ZA-004-705</b>	DAVIS-MEYER Zungenspatel, Fig. 6 DAVIS-MEYER tongue depressor, fig. 6
<b>ZA-004-706</b>	DAVIS-MEYER Zungenspatel, Fig. 7 DAVIS-MEYER tongue depressor, fig. 7





**ZA-004-562**



**ZA-003-264**



**ZA-003-263**



**LD-030-032**



**ZA-003-262**



**ZA-003-259**



**ZA-004-563**



**LD-030-033**

<b>Bestell-Nr.</b> <b>Ordering no.</b>	<b>Bezeichnung</b> <b>Description</b>
<b>LD-030-032</b>	FRENZEL Zungendrucker, 16.5cm <i>FRENZEL tongue depressor, 16.5cm</i>
<b>LD-030-033</b>	HARTMANN Zungendrucker, 15cm <i>HARTMANN tongue depressor, 15cm</i>
<b>ZA-003-259</b>	TOBOLD Zungendrucker, Hohlheftgriff, 14.5cm <i>TOBOLD tongue depressor, hollow handle, 14.5cm</i>
<b>ZA-003-262</b>	Zungendrucker, Standard S, 14.5cm <i>Tongue depressor, standard S, 14.5cm</i>
<b>ZA-003-263</b>	MAYO Zungendrucker, 17cm <i>MAYO tongue depressor, 17cm</i>
<b>ZA-003-264</b>	BRÜNING'S Zungendrucker, 19cm <i>BRÜNING'S tongue depressor, 19cm</i>
<b>ZA-004-562</b>	MORITZ-SCHMIDT Zungendrucker, 19cm <i>MORITZ-SCHMIDT tongue depressor, 19cm</i>
<b>ZA-004-563</b>	BOSWORTH Zungendrucker, glatt, 14.5cm <i>BOSWORTH tongue depressor, smooth, 14.5cm</i>



ZA-004-566



ZA-004-565



ZA-004-564

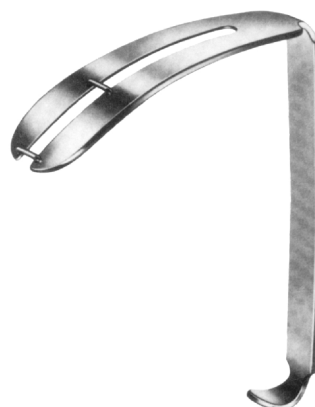

ZA-004-581  
bis / to  
ZA-004-585



ZA-004-586  
bis / to  
ZA-004-593

Bestell-Nr. Ordering no.	Bezeichnung Description
ZA-004-564	Zungendrucker, bajonettförmig, 14.5cm <i>Tongue depressor, bayonett shaped, 14.5cm</i>
ZA-004-565	KROENIG Zungendrucker, 15cm <i>KROENIG tongue depressor, 15cm</i>
ZA-004-566	FRENZEL Zungendrucker, 16.5cm <i>FRENZEL tongue depressor, 16.5cm</i>
ZA-004-581	WÜRZBURG Zungendrucker, 28x66mm, Fig. 1 <i>WÜRZBURG tongue depressor, 28x66mm, fig. 1</i>
ZA-004-582	WÜRZBURG Zungendrucker, 32x75mm, Fig. 2 <i>WÜRZBURG tongue depressor, 32x75mm, fig. 2</i>
ZA-004-583	WÜRZBURG Zungendrucker, 34x83mm, Fig. 3 <i>WÜRZBURG tongue depressor, 34x83mm, fig. 3</i>
ZA-004-584	WÜRZBURG Zungendrucker, 37x93mm, Fig. 4 <i>WÜRZBURG tongue depressor, 37x93mm, fig. 4</i>
ZA-004-585	WÜRZBURG Zungendrucker, 38x100mm, Fig. 5 <i>WÜRZBURG tongue depressor, 38x100mm, fig. 5</i>
ZA-004-586	RING Zungendrucker, 27x72mm, links, Fig. 2 <i>RING tongue depressor, 27x72mm, left, fig. 2</i>
ZA-004-587	RING Zungendrucker, 27x72mm, links, Fig. 3 <i>RING tongue depressor, 27x72mm, left, fig. 3</i>
ZA-004-588	RING Zungendrucker, 34x87mm, links, Fig. 4 <i>RING tongue depressor, 34x87mm, left, fig. 4</i>
ZA-004-589	RING Zungendrucker, 37x95mm, links, Fig. 5 <i>RING tongue depressor, 37x95mm, left, fig. 5</i>
ZA-004-590	RING Zungendrucker, 27x72mm, rechts, Fig. 2 <i>RING tongue depressor, 27x72mm, right, fig. 2</i>
ZA-004-591	RING Zungendrucker, 27x72mm, rechts, Fig. 3 <i>RING tongue depressor, 27x72mm, right, fig. 3</i>
ZA-004-592	RING Zungendrucker, 34x87mm, rechts, Fig. 4 <i>RING tongue depressor, 34x87mm, right, fig. 4</i>
ZA-004-593	RING Zungendrucker, 37x95mm, rechts, Fig. 5 <i>RING tongue depressor, 37x95mm, right, fig. 5</i>



**LJ-003-020**  
bis / to  
**LJ-003-023**

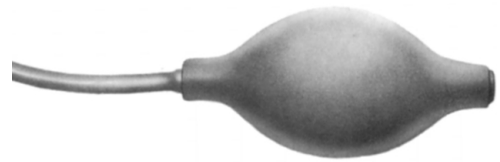

**LJ-003-024**

<b>Bestell-Nr. Ordering no.</b>	<b>Bezeichnung Description</b>
<b>LJ-003-020</b>	GRÜNWALD Zerstäuber, komplett mit 3 Zerstäuber, Ständer, ohne Halbgebläse <i>GRÜNWALD atomizer, complete with 2 atomizer, rack, without rubber bulb</i>
<b>LJ-003-021</b>	GRÜNWALD Zerstäuber, gerade Kanüle <i>GRÜNWALD atomizer, straight cannula</i>
<b>LJ-003-022</b>	GRÜNWALD Zerstäuber, abgebogene Kanüle <i>GRÜNWALD atomizer, tube downward</i>
<b>LJ-003-023</b>	GRÜNWALD Zerstäuber, aufgebogene Kanüle <i>GRÜNWALD atomizer, tube upward</i>
<b>LJ-003-024</b>	Halbgebläse für GRÜNWALD Zerstäuber <i>Rubber bulb for GRÜNWALD atomizer</i>
<b>LJ-003-025</b>	Ersatzglas (ohne Abbildung) <i>Spare bottle (without illustration)</i>



**LD-020-001**  
bis / to  
**LD-020-014**



**LD-020-015**  
bis / to  
**LD-020-018**

<b>Bestell-Nr. Ordering no.</b>	<b>Bezeichnung Description</b>
<b>LD-020-001</b>	BECKMANN Ringmesser, gerade, Fig. 1, 8mm BECKMANN adenoid curette, straight, fig. 1, 8mm
<b>LD-020-002</b>	BECKMANN Ringmesser, gerade, Fig. 2, 10mm BECKMANN adenoid curette, straight, fig. 2, 10mm
<b>LD-020-003</b>	BECKMANN Ringmesser, gerade, Fig. 3, 12mm BECKMANN adenoid curette, straight, fig. 3, 12mm
<b>LD-020-004</b>	BECKMANN Ringmesser, gerade, Fig. 4, 14mm BECKMANN adenoid curette, straight, fig. 4, 14mm
<b>LD-020-005</b>	BECKMANN Ringmesser, gerade, Fig. 5, 16mm BECKMANN adenoid curette, straight, fig. 5, 16mm
<b>LD-020-006</b>	BECKMANN Ringmesser, gerade, Fig. 6, 18mm BECKMANN adenoid curette, straight, fig. 6, 18mm
<b>LD-020-007</b>	BECKMANN Ringmesser, gerade, Fig. 7, 18mm BECKMANN adenoid curette, straight, fig. 7, 18mm
<b>LD-020-008</b>	BECKMANN Ringmesser, gebogen, Fig. 1, 8mm BECKMANN adenoid curette, curved, fig. 1, 8mm
<b>LD-020-009</b>	BECKMANN Ringmesser, gebogen, Fig. 2, 10mm BECKMANN adenoid curette, curved, fig. 2, 10mm
<b>LD-020-010</b>	BECKMANN Ringmesser, gebogen, Fig. 3, 12mm BECKMANN adenoid curette, curved, fig. 3, 12mm
<b>LD-020-011</b>	BECKMANN Ringmesser, gebogen, Fig. 4, 14mm BECKMANN adenoid curette, curved, fig. 4, 14mm
<b>LD-020-012</b>	BECKMANN Ringmesser, gebogen, Fig. 5, 16mm BECKMANN adenoid curette, curved, fig. 5, 16mm
<b>LD-020-013</b>	BECKMANN Ringmesser, gebogen, Fig. 6, 18mm BECKMANN adenoid curette, curved, fig. 6, 18mm
<b>LD-020-014</b>	BECKMANN Ringmesser, gebogen, Fig. 7, 18mm BECKMANN adenoid curette, curved, fig. 7, 18mm
<b>LD-020-015</b>	BARNHILL Ringmesser, gebogen, Fig. 1 BARNHILL adenoid curette, curved, fig. 1
<b>LD-020-016</b>	BARNHILL Ringmesser, gebogen, Fig. 2 BARNHILL adenoid curette, curved, fig. 2
<b>LD-020-017</b>	BARNHILL Ringmesser, gebogen, Fig. 3 BARNHILL adenoid curette, curved, fig. 3
<b>LD-020-018</b>	BARNHILL Ringmesser, gebogen, Fig. 4 BARNHILL adenoid curette, curved, fig. 4



**LD-020-020**  
bis / to  
**LD-020-023**



**LD-020-025**  
bis / to  
**LD-020-027**



**LD-200-001**  
bis / to  
**LD-200-004**

Bestell-Nr. Ordering no.	Bezeichnung Description
<b>LD-020-020</b>	LA FORCE Adenotom, Fig. 0, 10mm <i>LA FORCE adenotome, fig. 0, 10mm</i>
<b>LD-020-021</b>	LA FORCE Adenotom, Fig. 1, 13mm <i>LA FORCE adenotome, fig. 1, 13mm</i>
<b>LD-020-022</b>	LA FORCE Adenotom, Fig. 2, 16mm <i>LA FORCE adenotome, fig. 2, 16mm</i>
<b>LD-020-023</b>	LA FORCE Adenotom, Fig. 3, 19mm <i>LA FORCE adenotome, fig. 3, 19mm</i>
<b>LD-020-025</b>	SHAMBOUGH Adenotom, Fig. 1, 18mm <i>SHAMBOUGH adenotome, fig. 1, 18mm</i>
<b>LD-020-026</b>	SHAMBOUGH Adenotom, Fig. 2, 16mm <i>SHAMBOUGH adenotome, fig. 2, 16mm</i>
<b>LD-020-027</b>	SHAMBOUGH Adenotom, Fig. 3, 12mm <i>SHAMBOUGH adenotome, fig. 3, 12mm</i>
<b>LD-200-001</b>	ST. CLAIR-THOMPSON Kürette, Fig. 1 <i>ST. CLAIR-THOMPSON curette, Fig. 1</i>
<b>LD-200-002</b>	ST. CLAIR-THOMPSON Kürette, Fig. 2 <i>ST. CLAIR-THOMPSON curette, Fig. 2</i>
<b>LD-200-003</b>	ST. CLAIR-THOMPSON Kürette, Fig. 3 <i>ST. CLAIR-THOMPSON curette, Fig. 3</i>
<b>LD-200-004</b>	ST. CLAIR-THOMPSON Kürette, Fig. 4 <i>ST. CLAIR-THOMPSON curette, Fig. 4</i>



LD-100-052



LD-100-053



LD-100-054



LD-100-050



LD-100-051



LD-100-008 /  
LD-100-009

Bestell-Nr. Ordering no.	Bezeichnung Description
LD-100-008	LUNIATSCHECK, Tonsillen Tamponstopfer, 1.8mm breit, 19cm <i>LUNIATSCHECK, tonsil gauze packer, 1.8mm wide, 19cm</i>
LD-100-009	LUNIATSCHECK, Tonsillen Tamponstopfer, 2.5mm breit, 19cm <i>LUNIATSCHECK, tonsil gauze packer, 2.5mm wide, 19cm</i>
LD-100-050	HURD, Tonsillennadel, rechts <i>HURD, tonsil needle, right</i>
LD-100-051	HURD, Tonsillennadel, links <i>HURD, tonsil needle, left</i>
LD-100-052	TRELAT, Tonsillennadel, 23cm <i>TRELAT, tonsil needle, 23cm</i>
LD-100-053	CLAUS, Tonsillennadel, 23cm <i>CLAUS, tonsil needle, 23cm</i>
LD-100-054	NAGER, Tonsillennadel, 24cm <i>NAGER, tonsil needle, 24cm</i>

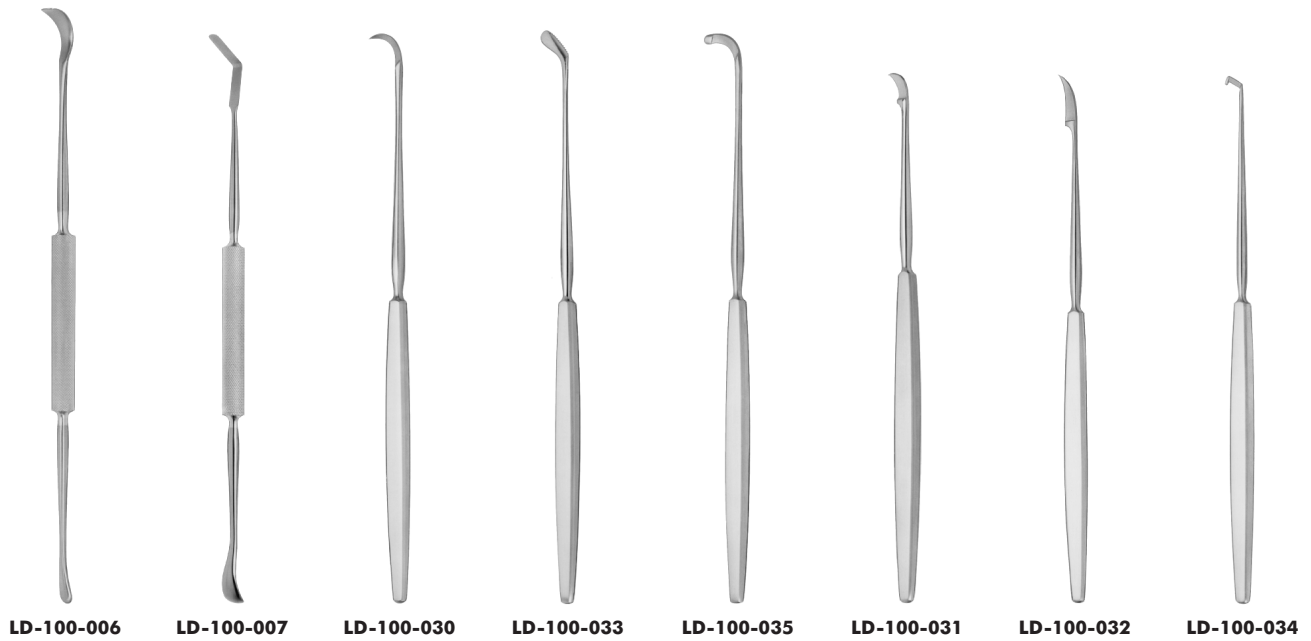

<b>Bestell-Nr.</b> <b>Ordering no.</b>	<b>Bezeichnung</b> <b>Description</b>
<b>LD-100-006</b>	CARPENTER, Tonsillennmesser und Dissektor, 24cm <i>CARPENTER, tonsil knife and dissector, 24cm</i>
<b>LD-100-007</b>	CARPENTER, Tonsillennmesser und Dissektor, 23cm <i>CARPENTER, tonsil knife and dissector, 23cm</i>
<b>LD-100-030</b>	BRÜNING, Tonsillennmesser, 23cm <i>BRÜNING, tonsil knife, 23cm</i>
<b>LD-100-031</b>	CANFIELD, Tonsillennmesser, 21cm <i>CANFIELD, tonsil knife, 21cm</i>
<b>LD-100-032</b>	ABRAHAM, Tonsillennmesser, spitz, 21cm <i>ABRAHAM, tonsil knife, pointed, 21cm</i>
<b>LD-100-033</b>	FISCHER, Tonsillennmesser, 22.5cm <i>FISCHER, tonsil knife, 22.5cm</i>
<b>LD-100-034</b>	DOUGLAS, Tonsillennmesser, 21cm <i>DOUGLAS, tonsil knife, 21cm</i>
<b>LD-100-035</b>	ABRAHAM, Tonsillennmesser, rund, 22.5cm <i>ABRAHAM, tonsil knife, round, 22.5cm</i>



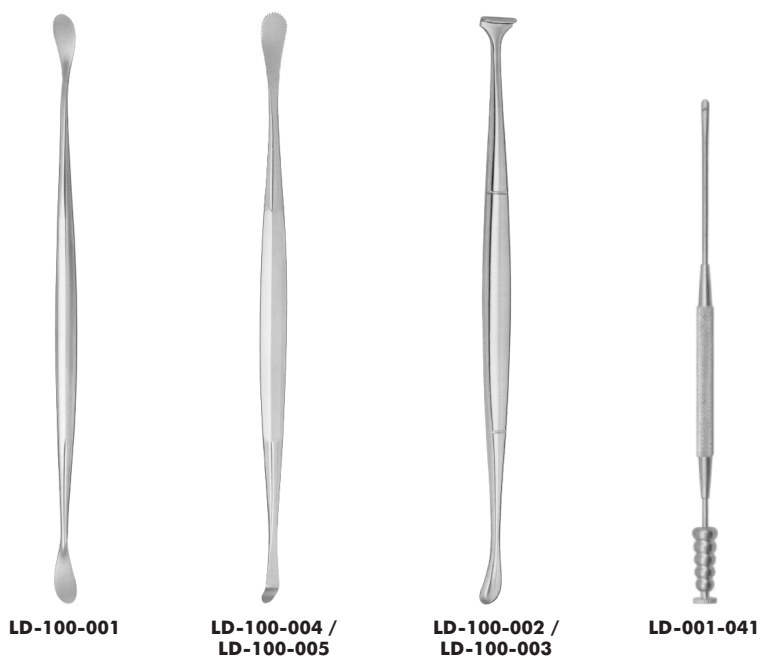

<b>Bestell-Nr. Ordering no.</b>	<b>Bezeichnung Description</b>
<b>LD-001-041</b>	FREER Saug elevator mit Mandrin, Länge 19cm <i>FREER suction elevator with mandrin, length 19cm</i>
<b>LD-100-001</b>	HENKE Tonsillenelevator, schmal, 23cm <i>HENKE tonsil elevator, small, 23cm</i>
<b>LD-100-002</b>	HURD, Tonsillendissektor, 22.5cm <i>HURD, tonsil dissector, 22.5cm</i>
<b>LD-100-003</b>	HURD, Tonsillendissektor, 10+12mm, 22.5cm <i>HURD, tonsil dissector, 10+12mm, 22.5cm</i>
<b>LD-100-004</b>	HENKE Tonsillenelevator, 12mm, 23cm <i>HENKE tonsil elevator, 12mm, 23cm</i>
<b>LD-100-005</b>	HENKE Tonsillenelevator, 17mm, 23cm <i>HENKE tonsil elevator, 17mm, 23cm</i>



LD-030-001



LD-030-031



LD-030-030



LD-030-002



LD-030-003  
bis / to  
LD-030-005

Bestell-Nr. Ordering no.	Bezeichnung Description
LD-030-001	REICHERT Kehlkopfdeckenhalter, 24cm <i>REICHERT epiglottis retractor, 24cm</i>
LD-030-002	ROBB LEWIS Gaumenhaken, 16cm <i>ROBB LEWIS tonsil hook, 16cm</i>
LD-030-003	LOVE Tonsillenretraktor, 18mm breit, 15cm <i>LOVE tonsil retractor, 18mm wide, 15cm</i>
LD-030-004	LOVE Tonsillenretraktor, 20mm breit, 15cm <i>LOVE tonsil retractor, 20mm wide, 15cm</i>
LD-030-005	LOVE Tonsillenretraktor, 22mm breit, 15cm <i>LOVE tonsil retractor, 22mm wide, 15cm</i>
LD-030-030	HASLINGER Gaumensegelhalter <i>HASLINGER elumid retractor</i>
LD-030-031	NAGER Gaumenhaken, 21cm <i>NAGER palate retractor, 21cm</i>

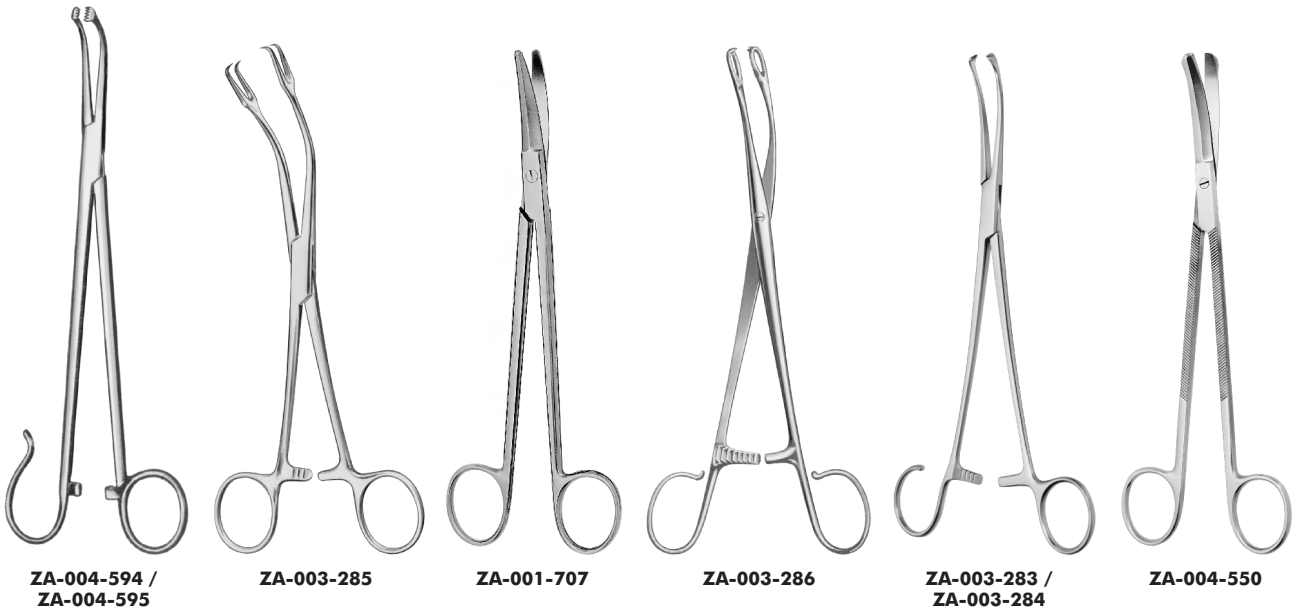

Bestell-Nr. Ordering no.	Bezeichnung Description
<b>ZA-001-707</b>	MUSEUX Tonsillenfasszange, 20cm <i>MUSEUX tonsil forceps, 20cm</i>
<b>ZA-003-283</b>	CLOVER Tonsillenfasszange, gerade, 19cm <i>CLOVER tonsil forceps, straight, 19cm</i>
<b>ZA-003-284</b>	CLOVER Tonsillenfasszange, gebogen, 19cm <i>CLOVER tonsil forceps, curved, 19cm</i>
<b>ZA-003-285</b>	MUSEUX Tonsillenfasszange, 20cm <i>MUSEUX tonsil forceps, 20cm</i>
<b>ZA-003-286</b>	BLOHMKE Tonsillenfasszange, 20cm <i>BLOHMKE tonsil forceps, 20cm</i>
<b>ZA-004-550</b>	GOOD Tonsillen- und Nasenschere, 19cm <i>GOOD tonsil and nasal scissors, 19cm</i>
<b>ZA-004-594</b>	WHITE Tonsillenzange, 18cm <i>WHITE tonsil forceps, 18cm</i>
<b>ZA-004-595</b>	WHITE Tonsillenzange, 23cm <i>WHITE tonsil forceps, 23cm</i>



**ZA-003-304**  
bis / to  
**ZA-003-315**



**ZA-003-290**



**ZA-003-291**  
bis / to  
**ZA-003-303**

<b>Bestell-Nr.</b> <b>Ordering no.</b>	<b>Bezeichnung</b> <b>Description</b>
<b>ZA-003-290</b>	Handgriff für Kehlkopfspiegel <i>Handle for laryngeal mirror</i>
<b>ZA-003-291</b>	Kehlkopfspiegel, 6mm, Fig. 000 <i>Laryngeal mirror, 6mm, fig. 000</i>
<b>ZA-003-292</b>	Kehlkopfspiegel, 8mm, Fig. 00 <i>Laryngeal mirror, 8mm, fig. 00</i>
<b>ZA-003-293</b>	Kehlkopfspiegel, 10mm, Fig. 0 <i>Laryngeal mirror, 10mm, fig. 0</i>
<b>ZA-003-294</b>	Kehlkopfspiegel, 12mm, Fig. 1 <i>Laryngeal mirror, 12mm, fig. 1</i>
<b>ZA-003-295</b>	Kehlkopfspiegel, 14mm, Fig. 2 <i>Laryngeal mirror, 14mm, fig. 2</i>
<b>ZA-003-296</b>	Kehlkopfspiegel, 16mm, Fig. 3 <i>Laryngeal mirror, 16mm, fig. 3</i>
<b>ZA-003-297</b>	Kehlkopfspiegel, 18mm, Fig. 4 <i>Laryngeal mirror, 18mm, fig. 4</i>
<b>ZA-003-298</b>	Kehlkopfspiegel, 20mm, Fig. 5 <i>Laryngeal mirror, 20mm, fig. 5</i>
<b>ZA-003-299</b>	Kehlkopfspiegel, 22mm, Fig. 6 <i>Laryngeal mirror, 22mm, fig. 6</i>
<b>ZA-003-300</b>	Kehlkopfspiegel, 24mm, Fig. 7 <i>Laryngeal mirror, 24mm, fig. 7</i>
<b>ZA-003-301</b>	Kehlkopfspiegel, 26mm, Fig. 8 <i>Laryngeal mirror, 26mm, fig. 8</i>
<b>ZA-003-302</b>	Kehlkopfspiegel, 28mm, Fig. 9 <i>Laryngeal mirror, 28mm, fig. 9</i>
<b>ZA-003-303</b>	Kehlkopfspiegel, 30mm, Fig. 10 <i>Laryngeal mirror, 30mm, fig. 10</i>
<b>ZA-003-304</b>	Kehlkopfspiegel mit Griff, 8mm, Fig. 00 <i>Laryngeal mirror with handle, 8mm, fig. 00</i>
<b>ZA-003-305</b>	Kehlkopfspiegel mit Griff, 10mm, Fig. 0 <i>Laryngeal mirror with handle, 10mm, fig. 0</i>
<b>ZA-003-306</b>	Kehlkopfspiegel mit Griff, 12mm, Fig. 1 <i>Laryngeal mirror with handle, 12mm, fig. 1</i>
<b>ZA-003-307</b>	Kehlkopfspiegel mit Griff, 14mm, Fig. 2 <i>Laryngeal mirror with handle, 14mm, fig. 2</i>
<b>ZA-003-308</b>	Kehlkopfspiegel mit Griff, 16mm, Fig. 3 <i>Laryngeal mirror with handle, 16mm, fig. 3</i>
<b>ZA-003-309</b>	Kehlkopfspiegel mit Griff, 18mm, Fig. 4 <i>Laryngeal mirror with handle, 18mm, fig. 4</i>
<b>ZA-003-310</b>	Kehlkopfspiegel mit Griff, 20mm, Fig. 5 <i>Laryngeal mirror with handle, 20mm, fig. 5</i>
<b>ZA-003-311</b>	Kehlkopfspiegel mit Griff, 22mm, Fig. 6 <i>Laryngeal mirror with handle, 22mm, fig. 6</i>
<b>ZA-003-312</b>	Kehlkopfspiegel mit Griff, 24mm, Fig. 7 <i>Laryngeal mirror with handle, 24mm, fig. 7</i>
<b>ZA-003-313</b>	Kehlkopfspiegel mit Griff, 26mm, Fig. 8 <i>Laryngeal mirror with handle, 26mm, fig. 8</i>
<b>ZA-003-314</b>	Kehlkopfspiegel mit Griff, 28mm, Fig. 9 <i>Laryngeal mirror with handle, 28mm, fig. 9</i>
<b>ZA-003-315</b>	Kehlkopfspiegel mit Griff, 30mm, Fig. 10 <i>Laryngeal mirror with handle, 30mm, fig. 10</i>



LD-020-030



LD-020-031/  
LD-020-032



LD-020-033



LD-020-034

Bestell-Nr. Ordering no.	Bezeichnung Description
LD-020-030	NEIVERT Tonsillenschnürer, 28cm <i>NEIVERT tonsil snare, 28cm</i>
LD-020-031	EVE Tonsillenschnürer ohne Raste, 28cm <i>EVE tonsil snare without ratchet, 28cm</i>
LD-020-032	EVE Tonsillenschnürer mit Raste, 28cm <i>EVE tonsil snare with ratchet, 28cm</i>
LD-020-033	LEWIS Tonsillenschnürer, 28cm <i>LEWIS tonsil snare, 28cm</i>
LD-020-034	BRÜNNING Tonsillenschnürer, 28cm <i>BRÜNNING tonsil snare, 28cm</i>



**LD-020-064**



**LD-020-060**



**LD-020-063**

<b>Bestell-Nr.</b> <b>Ordering no.</b>	<b>Bezeichnung</b> <b>Description</b>
<b>LD-020-060</b>	TYDING Tonsillenschnürer <i>TYDING tonsil snare</i>
<b>LD-020-061</b>	Aufsatz für TYDING Tonsillenschnürer (ohne Abbildung) <i>Tip for TYDING tonsil snare (without illustration)</i>
<b>LD-020-062</b>	VEDDER Aufsatz für TYDING Tonsillenschnürer (ohne Abbildung) <i>VEDDER tip for TYDING tonsil snare (without illustration)</i>
<b>LD-020-063</b>	SAGE Tonsillenschnürer mit automatischer Sperre <i>SAGE tonsil snare with automatic ratchet</i>
<b>LD-020-064</b>	RÖDER Tonsillenschnürer, 26.5cm <i>RÖDER tonsil snare, 26.5cm</i>



**LD-020-065**  
bis / to  
**LD-020-069**



**LD-020-070**  
bis / to  
**LD-020-072**

<b>Bestell-Nr. Ordering no.</b>	<b>Bezeichnung Description</b>
<b>LD-020-065</b>	SLUDER-BALLENGER Tonsillotom, komplett mit drei Aufsätzen <i>SLUDER-BALLENGER tonsillectome, complete incl. 3 blades</i>
<b>LD-020-066</b>	Aufsatz für SLUDER-BALLENGER Tonsillotom, Fig. 1 <i>Blade for SLUDER-BALLENGER tonsillectome, fig. 1</i>
<b>LD-020-067</b>	Aufsatz für SLUDER-BALLENGER Tonsillotom, Fig. 2 <i>Blade for SLUDER-BALLENGER tonsillectome, fig. 2</i>
<b>LD-020-068</b>	Aufsatz für SLUDER-BALLENGER Tonsillotom, Fig. 3 <i>Blade for SLUDER-BALLENGER tonsillectome, fig. 3</i>
<b>LD-020-069</b>	Griff für SLUDER-BALLENGER Tonsillotom <i>Handle for SLUDER-BALLENGER tonsillectome</i>
<b>LD-020-070</b>	DANIELS Tonsillotom mit Doppelklinge zum Quetschen und Schneiden, Fig. 1, 16mm <i>DANIELS tonsillectome with double blade for squeezing and cutting, fig. 1, 16mm</i>
<b>LD-020-071</b>	DANIELS Tonsillotom mit Doppelklinge zum Quetschen und Schneiden, Fig. 2, 20mm <i>DANIELS tonsillectome with double blade for squeezing and cutting, fig. 2, 20mm</i>
<b>LD-020-072</b>	DANIELS Tonsillotom mit Doppelklinge zum Quetschen und Schneiden, Fig. 3, 24mm <i>DANIELS tonsillectome with double blade for squeezing and cutting, fig. 3, 24mm</i>





**LD-020-035/  
LD-020-036**



**LD-020-037**  
bis / to  
**LD-020-041 /  
LD-020-047**  
bis / to  
**LD-020-051**



**LD-020-042**  
bis / to  
**LD-020-046 /  
LD-020-052**  
bis / to  
**LD-020-056**

<b>Bestell-Nr.</b> <b>Ordering no.</b>	<b>Bezeichnung</b> <b>Description</b>
<b>LD-020-035</b>	Drahtschlinge geschlossen, 0.4x50mm, 100 Stück <i>Wire loops, 0.4x50mm, 100 pieces</i>
<b>LD-020-036</b>	Drahtschlinge geschlossen, 0.4x40mm, 100 Stück <i>Wire loops, 0.4x40mm, 100 pieces</i>
<b>LD-020-037</b>	Schnürerdrähte für Tonsillenschnürer, 0.35mm, 11.5cm, 12 Stück <i>Snare wires for tonsil snare, 0.35mm, 11.5cm, 12 pieces</i>
<b>LD-020-038</b>	Schnürerdrähte für Tonsillenschnürer, 0.4mm, 11.5cm, 12 Stück <i>Snare wires for tonsil snare, 0.4mm, 11.5cm, 12 pieces</i>
<b>LD-020-039</b>	Schnürerdrähte für Tonsillenschnürer, 0.45mm, 11.5cm, 12 Stück <i>Snare wires for tonsil snare, 0.45mm, 11.5cm, 12 pieces</i>
<b>LD-020-040</b>	Schnürerdrähte für Tonsillenschnürer, 0.5mm, 11.5cm, 12 Stück <i>Snare wires for tonsil snare, 0.5mm, 11.5cm, 12 pieces</i>
<b>LD-020-041</b>	Schnürerdrähte für Tonsillenschnürer, 0.55mm, 11.5cm, 12 Stück <i>Snare wires for tonsil snare, 0.55mm, 11.5cm, 12 pieces</i>
<b>LD-020-042</b>	Schnürerdrähte für Tonsillenschnürer, 0.35mm, 11.5cm, 100 Stück <i>Snare wires for tonsil snare, 0.35mm, 11.5cm, 100 pieces</i>
<b>LD-020-043</b>	Schnürerdrähte für Tonsillenschnürer, 0.4mm, 11.5cm, 100 Stück <i>Snare wires for tonsil snare, 0.4mm, 11.5cm, 100 pieces</i>
<b>LD-020-044</b>	Schnürerdrähte für Tonsillenschnürer, 0.45mm, 11.5cm, 100 Stück <i>Snare wires for tonsil snare, 0.45mm, 11.5cm, 100 pieces</i>
<b>LD-020-045</b>	Schnürerdrähte für Tonsillenschnürer, 0.5mm, 11.5cm, 100 Stück <i>Snare wires for tonsil snare, 0.5mm, 11.5cm, 100 pieces</i>
<b>LD-020-046</b>	Schnürerdrähte für Tonsillenschnürer, 0.55mm, 11.5cm, 100 Stück <i>Snare wires for tonsil snare, 0.55mm, 11.5cm, 100 pieces</i>
<b>LD-020-047</b>	Schnürerdrähte für Tonsillenschnürer, 0.35mm, 10cm, 12 Stück <i>Snare wires for tonsil snare, 0.35mm, 10cm, 12 pieces</i>
<b>LD-020-048</b>	Schnürerdrähte für Tonsillenschnürer, 0.4mm, 10cm, 12 Stück <i>Snare wires for tonsil snare, 0.4mm, 10cm, 12 pieces</i>
<b>LD-020-049</b>	Schnürerdrähte für Tonsillenschnürer, 0.45mm, 10cm, 12 Stück <i>Snare wires for tonsil snare, 0.45mm, 10cm, 12 pieces</i>
<b>LD-020-050</b>	Schnürerdrähte für Tonsillenschnürer, 0.5mm, 10cm, 12 Stück <i>Snare wires for tonsil snare, 0.5mm, 10cm, 12 pieces</i>
<b>LD-020-051</b>	Schnürerdrähte für Tonsillenschnürer, 0.55mm, 10cm, 12 Stück <i>Snare wires for tonsil snare, 0.55mm, 10cm, 12 pieces</i>
<b>LD-020-052</b>	Schnürerdrähte für Tonsillenschnürer, 0.35mm, 10cm, 100 Stück <i>Snare wires for tonsil snare, 0.35mm, 10cm, 100 pieces</i>
<b>LD-020-053</b>	Schnürerdrähte für Tonsillenschnürer, 0.4mm, 10cm, 100 Stück <i>Snare wires for tonsil snare, 0.4mm, 10cm, 100 pieces</i>
<b>LD-020-054</b>	Schnürerdrähte für Tonsillenschnürer, 0.45mm, 10cm, 100 Stück <i>Snare wires for tonsil snare, 0.45mm, 10cm, 100 pieces</i>
<b>LD-020-055</b>	Schnürerdrähte für Tonsillenschnürer, 0.5mm, 10cm, 100 Stück <i>Snare wires for tonsil snare, 0.5mm, 10cm, 100 pieces</i>
<b>LD-020-056</b>	Schnürerdrähte für Tonsillenschnürer, 0.55mm, 10cm, 100 Stück <i>Snare wires for tonsil snare, 0.55mm, 10cm, 100 pieces</i>

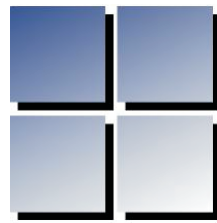

**STEMA**

Medizintechnik GmbH

**LARYNGOSKOPIE**

**LARYNGOSCOPY**







Bestell-Nr. Ordering no.	Bezeichnung Description	Merkmale	Features
<b>LA-011-001</b>	Tele-Laryngo-Pharyngoskop, Ø 10mm, Arbeitslänge 153mm, starr, Blickrichtung 90° <i>Tele-Laryngo-Pharyngoscope, Ø 10mm, working length 153mm, rigid, direction of view 90°</i>	<ul style="list-style-type: none"> <li>- Scharfes Bild</li> <li>- Außerordentliche Tiefenschärfe</li> <li>- Hochleistungs-Lichtsystem</li> <li>- 2 Vergrößerungsarten: Überblick und Detailbetrachtung</li> <li>- Luftkanal zur Vermeidung von beschlagenem Objektiv (LL)</li> <li>- Einlegbar und gassterilisierbar</li> </ul> <p>Arbeitsquerschnitt: 10.0mm Nutzlänge: 153mm Blickrichtung: 90° Arbeitsabstand: 15mm bis</p>	<ul style="list-style-type: none"> <li>- Sharp image</li> <li>- Significant depth of field</li> <li>- High performance illumination</li> <li>- 2 different degrees of magnification: panoramic view and examination of details</li> <li>- Air channel for prevention of misted objective (LL-connection)</li> <li>- soakable and designed for gas sterilization</li> </ul> <p>Working Ø: 10.0mm Working length: 153mm Direction of view: 90° Working distance: 15mm to</p>
<b>LA-011-004</b>	Wie LA-011-001 jedoch mit Blickrichtung <b>70°</b> und Nutzlänge <b>174.5mm</b> <i>As LA-011-001 but with direction of view 70° and working length 174.5mm</i>	Siehe LA-011-001	See LA-011-001
<b>LA-011-005</b>	Wie LA-011-001 jedoch mit Blickrichtung <b>70°</b> und Nutzlänge <b>147mm</b> <i>As LA-011-001 but with direction of view 70° and working length 147mm</i>	Siehe LA-011-001	See LA-011-001
<b>LA-011-002</b>	Tele-Laryngo-Pharyngoskop, Ø 6mm, Arbeitslänge 164mm, starr, Blickrichtung 70° <i>Tele-Laryngo-Pharyngoscope, Ø 6mm, working length 164mm, rigid, direction of view 70°</i>	<ul style="list-style-type: none"> <li>- Scharfes Bild</li> <li>- Außerordentliche Tiefenschärfe</li> <li>- Hochleistungs-Lichtsystem</li> <li>- Einlegbar und gassterilisierbar</li> </ul> <p>Arbeitsquerschnitt: 6.0mm Nutzlänge: 164mm Blickrichtung: 70° Arbeitsabstand: 15mm bis</p>	<ul style="list-style-type: none"> <li>- Sharp image</li> <li>- Significant depth of field</li> <li>- High performance illumination</li> <li>- soakable and designed for gas sterilization</li> </ul> <p>Working Ø: 6.0mm Working length: 164mm Direction of view: 70° Working distance: 15mm to</p>
<b>LA-011-003</b>	Wie LA-011-002 jedoch mit <b>Ø 8mm</b> <i>As LA-011-002 but with Ø 8mm</i>	Siehe LA-011-002	See LA-011-002
<b>LA-011-006</b>	Wie LA-011-002 jedoch mit <b>Ø 11mm</b> , Blickrichtung <b>90°</b> und NL <b>145mm</b> <i>As LA-011-002 but with Ø 11mm, direction of view 90° and WL 145mm</i>	Siehe LA-011-002	See LA-011-002
<b>LA-011-007</b>	Wie LA-011-002 jedoch mit <b>Ø 4mm</b> und Nutzlänge <b>176mm</b> <i>As LA-011-002 but with Ø 4mm and working length 176mm</i>	Siehe LA-011-002	See LA-011-002
<b>LA-011-008</b>	Wie LA-011-002 jedoch mit <b>Ø 5mm</b> und Nutzlänge <b>176mm</b> <i>As LA-011-002 but with Ø 5mm and working length 176mm</i>	Siehe LA-011-002	See LA-011-002





LA-015-002 /  
LA-015-004 /  
LA-015-005



LA-015-026



LA-015-001 /  
LA-015-003



LA-015-020 /  
LA-015-021



LA-015-009  
bis / to  
LA-015-014



LA-015-027

Bestell-Nr. Ordering no.	Bezeichnung Description
LA-015-001	MC INTOSH Laryngoskop, komplettes Set <i>MC INTOSH laryngoscope, complete set</i>
LA-015-002	MC INTOSH Laryngoskop, komplettes Set, ohne Trafoanschluss <i>MC INTOSH laryngoscope, complete set, without transformer connector</i>
LA-015-003	MC INTOSH Laryngoskop, komplettes Set <i>MC INTOSH laryngoscope, complete set</i>
LA-015-004	MC INTOSH Laryngoskop, komplettes Set, ohne Trafoanschluss <i>MC INTOSH laryngoscope, complete set, without transformer connector</i>
LA-015-005	MC INTOSH Laryngoskop, komplettes Set, ohne Trafoanschluss <i>MC INTOSH laryngoscope, complete set, without transformer connector</i>
LA-015-009	MC INTOSH Spatel für Laryngoskop, 75mm <i>MC INTOSH blade used for laryngoscope, 75mm</i>
LA-015-010	MC INTOSH Spatel für Laryngoskop, 90mm <i>MC INTOSH blade used for laryngoscope, 90mm</i>
LA-015-011	MC INTOSH Spatel für Laryngoskop, 110mm <i>MC INTOSH blade used for laryngoscope, 110mm</i>
LA-015-012	MC INTOSH Spatel für Laryngoskop, 130mm <i>MC INTOSH blade used for laryngoscope, 130mm</i>
LA-015-013	MC INTOSH Spatel für Laryngoskop, 150mm <i>MC INTOSH blade used for laryngoscope, 150mm</i>
LA-015-014	MC INTOSH Spatel für Laryngoskop, 175mm <i>MC INTOSH blade used for laryngoscope, 175mm</i>
LA-015-020	Griff mit Trafo-Anschluss für Laryngoskop nach MC INTOSH <i>Handle with transformer connection for laryngoscope by MC INTOSH</i>
LA-015-021	Griff ohne Trafo-Anschluss für Laryngoskop nach MC INTOSH <i>Handle without transformer connection for laryngoscope by MC INTOSH</i>
LA-015-022	Ersatzbirne für LA-015-009 (ohne Abbildung) <i>Spare bulb for LA-015-009 (without illustration)</i>
LA-015-023	Ersatzbirne für LA-015-010 bis LA-015-014 (ohne Abbildung) <i>Spare bulb for LA-015-010 to LA-015-014 (without illustration)</i>
LA-015-024	Trafo 220V (siehe Abbildung LA-015-001/LA-015-003) <i>Transformer 220V (see illustration LA-015-001/LA-015-003)</i>
LA-015-025	Trafo 110V (siehe Abbildung LA-015-001/LA-015-003) <i>Transformer 110V (see illustration LA-015-001/LA-015-003)</i>
LA-015-026	Transportkoffer, allein <i>Case, only</i>
LA-015-027	Halogenlampe <i>Halogen lamp</i>

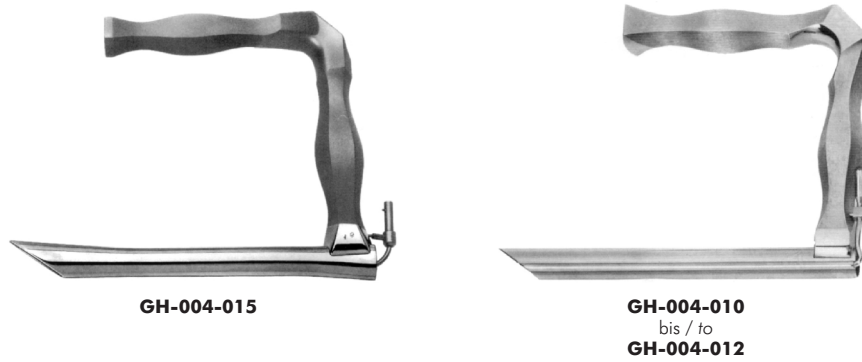

Bestell-Nr. Ordering no.	Bezeichnung Description
<b>GH-004-010</b>	JACKSON Laryngoskop, 120mm, für Kinder, mit Fiberglas-Lichträger <i>JACKSON laryngoscope, 120mm, for children, with fibreglas light guide</i>
<b>GH-004-011</b>	JACKSON Laryngoskop, 170mm, für Kinder, mit Fiberglas-Lichträger <i>JACKSON laryngoscope, 170mm, for children, with fibreglas light guide</i>
<b>GH-004-012</b>	JACKSON Laryngoskop, 180mm, für Erwachsene, mit Fiberglas-Lichträger <i>JACKSON laryngoscope, 180mm, for adult, with fibreglas light guide</i>
<b>GH-004-015</b>	HOLINGER Laryngoskop, 180mm, für Erwachsene, mit Fiberglas-Lichträger <i>HOLINGER laryngoscope, 180mm, for adult, with fibreglas light guide</i>
<b>GH-005-001</b>	Stahlgriff ohne Trafoanschluss, Ø 30mm, Batteriebetrieb <i>Handle without transformer connection, Ø 30mm, stainless steel, battery</i>
<b>GH-005-002</b>	Stahlgriff ohne Trafoanschluss, Ø 30mm, Batteriebetrieb <i>Handle without transformer connection, Ø 30mm, stainless steel, battery</i>
<b>GH-005-003</b>	Stahlgriff ohne Trafoanschluss, Ø 18mm, Batteriebetrieb <i>Handle without transformer connection, Ø 18mm, stainless steel, battery</i>
<b>GH-005-004</b>	Messinggriff glänzend, ohne Trafoanschluss, Ø 38mm, Batteriebetrieb <i>Handle without transformer connection, Ø 38mm, chromium plate, polished, battery</i>
<b>GH-005-005</b>	Messinggriff matt, ohne Trafoanschluss, Ø 30mm, Batteriebetrieb <i>Handle without transformer connection, Ø 30mm, chromium plate, matt, battery</i>
<b>GH-005-006</b>	Messinggriff matt, ohne Trafoanschluss, Ø 30mm, Batteriebetrieb <i>Handle without transformer connection, Ø 30mm, chromium plate, matt, battery</i>
<b>GH-005-007</b>	Stahlgriff ohne Trafoanschluss, Ø 30mm, Batteriebetrieb <i>Handle without transformer connection, Ø 30mm, stainless steel, battery</i>
<b>GH-005-008</b>	Stahlgriff ohne Trafoanschluss, Ø 30mm, Batteriebetrieb <i>Handle without transformer connection, Ø 30mm, stainless steel, battery</i>
<b>GH-005-009</b>	Halogenlampe <i>Halogen lamp</i>



**GH-004-020**  
bis / to  
**GH-004-023**



**GH-004-025**  
bis / to  
**GH-004-029**



**GH-004-035**  
bis / to  
**GH-004-038**



**GH-004-030**  
bis / to  
**GH-004-034**

<b>Bestell-Nr.</b> <b>Ordering no.</b>	<b>Bezeichnung</b> <b>Description</b>
<b>GH-004-020</b>	MC INTOSH Spatel für Laryngoskop, 88mm, amerikanisches Modell <i>MC INTOSH blade used for laryngoscope, 88mm, american model</i>
<b>GH-004-021</b>	MC INTOSH Spatel für Laryngoskop, 111mm, amerikanisches Modell <i>MC INTOSH blade used for laryngoscope, 111mm, american model</i>
<b>GH-004-022</b>	MC INTOSH Spatel für Laryngoskop, 132mm, amerikanisches Modell <i>MC INTOSH blade used for laryngoscope, 132mm, american model</i>
<b>GH-004-023</b>	MC INTOSH Spatel für Laryngoskop, 160mm, amerikanisches Modell <i>MC INTOSH blade used for laryngoscope, 160mm, american model</i>
<b>GH-004-025</b>	MILLER Spatel für Laryngoskop, 75mm <i>MILLER blade used for laryngoscope, 75mm</i>
<b>GH-004-026</b>	MILLER Spatel für Laryngoskop, 100mm <i>MILLER blade used for laryngoscope, 100mm</i>
<b>GH-004-027</b>	MILLER Spatel für Laryngoskop, 155mm <i>MILLER blade used for laryngoscope, 155mm</i>
<b>GH-004-028</b>	MILLER Spatel für Laryngoskop, 195mm <i>MILLER blade used for laryngoscope, 195mm</i>
<b>GH-004-029</b>	MILLER Spatel für Laryngoskop, 205mm <i>MILLER blade used for laryngoscope, 205mm</i>
<b>GH-004-030</b>	WISCONSIN-FOREGGER Spatel für Laryngoskop, 92mm <i>WISCONSIN-FOREGGER blade used for laryngoscope, 92mm</i>
<b>GH-004-031</b>	WISCONSIN-FOREGGER Spatel für Laryngoskop, 115mm <i>WISCONSIN-FOREGGER blade used for laryngoscope, 115mm</i>
<b>GH-004-032</b>	WISCONSIN-FOREGGER Spatel für Laryngoskop, 130mm <i>WISCONSIN-FOREGGER blade used for laryngoscope, 130mm</i>
<b>GH-004-033</b>	WISCONSIN-FOREGGER Spatel für Laryngoskop, 160mm <i>WISCONSIN-FOREGGER blade used for laryngoscope, 160mm</i>
<b>GH-004-034</b>	WISCONSIN-FOREGGER Spatel für Laryngoskop, 190mm <i>WISCONSIN-FOREGGER blade used for laryngoscope, 190mm</i>
<b>GH-004-035</b>	NEGUS-GUEDEL Spatel für Laryngoskop, 90mm <i>NEGUS-GUEDEL blade used for laryngoscope, 90mm</i>
<b>GH-004-036</b>	NEGUS-GUEDEL Spatel für Laryngoskop, 110mm <i>NEGUS-GUEDEL blade used for laryngoscope, 110mm</i>
<b>GH-004-037</b>	NEGUS-GUEDEL Spatel für Laryngoskop, 130mm <i>NEGUS-GUEDEL blade used for laryngoscope, 130mm</i>
<b>GH-004-038</b>	NEGUS-GUEDEL Spatel für Laryngoskop, 160mm <i>NEGUS-GUEDEL blade used for laryngoscope, 160mm</i>





**GH-004-060**  
bis / to  
**GH-004-064**



**GH-004-065**  
bis / to  
**GH-004-070**



**GH-004-071**  
bis / to  
**GH-004-075**



**GH-004-076**  
bis / to  
**GH-004-080**

Bestell-Nr. Ordering no.	Bezeichnung Description
<b>GH-004-060</b>	MC INTOSH Fiber-Optik Spatel für Laryngoskop, integrierter Lichtleiter, 75mm <i>MC INTOSH fiberoptic blade used for laryngoscope, internal light conductor, 75mm</i>
<b>GH-004-061</b>	MC INTOSH Fiber-Optik Spatel für Laryngoskop, integrierter Lichtleiter, 90mm <i>MC INTOSH fiberoptic blade used for laryngoscope, internal light conductor, 90mm</i>
<b>GH-004-062</b>	MC INTOSH Fiber-Optik Spatel für Laryngoskop, integrierter Lichtleiter, 110mm <i>MC INTOSH fiberoptic blade used for laryngoscope, internal light conductor, 110mm</i>
<b>GH-004-063</b>	MC INTOSH Fiber-Optik Spatel für Laryngoskop, integrierter Lichtleiter, 130mm <i>MC INTOSH fiberoptic blade used for laryngoscope, internal light conductor, 130mm</i>
<b>GH-004-064</b>	MC INTOSH Fiber-Optik Spatel für Laryngoskop, integrierter Lichtleiter, 150mm <i>MC INTOSH fiberoptic blade used for laryngoscope, internal light conductor, 150mm</i>
<b>GH-004-065</b>	MC INTOSH Fiber-Optik Spatel für Laryngoskop, seitliche Röhrchen, 75mm <i>MC INTOSH fiberoptic blade used for laryngoscope, lateral small tubes, 75mm</i>
<b>GH-004-066</b>	MC INTOSH Fiber-Optik Spatel für Laryngoskop, seitliche Röhrchen, 90mm <i>MC INTOSH fiberoptic blade used for laryngoscope, lateral small tubes, 90mm</i>
<b>GH-004-067</b>	MC INTOSH Fiber-Optik Spatel für Laryngoskop, seitliche Röhrchen, 110mm <i>MC INTOSH fiberoptic blade used for laryngoscope, lateral small tubes, 110mm</i>
<b>GH-004-068</b>	MC INTOSH Fiber-Optik Spatel für Laryngoskop, seitliche Röhrchen, 130mm <i>MC INTOSH fiberoptic blade used for laryngoscope, lateral small tubes, 130mm</i>
<b>GH-004-069</b>	MC INTOSH Fiber-Optik Spatel für Laryngoskop, seitliche Röhrchen, 150mm <i>MC INTOSH fiberoptic blade used for laryngoscope, lateral small tubes, 150mm</i>
<b>GH-004-070</b>	MC INTOSH Fiber-Optik Spatel für Laryngoskop, seitliche Röhrchen, 170mm <i>MC INTOSH fiberoptic blade used for laryngoscope, lateral small tubes, 170mm</i>
<b>GH-004-071</b>	MC INTOSH Fiber-Optik Spatel für Laryngoskop, seitliche Röhrchen, 88mm, amerikanisches Modell <i>MC INTOSH fiberoptic blade used for laryngoscope, lateral small tubes, 88mm, american model</i>
<b>GH-004-072</b>	MC INTOSH Fiber-Optik Spatel für Laryngoskop, seitliche Röhrchen, 111mm, amerikanisches Modell <i>MC INTOSH fiberoptic blade used for laryngoscope, lateral small tubes, 111mm, american model</i>
<b>GH-004-073</b>	MC INTOSH Fiber-Optik Spatel für Laryngoskop, seitliche Röhrchen, 132mm, amerikanisches Modell <i>MC INTOSH fiberoptic blade used for laryngoscope, lateral small tubes, 132mm, american model</i>
<b>GH-004-074</b>	MC INTOSH Fiber-Optik Spatel für Laryngoskop, seitliche Röhrchen, 144mm, amerikanisches Modell <i>MC INTOSH fiberoptic blade used for laryngoscope, lateral small tubes, 144mm, american model</i>
<b>GH-004-075</b>	MC INTOSH Fiber-Optik Spatel für Laryngoskop, seitliche Röhrchen, 160mm, amerikanisches Modell <i>MC INTOSH fiberoptic blade used for laryngoscope, lateral small tubes, 160mm, american model</i>
<b>GH-004-076</b>	MILLER Fiber-Optik Spatel für Laryngoskop, 75mm <i>MILLER fiberoptic blade used for laryngoscope, 75mm</i>
<b>GH-004-077</b>	MILLER Fiber-Optik Spatel für Laryngoskop, 100mm <i>MILLER fiberoptic blade used for laryngoscope, 100mm</i>
<b>GH-004-078</b>	MILLER Fiber-Optik Spatel für Laryngoskop, 155mm <i>MILLER fiberoptic blade used for laryngoscope, 155mm</i>
<b>GH-004-079</b>	MILLER Fiber-Optik Spatel für Laryngoskop, 195mm <i>MILLER fiberoptic blade used for laryngoscope, 195mm</i>
<b>GH-004-080</b>	MILLER Fiber-Optik Spatel für Laryngoskop, 205mm <i>MILLER fiberoptic blade used for laryngoscope, 205mm</i>



<b>Bestell-Nr.</b> <b>Ordering no.</b>	<b>Bezeichnung</b> <b>Description</b>
<b>GH-004-001</b>	Operationslaryngoskop, Fig. 1, AL 135mm Operating laryngoscope, fig. 1, WL 135mm
<b>GH-004-002</b>	Operationslaryngoskop, Fig. 2, AL 152mm Operating laryngoscope, fig. 2, WL 152mm
<b>GH-004-003</b>	Operationslaryngoskop, Fig. 3, AL 182mm Operating laryngoscope, fig. 3, WL 182mm
<b>GH-004-004</b>	Operationslaryngoskop, Fig. 4, AL 172mm Operating laryngoscope, fig. 4, WL 172mm
<b>GH-004-005</b>	Operationslaryngoskop, Fig. 5, AL 172mm Operating laryngoscope, fig. 5, WL 172mm
<b>GH-004-006</b>	Operationslaryngoskop, Fig. 6, AL 182mm Operating laryngoscope, fig. 6, WL 182mm
<b>GH-004-007</b>	Operationslaryngoskop, Fig. 7, AL 222mm Operating laryngoscope, fig. 7, WL 222mm
<b>GH-004-050</b>	Fiberglas-Lichtleiter für GH-004-001 bis GH-004-002 Fiberglas light guide used for GH-004-001 to GH-004-002
<b>GH-004-051</b>	Fiberglas-Lichtleiter für GH-004-003 bis GH-004-006 Fiberglas light guide used for GH-004-003 to GH-004-006
<b>GH-004-052</b>	Fiberglas-Lichtleiter für GH-004-007 Fiberglas light guide used for GH-004-007
<b>GH-004-053</b>	Injektionskanüle für GH-004-001 bis GH-004-007 Injections drain tube used for GH-004-001 to GH-004-007
<b>GH-004-054</b>	Rauchabsaugrohr für GH-004-003 bis GH-004-007 Suction tube used for GH-004-004 to GH-004-007
<b>GH-004-081</b>	Operationslaryngoskop gebogen, Fig. 7, innenliegendes Rauchabsaugrohr Operating laryngoscope curved, fig. 7, smoke suction tube inside
<b>GH-004-082</b>	Operationslaryngoskop spreizbar, Fig. 1 Operating laryngoscope spreadable, fig. 1
<b>GH-004-083</b>	Operationslaryngoskop spreizbar, Fig. 2 Operating laryngoscope spreadable, fig. 2
<b>GH-004-084</b>	Operationslaryngoskop spreizbar, Fig. 3 Operating laryngoscope spreadable, fig. 3
<b>GH-004-085</b>	Operationslaryngoskop spreizbar, Fig. 4 Operating laryngoscope spreadable, fig. 4
<b>GH-004-086</b>	Operationslaryngoskop spreizbar, Fig. 5 Operating laryngoscope spreadable, fig. 5
<b>GH-004-087</b>	Operationslaryngoskop spreizbar, Fig. 6 Operating laryngoscope spreadable, fig. 6
<b>GH-004-088</b>	Operationslaryngoskop spreizbar, Fig. 7 Operating laryngoscope spreadable, fig. 7



**LD-200-204**  
bis / to  
**LD-200-206**



**LD-200-200 /**  
**LD-200-201**

<b>Bestell-Nr.</b> <b>Ordering no.</b>	<b>Bezeichnung</b> <b>Description</b>
<b>LD-200-200</b>	Bruststütze mit Stützstange für Erwachsene, Ringgröße, Ø 9.5mm, Stützstange 34cm <i>Laryngoscope holder and chest support for adults, ring Ø 9.5mm, rod length 34cm</i>
<b>LD-200-201</b>	Stützstange für Kinder, Ring Ø 9.5mm, Stützstange 24cm <i>Rod for children, ring Ø 9.5mm, rod length 24cm</i>
<b>LD-200-204</b>	NEGUS Bruststütze, 14cm, komplett <i>NEGUS chest support, 14cm, complete</i>
<b>LD-200-205</b>	NEGUS Bruststütze, 11cm, komplett <i>NEGUS chest support, 11cm, complete</i>
<b>LD-200-206</b>	NEGUS Bruststütze, 8.5cm, komplett <i>NEGUS chest support, 8.5cm, complete</i>

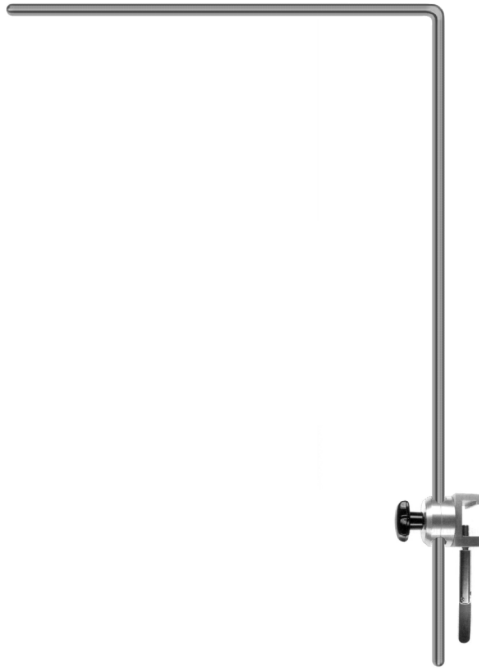

**LD-200-202**

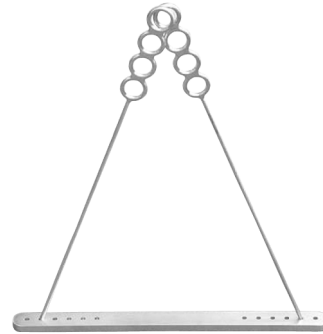

**LD-200-207**

<b>Bestell-Nr.</b> <b>Ordering no.</b>	<b>Bezeichnung</b> <b>Description</b>
<b>LD-200-202</b>	Narkosebügel mit Spannkloben zur Befestigung an OP-Tisch <i>Anaesthesia frame with clamp for mounting on operating table</i>
<b>LD-200-203</b>	Kette zur Aufhängung der Mundsperrer an Narkosebügel (ohne Abbildung) <i>Chain with ring to suspend the mouth gag at the frame (without illustration)</i>
<b>LD-200-207</b>	DRAFFIN Mundsperrer-Aufhängung <i>DRAFFIN suspension apparatus for mouth gags</i>



LD-005-021

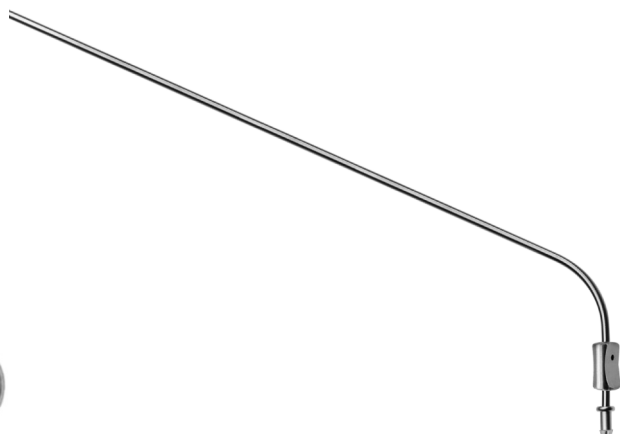

GH-010-001  
bis / to  
GH-010-003



LJ-002-035  
bis / to  
LJ-002-039



LJ-002-040  
bis / to  
LJ-002-044

Bestell-Nr. Ordering no.	Bezeichnung Description
GH-010-001	KLEINSASSER Saugrohr, Ø 2.0mm, AL 23cm KLEINSASSER suction tube, Ø 2.0mm, WL 23cm
GH-010-002	KLEINSASSER Saugrohr, Ø 2.5mm, AL 23cm KLEINSASSER suction tube, Ø 2.5mm, WL 23cm
GH-010-003	KLEINSASSER Saugrohr, Ø 3.0mm, AL 23cm KLEINSASSER suction tube, Ø 3.0mm, WL 23cm
LD-005-021	PELTESON Kehlkopfwatteträger, 23.5cm PELTESON laryngeal applicator, 23.5cm
LJ-002-035	RECORD Spritze "PERFECT" mit drehbaren Ringen, 2ml RECORD syringe " PERFECT" with rings, 2ml
LJ-002-036	RECORD Spritze "PERFECT" mit drehbaren Ringen, 5ml RECORD syringe " PERFECT" with rings, 5ml
LJ-002-037	RECORD Spritze "PERFECT" mit drehbaren Ringen, 10ml RECORD syringe " PERFECT" with rings, 10ml
LJ-002-038	RECORD Spritze "PERFECT" mit drehbaren Ringen, 20ml RECORD syringe " PERFECT" with rings, 20ml
LJ-002-039	RECORD Spritze "PERFECT" mit drehbaren Ringen, 30ml RECORD syringe " PERFECT" with rings, 30ml
LJ-002-040	Ersatzzylinder, RECORD Spritze "PERFECT" , 2ml Spare barrel, RECORD syringe " PERFECT", 2ml
LJ-002-041	Ersatzzylinder, RECORD Spritze "PERFECT" , 5ml Spare barrel, RECORD syringe " PERFECT", 5ml
LJ-002-042	Ersatzzylinder, RECORD Spritze "PERFECT" , 10ml Spare barrel, RECORD syringe " PERFECT", 10ml
LJ-002-043	Ersatzzylinder, RECORD Spritze "PERFECT" , 20ml Spare barrel, RECORD syringe " PERFECT", 20ml
LJ-002-044	Ersatzzylinder, RECORD Spritze "PERFECT" , 30ml Spare barrel, RECORD syringe " PERFECT", 30ml

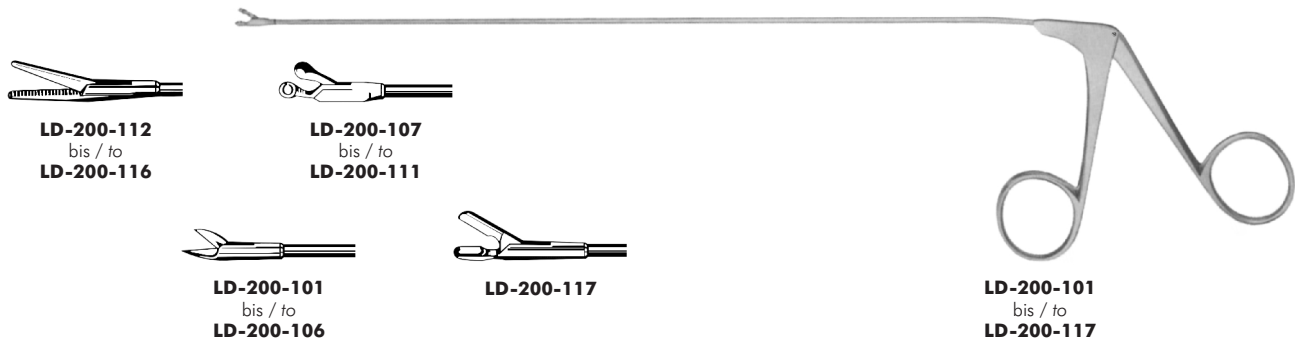

Bestell-Nr. Ordering no.	Bezeichnung Description
LD-200-101	KLEINSASSER Schere, gerade, Ø 2.0mm, AL 25cm KLEINSASSER scissors, straight, Ø 2.0mm, WL 25cm
LD-200-102	KLEINSASSER Schere, gerade, horizontal, Ø 2.0mm, AL 25cm KLEINSASSER scissors, straight, horizontal, Ø 2.0mm, WL 25cm
LD-200-103	KLEINSASSER Schere, aufgebogen, Ø 2.0mm, AL 25cm KLEINSASSER scissors, upcurved, Ø 2.0mm, WL 25cm
LD-200-104	KLEINSASSER Schere, horizontal aufgebogen, Ø 2.0mm, AL 25cm KLEINSASSER scissors, horizontal upcurved, Ø 2.0mm, WL 25cm
LD-200-105	KLEINSASSER Schere, rechts gebogen, Ø 2.0mm, AL 25cm KLEINSASSER scissors, curved right, Ø 2.0mm, WL 25cm
LD-200-106	KLEINSASSER Schere, links gebogen, Ø 2.0mm, AL 25cm KLEINSASSER scissors, curved left, Ø 2.0mm, WL 25cm
LD-200-107	KLEINSASSER Löffelzange, gerade, Ø 2.5mm, AL 25cm KLEINSASSER spoon forceps, straight, Ø 2.5mm, WL 25cm
LD-200-108	KLEINSASSER Löffelzange, aufgebogen, Ø 2.5mm, AL 25cm KLEINSASSER spoon forceps, upcurved, Ø 2.5mm, WL 25cm
LD-200-109	KLEINSASSER Löffelzange, horizontal aufgebogen, Ø 2.5mm, AL 25cm KLEINSASSER spoon forceps, horizontal upcurved, Ø 2.5mm, WL 25cm
LD-200-110	KLEINSASSER Löffelzange, rechts gebogen, Ø 2.5mm, AL 25cm KLEINSASSER spoon forceps, curved right, Ø 2.5mm, WL 25cm
LD-200-111	KLEINSASSER Löffelzange, links gebogen, Ø 2.5mm, AL 25cm KLEINSASSER spoon forceps, curved left, Ø 2.5mm, WL 25cm
LD-200-112	KLEINSASSER Alligator Fasszange, gerade, Ø 2.0mm, AL 25cm KLEINSASSER alligator forceps, straight, Ø 2.0mm, WL 25cm
LD-200-113	KLEINSASSER Alligator Fasszange, gerade horizontal, Ø 2.0mm, AL 25cm KLEINSASSER alligator forceps, straight horizontal, Ø 2.0mm, WL 25cm
LD-200-114	KLEINSASSER Alligator Fasszange, horizontal aufgebogen, Ø 2.0mm, AL 25cm KLEINSASSER alligator forceps, horizontal upcurved, Ø 2.0mm, WL 25cm
LD-200-115	KLEINSASSER Alligator Fasszange, rechts gebogen, Ø 2.0mm, AL 25cm KLEINSASSER alligator forceps, curved right, Ø 2.0mm, WL 25cm
LD-200-116	KLEINSASSER Alligator Fasszange, links gebogen, Ø 2.0mm, AL 25cm KLEINSASSER alligator forceps, curved left, Ø 2.0mm, WL 25cm
LD-200-117	KLEINSASSER Löffelzange oval, gerade, Ø 2.5mm, AL 25cm KLEINSASSER spoon forceps oval, straight, Ø 2.5mm, WL 25cm



**LD-200-120**  
bis / to  
**LD-200-126**



**LD-200-127**  
bis / to  
**LD-200-132**



**LD-200-133**  
bis / to  
**LD-200-137**



**LD-200-138**  
bis / to  
**LD-200-154**

Bestell-Nr. Ordering no.	Bezeichnung Description
<b>LD-200-120</b>	KLEINSASSER Schere, gerade, Ø 3.0 - 2.0mm, AL 23cm KLEINSASSER scissors, straight, Ø 3.0 - 2.0mm, WL 23cm
<b>LD-200-121</b>	KLEINSASSER Schere, gerade horizontal, Ø 3.0 - 2.0mm, AL 23cm KLEINSASSER scissors, straight horizontal, Ø 3.0 - 2.0mm, WL 23cm
<b>LD-200-122</b>	KLEINSASSER Schere, aufgebogen, Ø 3.0 - 2.0mm, AL 23cm KLEINSASSER scissors, upcurved, Ø 3.0 - 2.0mm, WL 23cm
<b>LD-200-123</b>	KLEINSASSER Schere, horizontal aufgebogen, Ø 3.0 - 2.0mm, AL 23cm KLEINSASSER scissors, horizontal upcurved, Ø 3.0 - 2.0mm, WL 23cm
<b>LD-200-124</b>	KLEINSASSER Schere, rechts gebogen, Ø 3.0 - 2.0mm, AL 23cm KLEINSASSER scissors, curved right, Ø 3.0 - 2.0mm, WL 23cm
<b>LD-200-125</b>	KLEINSASSER Schere, links gebogen, Ø 3.0 - 2.0mm, AL 23cm KLEINSASSER scissors, curved left, Ø 3.0 - 2.0mm, WL 23cm
<b>LD-200-126</b>	KLEINSASSER Schere, 15° aufgebogen, Ø 3.0 - 2.0mm, AL 23cm KLEINSASSER scissors, 15° upcurved, Ø 3.0 - 2.0mm, WL 23cm
<b>LD-200-127</b>	KLEINSASSER Alligator Faszange, gerade, Ø 3.0 - 2.0mm, AL 23cm KLEINSASSER alligator forceps, straight, Ø 3.0 - 2.0mm, WL 23cm
<b>LD-200-128</b>	KLEINSASSER Alligator Faszange, gerade horizontal, Ø 3.0 - 2.0mm, AL 23cm KLEINSASSER alligator forceps, straight horizontal, Ø 3.0 - 2.0mm, WL 23cm
<b>LD-200-129</b>	KLEINSASSER Alligator Faszange, horizontal aufgebogen, Ø 3.0 - 2.0mm, AL 23cm KLEINSASSER alligator forceps, horizontal upcurved, Ø 3.0 - 2.0mm, WL 23cm
<b>LD-200-130</b>	KLEINSASSER Alligator Faszange, rechts gebogen, Ø 3.0 - 2.0mm, AL 23cm KLEINSASSER alligator forceps, curved right, Ø 3.0 - 2.0mm, WL 23cm
<b>LD-200-131</b>	KLEINSASSER Alligator Faszange, links gebogen, Ø 3.0 - 2.0mm, AL 23cm KLEINSASSER alligator forceps, curved left, Ø 3.0 - 2.0mm, WL 23cm
<b>LD-200-132</b>	KLEINSASSER Alligator Faszange, aufgebogen, Ø 3.0 - 2.0mm, AL 23cm KLEINSASSER alligator forceps, upcurved, Ø 3.0 - 2.0mm, WL 23cm
<b>LD-200-133</b>	KLEINSASSER Löffelzange, gerade, Ø 3.0 - 2.0mm, AL 23cm KLEINSASSER spoon forceps, straight, Ø 3.0 - 2.0mm, WL 23cm
<b>LD-200-134</b>	KLEINSASSER Löffelzange, aufgebogen, Ø 3.0 - 2.0mm, AL 23cm KLEINSASSER spoon forceps, upcurved, Ø 3.0 - 2.0mm, WL 23cm
<b>LD-200-135</b>	KLEINSASSER Löffelzange, horizontal aufgebogen, Ø 3.0 - 2.0mm, AL 23cm KLEINSASSER spoon forceps, horizontal upcurved, Ø 3.0 - 2.0mm, WL 23cm
<b>LD-200-136</b>	KLEINSASSER Löffelzange, rechts gebogen, Ø 3.0 - 2.0mm, AL 23cm KLEINSASSER spoon forceps, curved right, Ø 3.0 - 2.0mm, WL 23cm
<b>LD-200-137</b>	KLEINSASSER Löffelzange, links gebogen, Ø 3.0 - 2.0mm, AL 23cm KLEINSASSER spoon forceps, curved left, Ø 3.0 - 2.0mm, WL 23cm





**LD-200-138 /  
LD-200-139**



**LD-200-140  
bis / to  
LD-200-146**



**LD-200-147  
bis / to  
LD-200-154**



**LD-200-138  
bis / to  
LD-200-154**

Bestell-Nr. Ordering no.	Bezeichnung Description
<b>LD-200-138</b>	KLEINSASSER Löffelzange aufgebogen, 45° rechts, Ø 3.0 - 2.0mm, AL 23cm <i>KLEINSASSER spoon forceps, up curved, 45° right, Ø 3.0 - 2.0mm, WL 23cm</i>
<b>LD-200-139</b>	KLEINSASSER Löffelzange aufgebogen, 45° links, Ø 3.0 - 2.0mm, AL 23cm <i>KLEINSASSER spoon forceps, up curved, 45° left, Ø 3.0 - 2.0mm, WL 23cm</i>
<b>LD-200-140</b>	KLEINSASSER Löffelzange oval, gerade, Ø 3.0 - 2.0mm, AL 23cm <i>KLEINSASSER spoon forceps oval, straight, Ø 3.0 - 2.0mm, WL 23cm</i>
<b>LD-200-141</b>	KLEINSASSER Löffelzange oval, 45° aufgebogen, Ø 3.0 - 2.0mm, AL 23cm <i>KLEINSASSER spoon forceps oval, 45° upcurved, Ø 3.0 - 2.0mm, WL 23cm</i>
<b>LD-200-142</b>	KLEINSASSER Löffelzange oval, rechts gebogen, Ø 3.0 - 2.0mm, AL 23cm <i>KLEINSASSER spoon forceps oval, curved right, Ø 3.0 - 2.0mm, WL 23cm</i>
<b>LD-200-143</b>	KLEINSASSER Löffelzange oval, links gebogen, Ø 3.0 - 2.0mm, AL 23cm <i>KLEINSASSER spoon forceps oval, curved left, Ø 3.0 - 2.0mm, WL 23cm</i>
<b>LD-200-144</b>	KLEINSASSER Löffelzange oval, spitz, 45° aufgebogen, Ø 3.0 - 2.0mm, AL 23cm <i>KLEINSASSER spoon forceps oval, pointed, 45° upcurved, Ø 3.0 - 2.0mm, WL 23cm</i>
<b>LD-200-145</b>	KLEINSASSER Löffelzange oval, spitz, aufgebogen, rechts öffnend, Ø 3.0 - 2.0mm, AL 23cm <i>KLEINSASSER spoon forceps oval, pointed, upcurved, right side open, Ø 3.0 - 2.0mm, WL 23cm</i>
<b>LD-200-146</b>	KLEINSASSER Löffelzange oval, spitz, aufgebogen, links öffnend, Ø 3.0 - 2.0mm, AL 23cm <i>KLEINSASSER spoon forceps oval, pointed, upcurved, left side open, Ø 3.0 - 2.0mm, WL 23cm</i>
<b>LD-200-147</b>	KLEINSASSER Fasszange, herzform, gerade, Ø 3.0 - 2.0mm, AL 23cm <i>KLEINSASSER grasping forceps, heart shaped, straight, Ø 3.0 - 2.0mm, WL 23cm</i>
<b>LD-200-148</b>	KLEINSASSER Fasszange, herzform, rechts gebogen, Ø 3.0 - 2.0mm, AL 23cm <i>KLEINSASSER grasping forceps, heart shaped, right curved, Ø 3.0 - 2.0mm, WL 23cm</i>
<b>LD-200-149</b>	KLEINSASSER Fasszange, herzform, links gebogen, Ø 3.0 - 2.0mm, AL 23cm <i>KLEINSASSER grasping forceps, heart shaped, left curved, Ø 3.0 - 2.0mm, WL 23cm</i>
<b>LD-200-150</b>	KLEINSASSER Fasszange, herzform, aufgebogen, Ø 3.0 - 2.0mm, AL 23cm <i>KLEINSASSER grasping forceps, heart shaped, upcurved, Ø 3.0 - 2.0mm, WL 23cm</i>
<b>LD-200-151</b>	KLEINSASSER Fasszange, herzform, 45° aufgebogen rechts, Ø 3.0 - 2.0mm, AL 23cm <i>KLEINSASSER grasping forceps, heart shaped, 45° upcurved right, Ø 3.0 - 2.0mm, WL 23cm</i>
<b>LD-200-152</b>	KLEINSASSER Fasszange, herzform, 45° aufgebogen links, Ø 3.0 - 2.0mm, AL 23cm <i>KLEINSASSER grasping forceps, heart shaped, 45° up curved left, Ø 3.0 - 2.0mm, WL 23cm</i>
<b>LD-200-153</b>	KLEINSASSER Fasszange, herzform, nach oben öffnend, Ø 3.0 - 2.0mm, AL 23cm <i>KLEINSASSER grasping forceps, heart shaped, open upward, Ø 3.0 - 2.0mm, WL 23cm</i>
<b>LD-200-154</b>	KLEINSASSER Fasszange, herzform, nach unten öffnend, Ø 3.0 - 2.0mm, AL 23cm <i>KLEINSASSER grasping forceps, heart shaped, open downward, Ø 3.0 - 2.0mm, WL 23cm</i>

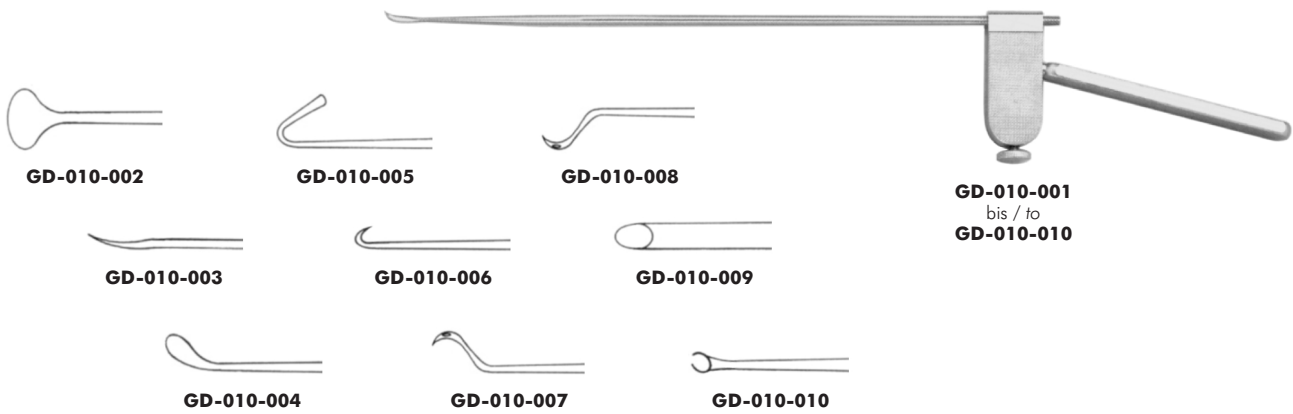

Bestell-Nr. Ordering no.	Bezeichnung Description
<b>GD-010-001</b>	KLEINSASSER Handgriff, allein <i>KLEINSASSER handle, only</i>
<b>GD-010-002</b>	Messer oval, gerade <i>Knife oval, straight</i>
<b>GD-010-003</b>	Sichelmesser <i>Sickle knife</i>
<b>GD-010-004</b>	Messer golfstockförmig <i>Knife golf club shaped</i>
<b>GD-010-005</b>	Haken stumpf, mit Sondenkopf <i>Hook blunt, with probe head</i>
<b>GD-010-006</b>	Haken scharf <i>Hook sharp</i>
<b>GD-010-007</b>	Umstechungsnadel, nach rechts gebogen <i>Needle, curved right</i>
<b>GD-010-008</b>	Umstechungsnadel, nach links gebogen <i>Needle, curved left</i>
<b>GD-010-009</b>	Saugraspatorium <i>Suction tube</i>
<b>GD-010-010</b>	Knotenführer <i>Knot pusher</i>

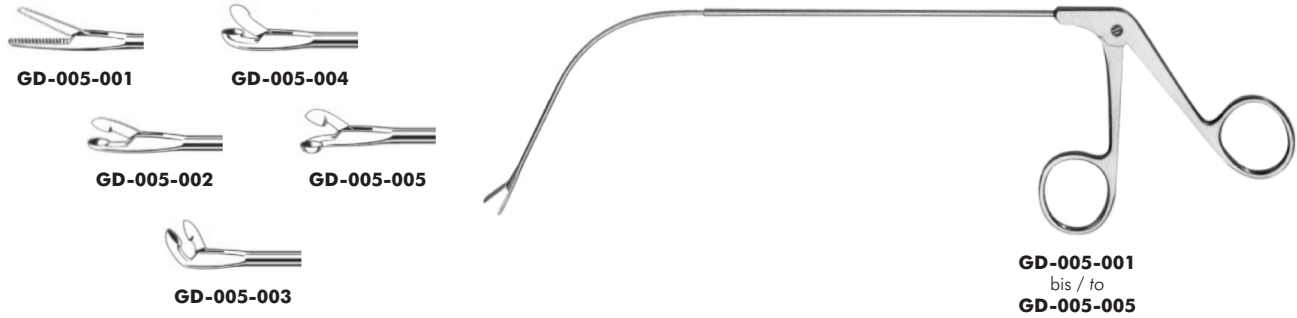

<b>Bestell-Nr.</b> <b>Ordering no.</b>	<b>Bezeichnung</b> <b>Description</b>
<b>GD-005-001</b>	Kehlkopfzange gerade gerieft, Ø 3-2mm, Schaft gebogen, AL 170mm <i>Larynx forceps straight serrated, Ø 3-2mm, tube curved, WL 170mm</i>
<b>GD-005-002</b>	Kehlkopflöffelzange gerade, Ø 3-2mm, Schaft gebogen, AL 170mm <i>Larynx spoon forceps straight, Ø 3-2mm, tube curved, WL 170mm</i>
<b>GD-005-003</b>	Kehlkopflöffelzange aufgebogen, Ø 3-2mm, Schaft gebogen, AL 170mm <i>Larynx spoon forceps upcurved, Ø 3-2mm, tube curved, WL 170mm</i>
<b>GD-005-004</b>	Kehlkopflöffelzange rechtsgebogen, Ø 3-2mm, Schaft gebogen, AL 170mm <i>Larynx spoon forceps curved right, Ø 3-2mm, tube curved, WL 170mm</i>
<b>GD-005-005</b>	Kehlkopflöffelzange linksgebogen, Ø 3-2mm, Schaft gebogen, AL 170mm <i>Larynx spoon forceps curved left, Ø 3-2mm, tube curved, WL 170mm</i>



GD-005-013



GD-005-010



GD-005-011



GD-005-012

Bestell-Nr. Ordering no.	Bezeichnung Description
GD-005-010	KLEINSASSER Nadelhalter gerade, Ø 3-2mm, AL 230mm KLEINSASSER needleholder straight, Ø 3-2mm, WL 230mm
GD-005-011	Stimmbandspreizer, Ø 3-2mm, AL 230mm Vocal cord spreader, Ø 3-2mm, WL 230mm
GD-005-012	Applikator für Stimmbandspreizer-Einsatz, Ø 4.5mm, AL 250mm Applicator for vocal cord spreader insert, Ø 4.5mm, WL 250mm
GD-005-013	Spreizer mit Feder Spreader with spring

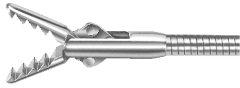

**DA-001-001**  
bis / to  
**DA-003-001**



**DC-001-001**  
bis / to  
**DC-003-001**



**DA-001-000**  
bis / to  
**DC-003-001**

<b>Bestell-Nr.</b> <b>Ordering no.</b>	<b>Bezeichnung</b> <b>Description</b>
<b>DA-001-000</b>	Alligator Zange, Ø 1.0mm, Länge 60cm <i>Alligator forceps, Ø 1.0mm, length 60cm</i>
<b>DA-001-001</b>	Alligator Zange, Ø 1.0mm, Länge 120cm <i>Alligator forceps, Ø 1.0mm, length 120cm</i>
<b>DA-003-000</b>	Alligator Zange, Ø 1.6mm, Länge 60cm <i>Alligator forceps, Ø 1.6mm, length 60cm</i>
<b>DA-003-001</b>	Alligator Zange, Ø 1.6mm, Länge 120cm <i>Alligator forceps, Ø 1.6mm, length 120cm</i>
<b>DC-001-000</b>	Biopsiezange langer ovaler Löffel mit Fenster, Ø 1.0mm, Länge 60cm <i>Biopsy forceps, long oval cup fenestrated, Ø 1.0mm, length 60cm</i>
<b>DC-001-001</b>	Biopsiezange langer ovaler Löffel mit Fenster, Ø 1.0mm, Länge 120cm <i>Biopsy forceps, long oval cup fenestrated, Ø 1.0mm, length 120cm</i>
<b>DC-003-000</b>	Biopsiezange langer ovaler Löffel mit Fenster, Ø 1.6mm, Länge 60cm <i>Biopsy forceps, long oval cup fenestrated, Ø 1.6mm, length 60cm</i>
<b>DC-003-001</b>	Biopsiezange langer ovaler Löffel mit Fenster, Ø 1.6mm, Länge 120cm <i>Biopsy forceps, long oval cup fenestrated, Ø 1.6mm, length 120cm</i>



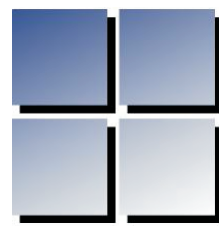

**STEMA**

Medizintechnik GmbH

**CHIRURGIE**

**SURGERY**









LD-004-260



ZA-001-886



ZA-001-881



ZA-001-882



ZA-004-185

Bestell-Nr. Ordering no.	Bezeichnung Description
ZA-001-881	Skalpellegriff Nr. 3 mit cm-Graduierung, 12.5cm Scalpel handle no. 3 with cm-graduation, 12.5cm
ZA-001-882	Skalpellegriff Nr. 3, 12.5cm Scalpel handle no. 3, 12.5cm
ZA-001-886	Skalpellegriff Nr. 7, 16cm Scalpel handle no. 7, 16cm
ZA-004-185	Mikro-Skalpellegriff, rund, 12.5cm, für Klingen 62, 64, 86, 87 Micro scalpel handle, rund, 12.5cm, used for blades 62, 64, 86, 87
LD-004-260	SCHINK Dermatom, komplett, 30.5cm SCHINK dermatome, complete, 30.5cm



**ZA-001-533**  
bis / to  
**ZA-001-541**



**ZA-001-542**  
bis / to  
**ZA-001-550**



**ZA-001-533**  
bis / to  
**ZA-001-550**

<b>Bestell-Nr.</b> <b>Ordering no.</b>	<b>Bezeichnung</b> <b>Description</b>
<b>ZA-001-533</b>	Standard OP-Schere, gerade, st./st., 10.5cm Standard operating scissors, straight, bl./bl., 10.5cm
<b>ZA-001-534</b>	Standard OP-Schere, gerade, st./st., 11.5cm Standard operating scissors, straight, bl./bl., 11.5cm
<b>ZA-001-535</b>	Standard OP-Schere, gerade, st./st., 13cm Standard operating scissors, straight, bl./bl., 13cm
<b>ZA-001-536</b>	Standard OP-Schere, gerade, st./st., 14.5cm Standard operating scissors, straight, bl./bl., 14.5cm
<b>ZA-001-537</b>	Standard OP-Schere, gerade, st./st., 15.5cm Standard operating scissors, straight, bl./bl., 15.5cm
<b>ZA-001-538</b>	Standard OP-Schere, gerade, st./st., 16.5cm Standard operating scissors, straight, bl./bl., 16.5cm
<b>ZA-001-539</b>	Standard OP-Schere, gerade, st./st., 17.5cm Standard operating scissors, straight, bl./bl., 17.5cm
<b>ZA-001-540</b>	Standard OP-Schere, gerade, st./st., 18.5cm Standard operating scissors, straight, bl./bl., 18.5cm
<b>ZA-001-541</b>	Standard OP-Schere, gerade, st./st., 20cm Standard operating scissors, straight, bl./bl., 20cm
<b>ZA-001-542</b>	Standard OP-Schere, gebogen, st./st., 10.5cm Standard operating scissors, curved, bl./bl., 10.5cm
<b>ZA-001-543</b>	Standard OP-Schere, gebogen, st./st., 11.5cm Standard operating scissors, curved, bl./bl., 11.5cm
<b>ZA-001-544</b>	Standard OP-Schere, gebogen, st./st., 13cm Standard operating scissors, curved, bl./bl., 13cm
<b>ZA-001-545</b>	Standard OP-Schere, gebogen, st./st., 14.5cm Standard operating scissors, curved, bl./bl., 14.5cm
<b>ZA-001-546</b>	Standard OP-Schere, gebogen, st./st., 15.5cm Standard operating scissors, curved, bl./bl., 15.5cm
<b>ZA-001-547</b>	Standard OP-Schere, gebogen, st./st., 16.5cm Standard operating scissors, curved, bl./bl., 16.5cm
<b>ZA-001-548</b>	Standard OP-Schere, gebogen, st./st., 17.5cm Standard operating scissors, curved, bl./bl., 17.5cm
<b>ZA-001-549</b>	Standard OP-Schere, gebogen, st./st., 18.5cm Standard operating scissors, curved, bl./bl., 18.5cm
<b>ZA-001-550</b>	Standard OP-Schere, gebogen, st./st., 20cm Standard operating scissors, curved, bl./bl., 20cm



**ZA-001-551**  
bis / to  
**ZA-001-561**



**ZA-001-562**  
bis / to  
**ZA-001-572**



**ZA-001-551**  
bis / to  
**ZA-001-572**

Bestell-Nr. Ordering no.	Bezeichnung Description
<b>ZA-001-551</b>	Standard OP-Schere, gerade, sp./st., 10.5cm Standard operating scissors, straight, sh./bl., 10.5cm
<b>ZA-001-552</b>	Standard OP-Schere, gerade, sp./st., 11.5cm Standard operating scissors, straight, sh./bl., 11.5cm
<b>ZA-001-553</b>	Standard OP-Schere, gerade, sp./st., 13cm Standard operating scissors, straight, sh./bl., 13cm
<b>ZA-001-554</b>	Standard OP-Schere, gerade, sp./st., 13cm, TC Standard operating scissors, straight, sh./bl., 13cm, TC
<b>ZA-001-555</b>	Standard OP-Schere, gerade, sp./st., 14.5cm Standard operating scissors, straight, sh./bl., 14.5cm
<b>ZA-001-556</b>	Standard OP-Schere, gerade, sp./st., 14.5cm, TC Standard operating scissors, straight, sh./bl., 14.5cm, TC
<b>ZA-001-557</b>	Standard OP-Schere, gerade, sp./st., 15.5cm Standard operating scissors, straight, sh./bl., 15.5cm
<b>ZA-001-558</b>	Standard OP-Schere, gerade, sp./st., 16.5cm Standard operating scissors, straight, sh./bl., 16.5cm
<b>ZA-001-559</b>	Standard OP-Schere, gerade, sp./st., 17.5cm Standard operating scissors, straight, sh./bl., 17.5cm
<b>ZA-001-560</b>	Standard OP-Schere, gerade, sp./st., 18.5cm Standard operating scissors, straight, sh./bl., 18.5cm
<b>ZA-001-561</b>	Standard OP-Schere, gerade, sp./st., 20cm Standard operating scissors, straight, sh./bl., 20cm
<b>ZA-001-562</b>	Standard OP-Schere, gebogen, sp./st., 10.5cm Standard operating scissors, curved, sh./bl., 10.5cm
<b>ZA-001-563</b>	Standard OP-Schere, gebogen, sp./st., 11.5cm Standard operating scissors, curved, sh./bl., 11.5cm
<b>ZA-001-564</b>	Standard OP-Schere, gebogen, sp./st., 13cm Standard operating scissors, curved, sh./bl., 13cm
<b>ZA-001-565</b>	Standard OP-Schere, gebogen, sp./st., 13cm, TC Standard operating scissors, curved, sh./bl., 13cm, TC
<b>ZA-001-566</b>	Standard OP-Schere, gebogen, sp./st., 14.5cm Standard operating scissors, curved, sh./bl., 14.5cm
<b>ZA-001-567</b>	Standard OP-Schere, gebogen, sp./st., 14.5cm, TC Standard operating scissors, curved, sh./bl., 14.5cm, TC
<b>ZA-001-568</b>	Standard OP-Schere, gebogen, sp./st., 15.5cm Standard operating scissors, curved, sh./bl., 15.5cm
<b>ZA-001-569</b>	Standard OP-Schere, gebogen, sp./st., 16.5cm Standard operating scissors, curved, sh./bl., 16.5cm
<b>ZA-001-570</b>	Standard OP-Schere, gebogen, sp./st., 17.5cm Standard operating scissors, curved, sh./bl., 17.5cm
<b>ZA-001-571</b>	Standard OP-Schere, gebogen, sp./st., 18.5cm Standard operating scissors, curved, sh./bl., 18.5cm
<b>ZA-001-572</b>	Standard OP-Schere, gebogen, sp./st., 20cm Standard operating scissors, curved, sh./bl., 20cm



**ZA-001-573**  
bis / to  
**ZA-001-581**



**ZA-001-582**  
bis / to  
**ZA-001-590**



**ZA-001-573**  
bis / to  
**ZA-001-590**

<b>Bestell-Nr.</b> <b>Ordering no.</b>	<b>Bezeichnung</b> <b>Description</b>
<b>ZA-001-573</b>	Standard OP-Schere, gerade, sp./sp., 10.5cm <i>Standard operating scissors, straight, sh./sh., 10.5cm</i>
<b>ZA-001-574</b>	Standard OP-Schere, gerade, sp./sp., 11.5cm <i>Standard operating scissors, straight, sh./sh., 11.5cm</i>
<b>ZA-001-575</b>	Standard OP-Schere, gerade, sp./sp., 13cm <i>Standard operating scissors, straight, sh./sh., 13cm</i>
<b>ZA-001-576</b>	Standard OP-Schere, gerade, sp./sp., 14.5cm <i>Standard operating scissors, straight, sh./sh., 14.5cm</i>
<b>ZA-001-577</b>	Standard OP-Schere, gerade, sp./sp., 15.5cm <i>Standard operating scissors, straight, sh./sh., 15.5cm</i>
<b>ZA-001-578</b>	Standard OP-Schere, gerade, sp./sp., 16.5cm <i>Standard operating scissors, straight, sh./sh., 16.5cm</i>
<b>ZA-001-579</b>	Standard OP-Schere, gerade, sp./sp., 17.5cm <i>Standard operating scissors, straight, sh./sh., 17.5cm</i>
<b>ZA-001-580</b>	Standard OP-Schere, gerade, sp./sp., 18.5cm <i>Standard operating scissors, straight, sh./sh., 18.5cm</i>
<b>ZA-001-581</b>	Standard OP-Schere, gerade, sp./sp., 20cm <i>Standard operating scissors, straight, sh./sh., 20cm</i>
<b>ZA-001-582</b>	Standard OP-Schere, gebogen, sp./sp., 10.5cm <i>Standard operating scissors, curved, sh./sh., 10.5cm</i>
<b>ZA-001-583</b>	Standard OP-Schere, gebogen, sp./sp., 11.5cm <i>Standard operating scissors, curved, sh./sh., 11.5cm</i>
<b>ZA-001-584</b>	Standard OP-Schere, gebogen, sp./sp., 13cm <i>Standard operating scissors, curved, sh./sh., 13cm</i>
<b>ZA-001-585</b>	Standard OP-Schere, gebogen, sp./sp., 14.5cm <i>Standard operating scissors, curved, sh./sh., 14.5cm</i>
<b>ZA-001-586</b>	Standard OP-Schere, gebogen, sp./sp., 15.5cm <i>Standard operating scissors, curved, sh./sh., 15.5cm</i>
<b>ZA-001-587</b>	Standard OP-Schere, gebogen, sp./sp., 16.5cm <i>Standard operating scissors, curved, sh./sh., 16.5cm</i>
<b>ZA-001-588</b>	Standard OP-Schere, gebogen, sp./sp., 17.5cm <i>Standard operating scissors, curved, sh./sh., 17.5cm</i>
<b>ZA-001-589</b>	Standard OP-Schere, gebogen, sp./sp., 18.5cm <i>Standard operating scissors, curved, sh./sh., 18.5cm</i>
<b>ZA-001-590</b>	Standard OP-Schere, gebogen, sp./sp., 20cm <i>Standard operating scissors, curved, sh./sh., 20cm</i>



**ZA-001-610**  
bis / to  
**ZA-001-615 /**  
**ZA-001-622**  
bis / to  
**ZA-001-625**



**ZA-001-616**  
bis / to  
**ZA-001-621 /**  
**ZA-001-626**  
bis / to  
**ZA-001-629**



**ZA-001-610**  
bis / to  
**ZA-001-621**

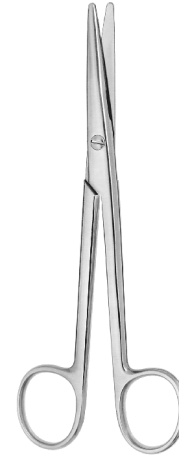

**ZA-001-622**  
bis / to  
**ZA-001-629**

Bestell-Nr. Ordering no.	Bezeichnung Description
<b>ZA-001-610</b>	MAYO OP-Schere, gerade, st./st., 14.5cm MAYO operating scissors, straight, bl./bl., 14.5cm
<b>ZA-001-611</b>	MAYO OP-Schere, gerade, st./st., 14.5cm, TC MAYO operating scissors, straight, bl./bl., 14.5cm, TC
<b>ZA-001-612</b>	MAYO OP-Schere, gerade, st./st., 17cm MAYO operating scissors, straight, bl./bl., 17cm
<b>ZA-001-613</b>	MAYO OP-Schere, gerade, st./st., 17cm, TC MAYO operating scissors, straight, bl./bl., 17cm, TC
<b>ZA-001-614</b>	MAYO OP-Schere, gerade, st./st., 23cm MAYO operating scissors, straight, bl./bl., 23cm
<b>ZA-001-615</b>	MAYO OP-Schere, gerade, st./st., 23cm, TC MAYO operating scissors, straight, bl./bl., 23cm, TC
<b>ZA-001-616</b>	MAYO OP-Schere, gebogen, st./st., 14.5cm MAYO operating scissors, curved, bl./bl., 14.5cm
<b>ZA-001-617</b>	MAYO OP-Schere, gebogen, st./st., 14.5cm, TC MAYO operating scissors, curved, bl./bl., 14.5cm, TC
<b>ZA-001-618</b>	MAYO OP-Schere, gebogen, st./st., 17cm MAYO operating scissors, curved, bl./bl., 17cm
<b>ZA-001-619</b>	MAYO OP-Schere, gebogen, st./st., 17cm, TC MAYO operating scissors, curved, bl./bl., 17cm, TC
<b>ZA-001-620</b>	MAYO OP-Schere, gebogen, st./st., 23cm MAYO operating scissors, curved, bl./bl., 23cm
<b>ZA-001-621</b>	MAYO OP-Schere, gebogen, st./st., 23cm, TC MAYO operating scissors, curved, bl./bl., 23cm, TC
<b>ZA-001-622</b>	MAYO-STILLE OP-Schere, gerade, st./st., 15cm MAYO-STILLE operating scissors, straight, bl./bl., 15cm
<b>ZA-001-623</b>	MAYO-STILLE OP-Schere, gerade, st./st., 17cm MAYO-STILLE operating scissors, straight, bl./bl., 17cm
<b>ZA-001-624</b>	MAYO-STILLE OP-Schere, gerade, st./st., 19cm MAYO-STILLE operating scissors, straight, bl./bl., 19cm
<b>ZA-001-625</b>	MAYO-STILLE OP-Schere, gerade, st./st., 21cm MAYO-STILLE operating scissors, straight, bl./bl., 21cm
<b>ZA-001-626</b>	MAYO-STILLE OP-Schere, gebogen, st./st., 15cm MAYO-STILLE operating scissors, curved, bl./bl., 15cm
<b>ZA-001-627</b>	MAYO-STILLE OP-Schere, gebogen, st./st., 17cm MAYO-STILLE operating scissors, curved, bl./bl., 17cm
<b>ZA-001-628</b>	MAYO-STILLE OP-Schere, gebogen, st./st., 19cm MAYO-STILLE operating scissors, curved, bl./bl., 19cm
<b>ZA-001-629</b>	MAYO-STILLE OP-Schere, gebogen, st./st., 21cm MAYO-STILLE operating scissors, curved, bl./bl., 21cm

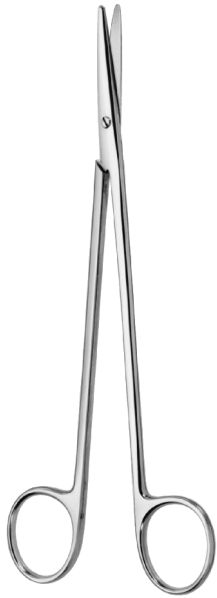

**ZA-001-659**  
bis / to  
**ZA-001-676**



**ZA-001-687 /**  
**ZA-001-688**



**ZA-004-328 /**  
**ZA-004-329**



**ZA-001-657 /**  
**ZA-001-658**



**ZA-001-685 /**  
**ZA-001-686**

Bestell-Nr. Ordering no.	Bezeichnung Description
<b>ZA-001-657</b>	METZENBAUM-BABY Schere, gerade, st./st., 11.5cm METZENBAUM-BABY scissors, straight, bl./bl., 11.5cm
<b>ZA-001-658</b>	METZENBAUM-BABY Schere, gebogen, st./st., 11.5cm METZENBAUM-BABY scissors, curved, bl./bl., 11.5cm
<b>ZA-001-659</b>	METZENBAUM-NELSON Schere, gerade, st./st., 18cm METZENBAUM-NELSON scissors, straight, bl./bl., 18cm
<b>ZA-001-661</b>	METZENBAUM-NELSON Schere, gerade, st./st., 20cm METZENBAUM-NELSON scissors, straight, bl./bl., 20cm
<b>ZA-001-663</b>	METZENBAUM-NELSON Schere, gerade, st./st., 23cm METZENBAUM-NELSON scissors, straight, bl./bl., 23cm
<b>ZA-001-665</b>	METZENBAUM-NELSON Schere, gerade, st./st., 25cm METZENBAUM-NELSON scissors, straight, bl./bl., 25cm
<b>ZA-001-666</b>	METZENBAUM-NELSON Schere, gerade, st./st., 28cm METZENBAUM-NELSON scissors, straight, bl./bl., 28cm
<b>ZA-001-667</b>	METZENBAUM-NELSON Schere, gerade, st./st., 30cm METZENBAUM-NELSON scissors, straight, bl./bl., 30cm
<b>ZA-001-668</b>	METZENBAUM-NELSON Schere, gebogen, st./st., 18cm METZENBAUM-NELSON scissors, curved, bl./bl., 18cm
<b>ZA-001-670</b>	METZENBAUM-NELSON Schere, gebogen, st./st., 20cm METZENBAUM-NELSON scissors, curved, bl./bl., 20cm
<b>ZA-001-672</b>	METZENBAUM-NELSON Schere, gebogen, st./st., 23cm METZENBAUM-NELSON scissors, curved, bl./bl., 23cm
<b>ZA-001-674</b>	METZENBAUM-NELSON Schere, gebogen, st./st., 25cm METZENBAUM-NELSON scissors, curved, bl./bl., 25cm
<b>ZA-001-675</b>	METZENBAUM-NELSON Schere, gebogen, st./st., 28cm METZENBAUM-NELSON scissors, curved, bl./bl., 28cm
<b>ZA-001-676</b>	METZENBAUM-NELSON Schere, gebogen, st./st., 30cm METZENBAUM-NELSON scissors, curved, bl./bl., 30cm
<b>ZA-001-685</b>	LEXER-BABY Schere, gerade, st./st., 10cm LEXER-BABY scissors, straight, bl./bl., 10cm
<b>ZA-001-686</b>	LEXER-BABY Schere, gebogen, st./st., 10cm LEXER-BABY scissors, curved, bl./bl., 10cm
<b>ZA-001-687</b>	JOSEPH Schere, gerade, sp./sp., 14cm JOSEPH scissors, straight, sh./sh., 14cm
<b>ZA-001-688</b>	JOSEPH Schere, gebogen, sp./sp., 14cm JOSEPH scissors, curved, sh./sh., 14cm
<b>ZA-004-328</b>	JOSEPH Schere, gerade, sp./sp., 14cm, TC JOSEPH scissors, straight, sh./sh., 14cm, TC
<b>ZA-004-329</b>	JOSEPH Schere, gebogen, sp./sp., 14cm, TC JOSEPH scissors, curved, sh./sh., 14cm, TC



**ZA-001-706**



**ZA-001-689 /  
ZA-001-690**



**ZA-004-370 /  
ZA-004-551**



**ZA-001-719 /  
ZA-001-720**



**ZA-001-725**

<b>Bestell-Nr. Ordering no.</b>	<b>Bezeichnung Description</b>
<b>ZA-001-689</b>	KILNER Schere, gebogen, 12cm <i>KILNER scissors, curved, 12cm</i>
<b>ZA-001-690</b>	KILNER Schere, gebogen, 15cm <i>KILNER scissors, curved, 15cm</i>
<b>ZA-004-370</b>	KILNER Schere, gebogen, 13cm, TC <i>KILNER scissors, curved, 13cm, TC</i>
<b>ZA-004-551</b>	KILNER Schere, gebogen, 15cm, TC <i>KILNER scissors, curved, 15cm, TC</i>
<b>ZA-001-706</b>	MCINDOE Schere, gerade, 19cm <i>MCINDOE scissors, straight, 19cm</i>
<b>ZA-001-719</b>	WAGNER Schere, gebogen, fein, st./sp., 12cm <i>WAGNER scissors, curved, fine, bl./sh., 12cm</i>
<b>ZA-001-720</b>	WAGNER Schere, gebogen, fein, sp./sp., 12cm <i>WAGNER scissors, curved, fine, sh./sh., 12cm</i>
<b>ZA-001-725</b>	LITTLER Schere, gebogen, fein, 11.5cm <i>LITTLER scissors, curved, fine, 11.5cm</i>





**ZA-001-834**  
bis / to  
**ZA-001-840**



**ZA-004-366 /**  
**ZA-001-796 /**  
**ZA-004-367**



**ZA-001-721**  
bis / to  
**ZA-001-724**



**ZA-004-371**  
bis / to  
**ZA-004-374**



**ZA-004-375**  
bis / to  
**ZA-004-378**

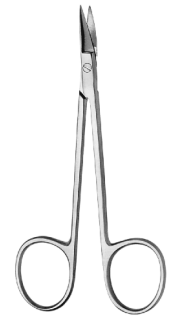

**ZA-004-380**

<b>Bestell-Nr.</b> <b>Ordering no.</b>	<b>Bezeichnung</b> <b>Description</b>
<b>ZA-001-721</b>	Schere, gerade, fein, sp./sp., 11cm Scissors, straight, fine, sh./sh., 11cm
<b>ZA-001-723</b>	Schere, gerade, fein, sp./sp., 11.5cm Scissors, straight, fine, sh./sh., 11.5cm
<b>ZA-001-722</b>	Schere, gebogen, fein, sp./sp., 11cm Scissors, curved, fine, sh./sh., 11cm
<b>ZA-001-724</b>	Schere, gebogen, fein, sp./sp., 11.5cm Scissors, curved, fine, sh./sh., 11.5cm
<b>ZA-004-366</b>	GOLDMAN-FOX Schere, gerade, fein, 13cm, TC GOLDMAN-FOX scissors, straight, fine, 13cm, TC
<b>ZA-001-796</b>	GOLDMAN-FOX Schere, gebogen, fein, 13cm, TC GOLDMAN-FOX scissors, curved, fine, 13cm, TC
<b>ZA-004-367</b>	GOLDMAN-FOX Schere, gebogen, fein, "SuperCut" Schneiden, 13cm, TC GOLDMAN-FOX scissors, curved, fine, "SuperCut" blades, 13cm, TC
<b>ZA-001-834</b>	MAYO-STILLE Schere, gerade, st./st., 15cm, TC MAYO-STILLE scissors, straight, bl./bl., 15cm, TC
<b>ZA-001-836</b>	MAYO-STILLE Schere, gerade, st./st., 17cm, TC MAYO-STILLE scissors, straight, bl./bl., 17cm, TC
<b>ZA-001-838</b>	MAYO-STILLE Schere, gebogen, st./st., 15cm, TC MAYO-STILLE scissors, curved, bl./bl., 15cm, TC
<b>ZA-001-840</b>	MAYO-STILLE Schere, gebogen, st./st., 17cm, TC MAYO-STILLE scissors, curved, bl./bl., 17cm, TC
<b>ZA-004-546</b>	WILMER Schere, abgewinkelt, 10cm WILMER scissors, angled, 10cm
<b>ZA-004-371</b>	Feine Schere, gerade, st./st., 10.5cm Fine scissors, straight, bl./bl., 10.5cm
<b>ZA-004-373</b>	Feine Schere, gerade, st./st., 11.5cm Fine scissors, straight, bl./bl., 11.5cm
<b>ZA-004-372</b>	Feine Schere, gebogen, st./st., 10.5cm Fine scissors, curved, bl./bl., 10.5cm
<b>ZA-004-374</b>	Feine Schere, gebogen, st./st., 11.5cm Fine scissors, curved, bl./bl., 11.5cm
<b>ZA-004-375</b>	Feine Schere, gerade, st./st., 11.5cm, TC Fine scissors, straight, bl./bl., 11.5cm, TC
<b>ZA-004-377</b>	Feine Schere, gerade, sp./sp., 11.5cm, TC Fine scissors, straight, sh./sh., 11.5cm, TC
<b>ZA-004-376</b>	Feine Schere, gebogen, st./st., 11.5cm, TC Fine scissors, curved, bl./bl., 11.5cm, TC
<b>ZA-004-378</b>	Feine Schere, gebogen, sp./sp., 11.5cm, TC Fine scissors, curved, sh./sh., 11.5cm, TC



**ZA-004-526**  
bis / to  
**ZA-004-529**



**ZA-004-513**  
bis / to  
**ZA-004-518**



**ZA-004-519**  
bis / to  
**ZA-004-522**



**ZA-004-530**  
bis / to  
**ZA-004-533**



**ZA-004-534 /**  
**ZA-004-535**

Bestell-Nr. Ordering no.	Bezeichnung Description
<b>ZA-004-513</b>	METZENBAUM-FINO Schere, gerade, st./st., 20cm METZENBAUM-FINO scissors, straight, bl./bl., 20cm
<b>ZA-004-514</b>	METZENBAUM-FINO Schere, gerade, st./st., 23cm METZENBAUM-FINO scissors, straight, bl./bl., 23cm
<b>ZA-004-515</b>	METZENBAUM-FINO Schere, gerade, st./st., 25cm METZENBAUM-FINO scissors, straight, bl./bl., 25cm
<b>ZA-004-516</b>	METZENBAUM-FINO Schere, gebogen, st./st., 20cm METZENBAUM-FINO scissors, curved, bl./bl., 20cm
<b>ZA-004-517</b>	METZENBAUM-FINO Schere, gebogen, st./st., 23cm METZENBAUM-FINO scissors, curved, bl./bl., 23cm
<b>ZA-004-518</b>	METZENBAUM-FINO Schere, gebogen, st./st., 25cm METZENBAUM-FINO scissors, curved, bl./bl., 25cm
<b>ZA-004-519</b>	METZENBAUM-FINO Schere, gerade, st./st., 23cm, TC METZENBAUM-FINO scissors, straight, bl./bl., 23cm, TC
<b>ZA-004-520</b>	METZENBAUM-FINO Schere, gerade, st./st., 25cm, TC METZENBAUM-FINO scissors, straight, bl./bl., 25cm, TC
<b>ZA-004-521</b>	METZENBAUM-FINO Schere, gebogen, st./st., 23cm, TC METZENBAUM-FINO scissors, curved, bl./bl., 23cm, TC
<b>ZA-004-522</b>	METZENBAUM-FINO Schere, gebogen, st./st., 25cm, TC METZENBAUM-FINO scissors, curved, bl./bl., 25cm, TC
<b>ZA-004-526</b>	METZENBAUM Schere, gerade, st./st., 25cm, TC METZENBAUM scissors, straight, bl./bl., 25cm, TC
<b>ZA-004-527</b>	METZENBAUM Schere, gerade, st./st., 30cm, TC METZENBAUM scissors, straight, bl./bl., 30cm, TC
<b>ZA-004-528</b>	METZENBAUM Schere, gebogen, st./st., 25cm, TC METZENBAUM scissors, curved, bl./bl., 25cm, TC
<b>ZA-004-529</b>	METZENBAUM Schere, gebogen, st./st., 30cm, TC METZENBAUM scissors, curved, bl./bl., 30cm, TC
<b>ZA-004-530</b>	MAYO Schere, gerade, st./st., 19cm MAYO scissors, straight, bl./bl., 19cm
<b>ZA-004-532</b>	MAYO Schere, gerade, st./st., 30cm MAYO scissors, straight, bl./bl., 30cm
<b>ZA-004-531</b>	MAYO Schere, gebogen, st./st., 19cm MAYO scissors, curved, bl./bl., 19cm
<b>ZA-004-533</b>	MAYO Schere, gebogen, st./st., 30cm MAYO scissors, curved, bl./bl., 30cm
<b>ZA-004-534</b>	MAYO Schere, gerade, st./st., 20cm, TC MAYO scissors, straight, bl./bl., 20cm, TC
<b>ZA-004-535</b>	MAYO Schere, gebogen, st./st., 20cm, TC MAYO scissors, curved, bl./bl., 20cm, TC



**ZA-001-848**  
bis / to  
**ZA-001-858**

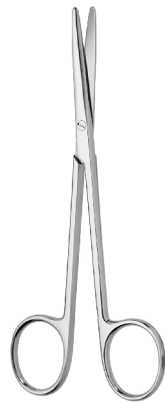

**ZA-001-649**  
bis / to  
**ZA-001-721**



**ZA-001-844**  
bis / to  
**ZA-001-858**



**ZA-001-677**  
bis / to  
**ZA-001-682**



**ZA-001-862**  
bis / to  
**ZA-001-874**

Bestell-Nr. Ordering no.	Bezeichnung Description
<b>ZA-001-649</b>	METZENBAUM Präparierschere, gerade, st./st., 14.5cm METZENBAUM dissecting scissors, straight, bl./bl., 14.5cm
<b>ZA-001-651</b>	METZENBAUM Präparierschere, gebogen, st./st., 14.5cm METZENBAUM dissecting scissors, curved, bl./bl., 14.5cm
<b>ZA-004-720</b>	METZENBAUM Präparierschere, gebogen, st./st., 18cm METZENBAUM dissecting scissors, curved, bl./bl., 18cm
<b>ZA-004-721</b>	METZENBAUM Präparierschere, gebogen, st./st., 20cm METZENBAUM dissecting scissors, curved, bl./bl., 20cm
<b>ZA-001-848</b>	METZENBAUM Präparierschere, gerade, st./st., 18cm, TC METZENBAUM dissecting scissors, straight, bl./bl., 18cm, TC
<b>ZA-001-850</b>	METZENBAUM Präparierschere, gerade, st./st., 20cm, TC METZENBAUM dissecting scissors, straight, bl./bl., 20cm, TC
<b>ZA-001-852</b>	METZENBAUM Präparierschere, gerade, st./st., 23cm, TC METZENBAUM dissecting scissors, straight, bl./bl., 23cm, TC
<b>ZA-001-844</b>	METZENBAUM-FINO Präparierschere, gerade, st./st., 14.5cm, TC METZENBAUM-FINO dissecting scissors, straight, bl./bl., 14.5cm, TC
<b>ZA-001-846</b>	METZENBAUM-FINO Präparierschere, gebogen, st./st., 14.5cm, TC METZENBAUM-FINO dissecting scissors, curved, bl./bl., 14.5cm, TC
<b>ZA-001-854</b>	METZENBAUM-FINO Präparierschere, gebogen, st./st., 18cm, TC METZENBAUM-FINO dissecting scissors, curved, bl./bl., 18cm, TC
<b>ZA-001-856</b>	METZENBAUM-FINO Präparierschere, gebogen, st./st., 20.5cm, TC METZENBAUM-FINO dissecting scissors, curved, bl./bl., 20.5cm, TC
<b>ZA-001-858</b>	METZENBAUM-FINO Präparierschere, gebogen, st./st., 23cm, TC METZENBAUM-FINO dissecting scissors, curved, bl./bl., 23cm, TC
<b>ZA-001-677</b>	METZENBAUM-FINO Präparierschere, gerade, schlank, st./st., 14.5cm METZENBAUM-FINO dissecting scissors, straight, delicate, bl./bl., 14.5cm
<b>ZA-001-681</b>	METZENBAUM-FINO Präparierschere, gerade, schlank, st./st., 18cm METZENBAUM-FINO dissecting scissors, straight, delicate, bl./bl., 18cm
<b>ZA-001-678</b>	METZENBAUM-FINO Präparierschere, gebogen, schlank, st./st., 14.5cm METZENBAUM-FINO dissecting scissors, curved, delicate, bl./bl., 14.5cm
<b>ZA-001-682</b>	METZENBAUM-FINO Präparierschere, gebogen, schlank, st./st., 18cm METZENBAUM-FINO dissecting scissors, curved, delicate, bl./bl., 18cm
<b>ZA-001-862</b>	METZENBAUM-FINO Präparierschere, gerade, schlank, st./st., 14.5cm, TC METZENBAUM-FINO dissecting scissors, straight, delicate, bl./bl., 14.5cm, TC
<b>ZA-001-868</b>	METZENBAUM-FINO Präparierschere, gerade, schlank, st./st., 18cm, TC METZENBAUM-FINO dissecting scissors, straight, delicate, bl./bl., 18cm, TC
<b>ZA-001-864</b>	METZENBAUM-FINO Präparierschere, gebogen, schlank, st./st., 14.5cm, TC METZENBAUM-FINO dissecting scissors, curved, delicate, bl./bl., 14.5cm, TC
<b>ZA-001-872</b>	METZENBAUM-FINO Präparierschere, gebogen, schlank, st./st., 18cm, TC METZENBAUM-FINO dissecting scissors, curved, delicate, bl./bl., 18cm, TC
<b>ZA-001-874</b>	METZENBAUM-FINO Präparierschere, gebogen, schlank, st./st., 20.5cm, TC METZENBAUM-FINO dissecting scissors, curved, delicate, bl./bl., 20.5cm, TC



**ZA-004-544 /  
ZA-004-545**



**ZA-001-683 /  
ZA-001-684**



**ZA-001-860 /  
ZA-001-861**



**ZA-001-691 /  
ZA-001-692**

<b>Bestell-Nr. Ordering no.</b>	<b>Bezeichnung Description</b>
<b>ZA-001-683</b>	LEXER Präparierschere, gerade, fein, 16cm <i>LEXER dissecting scissors, straight, delicate, 16cm</i>
<b>ZA-001-684</b>	LEXER Präparierschere, gebogen, fein, 16cm <i>LEXER dissecting scissors, curved, delicate, 16cm</i>
<b>ZA-001-860</b>	LEXER Präparierschere, gerade, fein, 16cm, TC <i>LEXER dissecting scissors, straight, delicate, 16cm, TC</i>
<b>ZA-001-861</b>	LEXER Präparierschere, gebogen, fein, 16cm, TC <i>LEXER dissecting scissors, curved, delicate, 16cm, TC</i>
<b>ZA-004-544</b>	REYNOLDS Präparierschere, gerade, 18cm <i>REYNOLDS dissecting scissors, straight, 18cm</i>
<b>ZA-004-545</b>	REYNOLDS Präparierschere, gebogen, 18cm <i>REYNOLDS dissecting scissors, curved, 18cm</i>
<b>ZA-001-691</b>	REYNOLDS Präparierschere, gerade, fein, 15cm <i>REYNOLDS dissecting scissors, straight, delicate, 15cm</i>
<b>ZA-001-692</b>	REYNOLDS Präparierschere, gebogen, fein, 15cm <i>REYNOLDS dissecting scissors, curved, delicate, 15cm</i>



**ZA-004-523 /**  
**ZA-004-524**



**ZA-004-525**



**ZA-001-807 /**  
**ZA-001-808**



**ZA-001-742**  
 bis / to  
**ZA-001-749**

<b>Bestell-Nr.</b> <b>Ordering no.</b>	<b>Bezeichnung</b> <b>Description</b>
<b>ZA-001-742</b>	STEVENS Gefäß- und Sehnenschere, gerade, spitz, 10.5cm STEVENS vascular and tenotomy scissors, straight, sharp, 10.5cm
<b>ZA-001-743</b>	STEVENS Gefäß- und Sehnenschere, gerade, spitz, 11.5cm STEVENS vascular and tenotomy scissors, straight, sharp, 11.5cm
<b>ZA-001-744</b>	STEVENS Gefäß- und Sehnenschere, gebogen, spitz, 10.5cm STEVENS vascular and tenotomy scissors, curved, sharp, 10.5cm
<b>ZA-001-745</b>	STEVENS Gefäß- und Sehnenschere, gebogen, spitz, 11.5cm STEVENS vascular and tenotomy scissors, curved, sharp, 11.5cm
<b>ZA-001-746</b>	STEVENS Gefäß- und Sehnenschere, gerade, stumpf, 10.5cm STEVENS vascular and tenotomy scissors, straight, blunt, 10.5cm
<b>ZA-001-747</b>	STEVENS Gefäß- und Sehnenschere, gerade, stumpf, 11.5cm STEVENS vascular and tenotomy scissors, straight, blunt, 11.5cm
<b>ZA-001-748</b>	STEVENS Gefäß- und Sehnenschere, gebogen, stumpf, 10.5cm STEVENS vascular and tenotomy scissors, curved, blunt, 10.5cm
<b>ZA-001-749</b>	STEVENS Gefäß- und Sehnenschere, gebogen, stumpf, 11.5cm STEVENS vascular and tenotomy scissors, curved, blunt, 11.5cm
<b>ZA-001-807</b>	WESTCOTT Sehnenschere, gebogen, spitz, 11cm WESTCOTT tenotomy scissors, curved, sharp, 11cm
<b>ZA-001-808</b>	WESTCOTT Sehnenschere, gebogen, stumpf, 11cm WESTCOTT tenotomy scissors, curved, blunt, 11cm
<b>ZA-004-523</b>	TÖNIS-ADSON Gefäßschere, gerade, st./st., 18cm TÖNIS-ADSON vascular scissors, straight, bl./bl., 18cm
<b>ZA-004-524</b>	TÖNIS-ADSON Gefäßschere, gebogen, st./st., 18cm TÖNIS-ADSON vascular scissors, curved, bl./bl., 18cm
<b>ZA-004-525</b>	TÖNIS-ADSON Gefäßschere, gebogen, st./st., 18cm, TC TÖNIS-ADSON vascular scissors, curved, bl./bl., 18cm, TC



**ZA-004-547**



**ZA-001-738 /  
ZA-001-740**



**ZA-001-739 /  
ZA-001-741**



**ZA-001-750**  
bis / to  
**ZA-001-752**

<b>Bestell-Nr. Ordering no.</b>	<b>Bezeichnung Description</b>
<b>ZA-001-738</b>	Strabismus Schere, gerade, st./st., 11.5cm <i>Strabismus scissors, straight, bl./bl., 11.5cm</i>
<b>ZA-001-740</b>	Strabismus Schere, gebogen, st./st., 11.5cm <i>Strabismus scissors, curved, bl./bl., 11.5cm</i>
<b>ZA-001-739</b>	Strabismus Schere, gerade, st./st., 11.5cm, TC <i>Strabismus scissors, straight, bl./bl., 11.5cm, TC</i>
<b>ZA-001-741</b>	Strabismus Schere, gebogen, st./st., 11.5cm, TC <i>Strabismus scissors, curved, bl./bl., 11.5cm, TC</i>
<b>ZA-001-750</b>	SPENCER Ligaturschere, 9cm <i>SPENCER ligature scissors, 9cm</i>
<b>ZA-001-751</b>	SPENCER Ligaturschere, 10.5cm <i>SPENCER ligature scissors, 10.5cm</i>
<b>ZA-001-752</b>	SPENCER Ligaturschere, 12cm <i>SPENCER ligature scissors, 12cm</i>
<b>ZA-004-547</b>	LITTLER Ligaturschere, gebogen, 14cm <i>LITTLER ligature scissors, curved, 14cm</i>



**ZA-001-707**



**ZA-004-548**

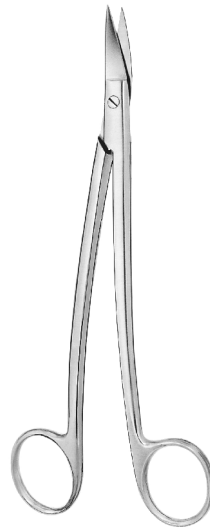

**ZA-001-800**

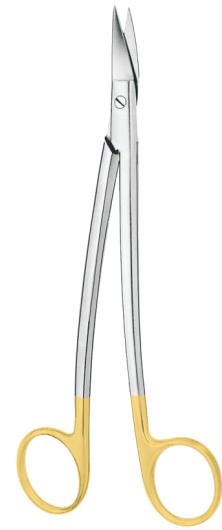

**ZA-004-549**

<b>Bestell-Nr.</b> <b>Ordering no.</b>	<b>Bezeichnung</b> <b>Description</b>
<b>ZA-004-548</b>	PRINCE Nasenschere, gebogen, 17.5cm <i>PRINCE nasal scissors, curved, 17.5cm</i>
<b>ZA-001-707</b>	BÖTTCHER Tonsillenschere, gebogen, 18cm <i>BÖTTCHER tonsil scissors, curved, 18cm</i>
<b>ZA-001-800</b>	DEAN Tonsillenschere, gezahnt, 17cm, TC <i>DEAN tonsil scissors, serrated, 17cm, TC</i>
<b>ZA-004-549</b>	DEAN Tonsillenschere, abgwinkelt, 17cm <i>DEAN tonsil scissors, angled, 17cm</i>





**ZA-001-730**  
bis / to  
**ZA-001-736**



**ZA-004-536**  
bis / to  
**ZA-001-541**



**ZA-001-733 /**  
**ZA-001-737**

<b>Bestell-Nr.</b> <b>Ordering no.</b>	<b>Bezeichnung</b> <b>Description</b>
<b>ZA-001-730</b>	IRIS Schere, gerade, sp./sp., 9cm <i>IRIS scissors, straight, sh./sh., 9cm</i>
<b>ZA-001-731</b>	IRIS Schere, gerade, sp./sp., 10.5cm <i>IRIS scissors, straight, sh./sh., 10.5cm</i>
<b>ZA-001-732</b>	IRIS Schere, gerade, sp./sp., 11.5cm <i>IRIS scissors, straight, sh./sh., 11.5cm</i>
<b>ZA-001-734</b>	IRIS Schere, gebogen, sp./sp., 9cm <i>IRIS scissors, curved, sh./sh., 9cm</i>
<b>ZA-001-735</b>	IRIS Schere, gebogen, sp./sp., 10.5cm <i>IRIS scissors, curved, sh./sh., 10.5cm</i>
<b>ZA-001-736</b>	IRIS Schere, gebogen, sp./sp., 11.5cm <i>IRIS scissors, curved, sh./sh., 11.5cm</i>
<b>ZA-001-733</b>	IRIS Schere gerade, sp./sp., 11.5cm, TC <i>IRIS scissors, straight, sh./sh., 11.5cm, TC</i>
<b>ZA-001-737</b>	IRIS Schere gebogen, sp./sp., 11.5cm, TC <i>IRIS scissors, curved, sh./sh., 11.5cm, TC</i>
<b>ZA-004-540</b>	IRIS Schere, fein, gerade, sp./sp., 9.5cm <i>IRIS scissors, fine, straight, sh./sh., 9.5cm</i>
<b>ZA-004-536</b>	IRIS Schere, fein, gerade, sp./sp., 10.5cm <i>IRIS scissors, fine, straight, sh./sh., 10.5cm</i>
<b>ZA-004-537</b>	IRIS Schere, fein, gerade, sp./sp., 11.5cm <i>IRIS scissors, fine, straight, sh./sh., 11.5cm</i>
<b>ZA-004-541</b>	IRIS Schere, fein, gebogen, sp./sp., 9cm <i>IRIS scissors, fine, curved, sh./sh., 9cm</i>
<b>ZA-004-538</b>	IRIS Schere, fein, gebogen, sp./sp., 10.5cm <i>IRIS scissors, fine, curved, sh./sh., 10.5cm</i>
<b>ZA-004-539</b>	IRIS Schere, fein, gebogen, sp./sp., 11.5cm <i>IRIS scissors, fine, curved, sh./sh., 11.5cm</i>



**ZA-004-490**  
bis / to  
**ZA-004-495**



**ZA-004-414**  
bis / to  
**ZA-004-417**

<b>Bestell-Nr.</b> <b>Ordering no.</b>	<b>Bezeichnung</b> <b>Description</b>
<b>ZA-004-414</b>	IRIS Mikro-Schere, gerade, sp./sp., 10mm Blatt, 12cm <i>IRIS micro scissors, straight, sh./sh., 10mm blade, 12cm</i>
<b>ZA-004-415</b>	IRIS Mikro-Schere, gebogen, sp./sp., 10mm Blatt, 12cm <i>IRIS micro scissors, curved, sh./sh., 10mm blade, 12cm</i>
<b>ZA-004-416</b>	VANNAS Mikro-Schere, gerade, sp./sp., 10mm Blatt, 8cm <i>VANNAS micro scissors, straight, sh./sh., 10mm blade, 8cm</i>
<b>ZA-004-417</b>	VANNAS Mikro-Schere, gebogen, sp./sp., 10mm Blatt, 8cm <i>VANNAS micro scissors, curved, sh./sh., 10mm blade, 8cm</i>
<b>ZA-004-490</b>	Mikro-Federschere, glatt, spitz, gerade, ohne Sperre, 14.5cm <i>Micro scissors, smooth, sharp, straight, without ratchet, 14.5cm</i>
<b>ZA-004-491</b>	Mikro-Federschere, glatt, spitz, gebogen, ohne Sperre, 14.5cm <i>Micro scissors, smooth, sharp, curved, without ratchet, 14.5cm</i>
<b>ZA-004-492</b>	Mikro-Federschere, breiter Griff, glatt, spitz, gerade, ohne Sperre, 14.5cm <i>Micro scissors, wide flat handle, smooth, sharp, straight, without ratchet, 14.5cm</i>
<b>ZA-004-493</b>	Mikro-Federschere, breiter Griff, glatt, spitz, gebogen, ohne Sperre, 14.5cm <i>Micro scissors, wide flat handle, smooth, sharp, curved, without ratchet, 14.5cm</i>
<b>ZA-004-494</b>	Mikro-Federschere, breiter Griff, VANNAS Schneide, glatt, spitz, gerade, ohne Sperre, 14.5cm <i>Micro scissors, wide flat handle, VANNAS blade, smooth, sharp, straight, without ratchet, 14.5cm</i>
<b>ZA-004-495</b>	Mikro-Federschere, breiter Griff, VANNAS Schneide, glatt, spitz, gebogen, ohne Sperre, 14.5cm <i>Micro scissors, wide flat handle, VANNAS blade, smooth, sharp, curved, without ratchet, 14.5cm</i>



**ZA-004-496 /  
ZA-001-497**



**ZA-004-498 /  
ZA-001-499**



**ZA-001-500**



**ZA-004-501  
bis / to  
ZA-001-506**



**ZA-004-507  
bis / to  
ZA-001-512**

<b>Bestell-Nr. Ordering no.</b>	<b>Bezeichnung Description</b>
<b>ZA-004-496</b>	JACOBSEN Federschere, bajonett, glatt, spitz, gerade, ohne Sperre, 18cm <i>JACOBSEN scissors, bayonet, smooth, sharp, straight, without ratchet, 18cm</i>
<b>ZA-004-497</b>	JACOBSEN Federschere, bajonett, glatt, spitz, gebogen, ohne Sperre, 18cm <i>JACOBSEN scissors, bayonet, smooth, sharp, curved, without ratchet, 18cm</i>
<b>ZA-004-498</b>	JACOBSEN Federschere, bajonett, VANNAS Schneide, glatt, spitz, gerade, ohne Sperre, 18cm <i>JACOBSEN scissors, bayonet, VANNAS blade, smooth, sharp, straight, without ratchet, 18cm</i>
<b>ZA-004-499</b>	JACOBSEN Federschere, bajonett, VANNAS Schneide, glatt, spitz, gebogen, ohne Sperre, 18cm <i>JACOBSEN scissors, bayonet, VANNAS blade, smooth, sharp, curved, without ratchet, 18cm</i>
<b>ZA-004-500</b>	JACOBSEN Federschere, bajonett, VANNAS Schneide, glatt, spitz, 45° gewinkelt, ohne Sperre, 18cm <i>JACOBSEN scissors, bayonet, VANNAS blade, smooth, sharp, 45° angled, without ratchet, 18cm</i>
<b>ZA-004-501</b>	YASARGIL Mikro-Federschere, bajonett, glatt, spitz, gerade, ohne Sperre, 18cm <i>YASARGIL micro scissors, bayonet, smooth, sharp, straight, without ratchet, 18cm</i>
<b>ZA-004-503</b>	YASARGIL Mikro-Federschere, bajonett, glatt, spitz, gerade, ohne Sperre, 20cm <i>YASARGIL micro scissors, bayonet, smooth, sharp, straight, without ratchet, 20cm</i>
<b>ZA-004-505</b>	YASARGIL Mikro-Federschere, bajonett, glatt, spitz, gerade, ohne Sperre, 22.5cm <i>YASARGIL micro scissors, bayonet, smooth, sharp, straight, without ratchet, 22.5cm</i>
<b>ZA-004-502</b>	YASARGIL Mikro-Federschere, bajonett, glatt, spitz, gebogen, ohne Sperre, 18cm <i>YASARGIL micro scissors, bayonet, smooth, sharp, curved, without ratchet, 18cm</i>
<b>ZA-004-504</b>	YASARGIL Mikro-Federschere, bajonett, glatt, spitz, gebogen, ohne Sperre, 20cm <i>YASARGIL micro scissors, bayonet, smooth, sharp, curved, without ratchet, 20cm</i>
<b>ZA-004-506</b>	YASARGIL Mikro-Federschere, bajonett, glatt, spitz, gebogen, ohne Sperre, 22.5cm <i>YASARGIL micro scissors, bayonet, smooth, sharp, curved, without ratchet, 22.5cm</i>
<b>ZA-004-507</b>	YASARGIL Mikro-Federschere, bajonett, VANNAS Schneide, glatt, spitz, gerade, ohne Sperre, 18cm <i>YASARGIL micro scissors, bayonet, VANNAS blade, smooth, sharp, straight, without ratchet, 18cm</i>
<b>ZA-004-509</b>	YASARGIL Mikro-Federschere, bajonett, VANNAS Schneide, glatt, spitz, gerade, ohne Sperre, 20cm <i>YASARGIL micro scissors, bayonet, VANNAS blade, smooth, sharp, straight, without ratchet, 20cm</i>
<b>ZA-004-511</b>	YASARGIL Mikro-Federschere, bajonett, VANNAS Schneide, glatt, spitz, gerade, ohne Sperre, 22.5cm <i>YASARGIL micro scissors, bayonet, VANNAS blade, smooth, sharp, straight, without ratchet, 22.5cm</i>
<b>ZA-004-508</b>	YASARGIL Mikro-Federschere, bajonett, VANNAS Schneide, glatt, spitz, gebogen, ohne Sperre, 18cm <i>YASARGIL micro scissors, bayonet, VANNAS blade, smooth, sharp, curved, without ratchet, 18cm</i>
<b>ZA-004-510</b>	YASARGIL Mikro-Federschere, bajonett, VANNAS Schneide, glatt, spitz, gebogen, ohne Sperre, 20cm <i>YASARGIL micro scissors, bayonet, VANNAS blade, smooth, sharp, curved, without ratchet, 20cm</i>
<b>ZA-004-512</b>	YASARGIL Mikro-Federschere, bajonett, VANNAS Schneide, glatt, spitz, gebogen, ohne Sperre, 22.5cm <i>YASARGIL micro scissors, bayonet, VANNAS blade, smooth, sharp, curved, without ratchet, 22.5cm</i>



**ZA-004-659**  
bis / to  
**ZA-004-662**



**ZA-004-655**  
bis / to  
**ZA-004-658**



**ZA-004-649**  
bis / to  
**ZA-004-654**



**ZA-004-649**  
bis / to  
**ZA-004-662**

Bestell-Nr. Ordering no.	Bezeichnung Description
<b>ZA-004-649</b>	YASARGIL Mikro-Federschere, bajonett, glatt, spitz, gerade, ohne Sperre, 16cm YASARGIL micro scissors, bayonett, smooth, sharp, straight, without ratchet, 16cm
<b>ZA-004-650</b>	YASARGIL Mikro-Federschere, bajonett, glatt, spitz, gerade, ohne Sperre, 18cm YASARGIL micro scissors, bayonett, smooth, sharp, straight, without ratchet, 18cm
<b>ZA-004-692</b>	YASARGIL Mikro-Federschere, bajonett, glatt, spitz, gerade, ohne Sperre, 22.5cm YASARGIL micro scissors, bayonett, smooth, sharp, straight, without ratchet, 22.5cm
<b>ZA-004-651</b>	YASARGIL Mikro-Federschere, bajonett, glatt, spitz, gebogen, ohne Sperre, 16cm YASARGIL micro scissors, bayonett, smooth, sharp, curved, without ratchet, 16cm
<b>ZA-004-652</b>	YASARGIL Mikro-Federschere, bajonett, glatt, spitz, gebogen, ohne Sperre, 18cm YASARGIL micro scissors, bayonett, smooth, sharp, curved, without ratchet, 18cm
<b>ZA-004-653</b>	YASARGIL Mikro-Federschere, bajonett, glatt, spitz, gebogen, ohne Sperre, 20cm YASARGIL micro scissors, bayonett, smooth, sharp, curved, without ratchet, 20cm
<b>ZA-004-654</b>	YASARGIL Mikro-Federschere, bajonett, glatt, spitz, gebogen, ohne Sperre, 22.5cm YASARGIL micro scissors, bayonett, smooth, sharp, curved, without ratchet, 22.5cm
<b>ZA-004-655</b>	YASARGIL Mikro-Federschere mit Knopf, bajonett, glatt, spitz, gebogen, ohne Sperre, 16cm YASARGIL micro scissors with probe pointed blade, bayonett, smooth, sharp, curved, without ratchet, 16cm
<b>ZA-004-656</b>	YASARGIL Mikro-Federschere mit Knopf, bajonett, glatt, spitz, gebogen, ohne Sperre, 18cm YASARGIL micro scissors with probe pointed blade, bayonett, smooth, sharp, curved, without ratchet, 18cm
<b>ZA-004-657</b>	YASARGIL Mikro-Federschere mit Knopf, bajonett, glatt, spitz, gebogen, ohne Sperre, 20cm YASARGIL micro scissors with probe pointed blade, bayonett, smooth, sharp, curved, without ratchet, 20cm
<b>ZA-004-658</b>	YASARGIL Mikro-Federschere mit Knopf, bajonett, glatt, spitz, gebogen, ohne Sperre, 22.5cm YASARGIL micro scissors with probe pointed blade, bayonett, smooth, sharp, curved, without ratchet, 22.5cm
<b>ZA-004-659</b>	YASARGIL Mikro-Federschere, bajonett, glatt, spitz, 125° gebogen, ohne Sperre, 16cm YASARGIL micro scissors, bayonett, smooth, sharp, 125° curved, without ratchet, 16cm
<b>ZA-004-660</b>	YASARGIL Mikro-Federschere, bajonett, glatt, spitz, 125° gebogen, ohne Sperre, 18cm YASARGIL micro scissors, bayonett, smooth, sharp, 125° curved, without ratchet, 18cm
<b>ZA-004-661</b>	YASARGIL Mikro-Federschere, bajonett, glatt, spitz, 125° gebogen, ohne Sperre, 20cm YASARGIL micro scissors, bayonett, smooth, sharp, 125° curved, without ratchet, 20cm
<b>ZA-004-662</b>	YASARGIL Mikro-Federschere, bajonett, glatt, spitz, 125° gebogen, ohne Sperre, 22.5cm YASARGIL micro scissors, bayonett, smooth, sharp, 125° curved, without ratchet, 22.5cm



Bestell-Nr. Ordering no.	Bezeichnung Description
<b>ZA-004-664</b>	YASARGIL Präparier-Mikro-Federschere, bajonett, glatt, gerade, ohne Sperre, 16.5cm YASARGIL dissecting micro scissors, bayonett, smooth, straight, without ratchet, 16.5cm
<b>ZA-004-665</b>	YASARGIL Präparier-Mikro-Federschere, bajonett, glatt, gerade, ohne Sperre, 18cm YASARGIL dissecting micro scissors, bayonett, smooth, straight, without ratchet, 18cm
<b>ZA-004-666</b>	YASARGIL Präparier-Mikro-Federschere, bajonett, glatt, gerade, ohne Sperre, 20cm YASARGIL dissecting micro scissors, bayonett, smooth, straight, without ratchet, 20cm
<b>ZA-004-667</b>	YASARGIL Präparier-Mikro-Federschere, bajonett, glatt, gerade, ohne Sperre, 22.5cm YASARGIL dissecting micro scissors, bayonett, smooth, straight, without ratchet, 22.5cm
<b>ZA-004-668</b>	YASARGIL Präparier-Mikro-Federschere, bajonett, glatt, gebogen, ohne Sperre, 16.5cm YASARGIL dissecting micro scissors, bayonett, smooth, curved, without ratchet, 16.5cm
<b>ZA-004-669</b>	IRIS Schere, gebogen, sp./sp., 11.5cm IRIS scissors, curved, sh./sh., 11.5cm
<b>ZA-004-670</b>	IRIS Schere gerade, sp./sp., 11.5cm, TC IRIS scissors, straight, sh./sh., 11.5cm, TC
<b>ZA-004-671</b>	IRIS Schere gebogen, sp./sp., 11.5cm, TC IRIS scissors, curved, sh./sh., 11.5cm, TC

**ZA-001-400**

**ZA-001-294**  
 bis / to  
**ZA-001-302**

**ZA-001-385 /**  
**ZA-004-010**

**ZA-001-523**

**ZA-001-387 /**  
**ZA-004-011**

**ZA-001-401**  
 bis / to  
**ZA-001-404**

**ZA-003-997**

Bestell-Nr. Ordering no.	Bezeichnung Description
<b>ZA-001-294</b>	Standard anatomische Pinzette, gerade, 10.5cm <i>Standard dressing forceps, straight, 10.5cm</i>
<b>ZA-001-295</b>	Standard anatomische Pinzette, gerade, 11.5cm <i>Standard dressing forceps, straight, 11.5cm</i>
<b>ZA-001-296</b>	Standard anatomische Pinzette, gerade, 13cm <i>Standard dressing forceps, straight, 13cm</i>
<b>ZA-001-297</b>	Standard anatomische Pinzette, gerade, 14.5cm <i>Standard dressing forceps, straight, 14.5cm</i>
<b>ZA-001-298</b>	Standard anatomische Pinzette, gerade, 16cm <i>Standard dressing forceps, straight, 16cm</i>
<b>ZA-001-299</b>	Standard anatomische Pinzette, gerade, 18cm <i>Standard dressing forceps, straight, 18cm</i>
<b>ZA-001-300</b>	Standard anatomische Pinzette, gerade, 20cm <i>Standard dressing forceps, straight, 20cm</i>
<b>ZA-001-301</b>	Standard anatomische Pinzette, gerade, 25cm <i>Standard dressing forceps, straight, 25cm</i>
<b>ZA-001-302</b>	Standard anatomische Pinzette, gerade, 30cm <i>Standard dressing forceps, straight, 30cm</i>
<b>ZA-001-385</b>	ADSON anatomische Pinzette, fein, 12cm <i>ADSON dressing forceps, fine, 12cm</i>
<b>ZA-001-523</b>	ADSON anatomische Pinzette, fein, 12cm, TC <i>ADSON dressing forceps, fine, 12cm, TC</i>
<b>ZA-004-010</b>	ADSON anatomische Pinzette, 12cm <i>ADSON dressing forceps, 12cm</i>
<b>ZA-001-387</b>	MIKRO-ADSON anatomische Pinzette, 12cm <i>MICRO-ADSON dressing forceps, 12cm</i>
<b>ZA-004-011</b>	MIKRO-ADSON anatomische Pinzette, sehr fein, 12cm <i>MICRO-ADSON dressing forceps, very fine, 12cm</i>
<b>ZA-001-400</b>	MCINDOE anatomische Pinzette, gerade, 15cm <i>MCINDOE dressing forceps, straight, 15cm</i>
<b>ZA-001-401</b>	SEMKEN anatomische Pinzette, schlank, gerade, 12.5cm <i>SEMKEN dressing forceps, delicate, straight, 12.5cm</i>
<b>ZA-001-402</b>	SEMKEN anatomische Pinzette, schlank, gerade, 15cm <i>SEMKEN dressing forceps, delicate, straight, 15cm</i>
<b>ZA-001-403</b>	SEMKEN anatomische Pinzette, schlank, gebogen, 12.5cm <i>SEMKEN dressing forceps, delicate, curved, 12.5cm</i>
<b>ZA-001-404</b>	SEMKEN anatomische Pinzette, schlank, gebogen, 15cm <i>SEMKEN dressing forceps, delicate, curved, 15cm</i>
<b>ZA-003-997</b>	Anatomische Pinzette, Standardmodell, gerade, 11.5cm <i>Dressing forceps, standard model, straight, 11.5cm</i>



ZA-001-442



ZA-004-006



ZA-001-303  
bis / to  
ZA-001-311



ZA-001-389 /  
ZA-004-013



ZA-001-391



ZA-001-405  
bis / to  
ZA-001-408



ZA-001-524

Bestell-Nr. Ordering no.	Bezeichnung Description
ZA-001-303	Standard chirurgische Pinzette, gerade, 1x2 Zähne, 10.5cm Standard dissecting forceps, straight, 1x2 teeth, 10.5cm
ZA-001-304	Standard chirurgische Pinzette, gerade, 1x2 Zähne, 11.5cm Standard dissecting forceps, straight, 1x2 teeth, 11.5cm
ZA-001-305	Standard chirurgische Pinzette, gerade, 1x2 Zähne, 13cm Standard dissecting forceps, straight, 1x2 teeth, 13cm
ZA-001-306	Standard chirurgische Pinzette, gerade, 1x2 Zähne, 14.5cm Standard dissecting forceps, straight, 1x2 teeth, 14.5cm
ZA-001-307	Standard chirurgische Pinzette, gerade, 1x2 Zähne, 16cm Standard dissecting forceps, straight, 1x2 teeth, 16cm
ZA-001-308	Standard chirurgische Pinzette, gerade, 1x2 Zähne, 18cm Standard dissecting forceps, straight, 1x2 teeth, 18cm
ZA-001-309	Standard chirurgische Pinzette, gerade, 1x2 Zähne, 20cm Standard dissecting forceps, straight, 1x2 teeth, 20cm
ZA-001-310	Standard chirurgische Pinzette, gerade, 1x2 Zähne, gerade, 25cm Standard dissecting forceps, straight, 1x2 teeth, 25cm
ZA-001-311	Standard chirurgische Pinzette, gerade, 1x2 Zähne, 30cm Standard dissecting forceps, straight, 1x2 teeth, 30cm
ZA-001-389	ADSON chirurgische Pinzette, 1x2 Zähne, 12cm ADSON dissecting forceps, 1x2 teeth, 12cm
ZA-004-013	ADSON chirurgische Pinzette, sehr fein, 1x2 Zähne, 12cm ADSON dissecting forceps, very fine, 1x2 teeth, 12cm
ZA-001-524	ADSON chirurgische Pinzette, 1x2 Zähne, 12cm, TC ADSON dissecting forceps, 1x2 teeth, 12cm, TC
ZA-001-391	MIKRO-ADSON chirurgische Pinzette, 1x2 Zähne, 12cm MICRO-ADSON dissecting forceps, 1x2 teeth, 12cm
ZA-001-405	SEMKEN chirurgische Pinzette, gerade, 1x2 Zähne, 12.5cm SEMKEN dissecting forceps, straight, 1x2 teeth, 12.5cm
ZA-001-406	SEMKEN chirurgische Pinzette, gerade, 1x2 Zähne, 15cm SEMKEN dissecting forceps, straight, 1x2 teeth, 15cm
ZA-001-407	SEMKEN chirurgische Pinzette, gebogen, 1x2 Zähne, 12.5cm SEMKEN dissecting forceps, curved, 1x2 teeth, 12.5cm
ZA-001-408	SEMKEN chirurgische Pinzette, gebogen, 1x2 Zähne, 15cm SEMKEN dissecting forceps, curved, 1x2 teeth, 15cm
ZA-001-442	GILLIES chirurgische Pinzette, 1x2 Zähne, 15cm GILLIES dissecting forceps, 1x2 teeth, 15cm
ZA-004-006	Chirurgische Pinzette, Standardmodell, 1x2 Zähne, gerade, 14.5cm Dissecting forceps, standard model, 1x2 teeth, straight, 14.5cm





**ZA-001-503**



**ZA-004-316**



**ZA-001-457 /  
ZA-001-462**



**ZA-004-381**



**ZA-001-492 /  
ZA-001-493**



**ZA-001-495 /  
ZA-001-497**

<b>Bestell-Nr. Ordering no.</b>	<b>Bezeichnung Description</b>
<b>ZA-001-457</b>	Uhrmacher-Pinzette, spitz, gerade, 11cm <i>Jeweler type forceps, pointed, straight, 11cm</i>
<b>ZA-001-462</b>	Uhrmacher-Pinzette, spitz, gebogen, 11cm <i>Jeweler type forceps, pointed, curved, 11cm</i>
<b>ZA-001-492</b>	GRAEFFE Irispinzette, anatomisch, gerade, 0.7mm, 10cm <i>GRAEFFE iris dressing forceps, straight, 0.7mm, 10cm</i>
<b>ZA-001-493</b>	GRAEFFE Irispinzette, anatomisch, gebogen, 0.7mm, 10cm <i>GRAEFFE iris dressing forceps, curved, 0.7mm, 10cm</i>
<b>ZA-001-495</b>	GRAEFFE Irispinzette, 1x2 Zähne, gerade, 0.7mm, 10cm <i>GRAEFFE iris dissecting forceps, 1x2 teeth, straight, 0.7mm, 10cm</i>
<b>ZA-001-497</b>	GRAEFFE Irispinzette, 1x2 Zähne, gebogen, 0.7mm, 10cm <i>GRAEFFE iris dissecting forceps, 1x2 teeth, curved, 0.7mm, 10cm</i>
<b>ZA-001-503</b>	DEBAKEY atraumatische Pinzette, 1.5mm breit, 16cm <i>DEBAKEY atrauma forceps, 1.5mm wide, 16cm</i>
<b>ZA-004-316</b>	ADSON-BROWN atraumatische Pinzette, 1.5mm breit, 12cm <i>ADSON-BROWN atrauma forceps, 1.5mm wide, 12cm</i>
<b>ZA-001-381</b>	COTTLE Columellapinzette, 10.5cm <i>COTTLE columella forceps, 10.5cm</i>



**ZA-001-487 /  
ZA-001-491**



**ZA-001-486 /  
ZA-004-364 /  
ZA-004-365 /  
ZA-004-552**



**ZA-001-488**

<b>Bestell-Nr. Ordering no.</b>	<b>Bezeichnung Description</b>
<b>ZA-001-486</b>	TROELTSCH Ohrpinzette, anatomisch, fein, 12cm <i>TROELTSCH ear dressing forceps, delicate, 12cm</i>
<b>ZA-001-487</b>	LUCAE Ohrpinzette, anatomisch, bajonettförmig, 14cm <i>LUCAE ear dressing forceps, bayonett shape, 14cm</i>
<b>ZA-001-488</b>	JANSEN Ohrpinzette, anatomisch, bajonettförmig, 16cm <i>JANSEN ear dressing forceps, bayonett shape, 16cm</i>
<b>ZA-001-491</b>	GRUENWALD (JANSEN) Nasenpinzette, anatomisch, bajonettförmig, 20cm <i>GRUENWALD (JANSEN) nasal dressing forceps, bayonett shape, 20cm</i>
<b>ZA-004-364</b>	TROELTSCH Nasenpinzette, kniegebogen, anatomisch, 15cm <i>TROELTSCH nasal dressing forceps, angular, 15cm</i>
<b>ZA-004-365</b>	TROELTSCH Nasenpinzette, kniegebogen, anatomisch, 17cm <i>TROELTSCH nasal dressing forceps, angular, 17cm</i>
<b>ZA-004-552</b>	TROELTSCH Nasenpinzette, kniegebogen, 1x2 Zähne, 13cm <i>TROELTSCH nasal forceps, angular, 1x2 teeth, 13cm</i>



**ZA-004-691**



**ZA-004-680**  
 bis / to  
**ZA-004-690**



**ZA-004-272**



**ZA-004-014**



**ZA-004-327**



**ZA-004-382**



**ZA-004-383**

<b>Bestell-Nr.</b> <b>Ordering no.</b>	<b>Bezeichnung</b> <b>Description</b>
<b>ZA-004-014</b>	ADSON-BROWN Pinzette, 7x7 Zähne, 12cm ADSON-BROWN forceps, 7x7 teeth, 12cm
<b>ZA-004-272</b>	COTTLE Pinzette, bajonettförmig, Fixierschraube, vorn gerieft, innen mit Zähnen, 15cm COTTLE forceps, bayonett shaped, fixation screw, front serrated, inside toothed, 15cm
<b>ZA-004-327</b>	DERLACKI Gehörknöchel Pinzette, 12cm DERLACKI ossicle forceps, 12cm
<b>ZA-004-382</b>	GRAEFFE Fixierpinzette, 7x8 Zähne, 11cm GRAEFFE fixation forceps, 7x8 teeth, 11cm
<b>ZA-004-383</b>	CASTROVIEJO Fadenpinzette, 1x2 Zähne, sehr fein, 0.12mm, 10.5cm CASTROVIEJO suture forceps, 1x2 teeth, very delicate, 0.12mm, 10.5cm
<b>ZA-004-680</b>	YASARGIL Mikropinzette, bajonettförmig, Spitze 0.6mm, 16cm YASARGIL micro forceps, bayonett shape, tip 0.6mm, 16cm
<b>ZA-004-681</b>	YASARGIL Mikropinzette, bajonettförmig, Spitze 0.6mm, 18cm YASARGIL micro forceps, bayonett shape, tip 0.6mm, 18cm
<b>ZA-004-682</b>	YASARGIL Mikropinzette, bajonettförmig, Spitze 0.6mm, 20cm YASARGIL micro forceps, bayonett shape, tip 0.6mm, 20cm
<b>ZA-004-683</b>	YASARGIL Mikropinzette, bajonettförmig, Spitze 0.6mm, 22cm YASARGIL micro forceps, bayonett shape, tip 0.6mm, 22cm
<b>ZA-004-684</b>	YASARGIL Mikropinzette, bajonettförmig, Spitze 0.6mm, 24cm YASARGIL micro forceps, bayonett shape, tip 0.6mm, 24cm
<b>ZA-004-685</b>	YASARGIL Mikropinzette, bajonettförmig, Spitze 0.9mm, 16cm YASARGIL micro forceps, bayonett shape, tip 0.9mm, 16cm
<b>ZA-004-686</b>	YASARGIL Mikropinzette, bajonettförmig, Spitze 0.9mm, 18cm YASARGIL micro forceps, bayonett shape, tip 0.9mm, 18cm
<b>ZA-004-687</b>	YASARGIL Mikropinzette, bajonettförmig, Spitze 0.9mm, 20cm YASARGIL micro forceps, bayonett shape, tip 0.9mm, 20cm
<b>ZA-004-688</b>	YASARGIL Mikropinzette, bajonettförmig, Spitze 0.9mm, 22cm YASARGIL micro forceps, bayonett shape, tip 0.9mm, 22cm
<b>ZA-004-689</b>	YASARGIL Mikropinzette, bajonettförmig, Spitze 0.9mm, 24cm YASARGIL micro forceps, bayonett shape, tip 0.9mm, 24cm
<b>ZA-004-690</b>	YASARGIL Mikropinzette, bajonettförmig, 1x2 Zähne, 18cm YASARGIL micro forceps, bayonett shape, 1x2 teeth, 18cm
<b>ZA-004-691</b>	YASARGIL Mikropinzette, bajonettförmig, spitz, 22.5cm YASARGIL micro forceps, bayonett shape, sharp, 22.5cm



**ZA-001-061**  
bis / to  
**ZA-001-064**



**ZA-001-069**  
bis / to  
**ZA-001-074**



**ZA-001-039**  
bis / to  
**ZA-001-045**

Bestell-Nr. Ordering no.	Bezeichnung Description
<b>ZA-001-039</b>	HALSTED-MOSQUITO Arterienklemme, gerade, 12.5cm <i>HALSTED-MOSQUITO haemostatic forceps, straight, 12.5cm</i>
<b>ZA-001-041</b>	HALSTED-MOSQUITO Arterienklemme, gebogen, 12.5cm <i>HALSTED-MOSQUITO haemostatic forceps, curved, 12.5cm</i>
<b>ZA-001-043</b>	HALSTED-MOSQUITO Arterienklemme, gerade, 1x2 Zähne, 12.5cm <i>HALSTED-MOSQUITO haemostatic forceps, straight, 1x2 teeth, 12.5cm</i>
<b>ZA-001-045</b>	HALSTED-MOSQUITO Arterienklemme, gebogen, 1x2 Zähne, 12.5cm <i>HALSTED-MOSQUITO haemostatic forceps, curved, 1x2 teeth, 12.5cm</i>
<b>ZA-001-061</b>	KELLY Arterienklemme, gerade, 14cm <i>KELLY haemostatic forceps, straight, 14cm</i>
<b>ZA-001-062</b>	KELLY Arterienklemme, gebogen, 14cm <i>KELLY haemostatic forceps, curved, 14cm</i>
<b>ZA-001-063</b>	KELLY-RANKIN Arterienklemme, gerade, 16cm <i>KELLY-RANKIN haemostatic forceps, straight, 16cm</i>
<b>ZA-001-064</b>	KELLY-RANKIN Arterienklemme, gebogen, 16cm <i>KELLY-RANKIN haemostatic forceps, curved, 16cm</i>
<b>ZA-001-069</b>	CRILE Arterienklemme, gerade, 14cm <i>CRILE haemostatic forceps, straight, 14cm</i>
<b>ZA-001-070</b>	CRILE Arterienklemme, gebogen, 14cm <i>CRILE haemostatic forceps, curved, 14cm</i>
<b>ZA-001-073</b>	CRILE-RANKIN Arterienklemme, gerade, 16cm <i>CRILE-RANKIN haemostatic forceps, straight, 16cm</i>
<b>ZA-001-074</b>	CRILE-RANKIN Arterienklemme, gebogen, 16cm <i>CRILE-RANKIN haemostatic forceps, curved, 16cm</i>



**ZA-001-075**  
bis / to  
**ZA-001-090**

<b>Bestell-Nr.</b> <b>Ordering no.</b>	<b>Bezeichnung</b> <b>Description</b>
<b>ZA-001-075</b>	ROCHESTER-PEAN Arterienklemme, gerade, 14cm <i>ROCHESTER-PEAN haemostatic forceps, straight, 14cm</i>
<b>ZA-001-076</b>	ROCHESTER-PEAN Arterienklemme, gerade, 16cm <i>ROCHESTER-PEAN haemostatic forceps, straight, 16cm</i>
<b>ZA-001-077</b>	ROCHESTER-PEAN Arterienklemme, gerade, 18cm <i>ROCHESTER-PEAN haemostatic forceps, straight, 18cm</i>
<b>ZA-001-078</b>	ROCHESTER-PEAN Arterienklemme, gerade, 20cm <i>ROCHESTER-PEAN haemostatic forceps, straight, 20cm</i>
<b>ZA-001-079</b>	ROCHESTER-PEAN Arterienklemme, gerade, 22cm <i>ROCHESTER-PEAN haemostatic forceps, straight, 22cm</i>
<b>ZA-001-080</b>	ROCHESTER-PEAN Arterienklemme, gerade, 24cm <i>ROCHESTER-PEAN haemostatic forceps, straight, 24cm</i>
<b>ZA-001-081</b>	ROCHESTER-PEAN Arterienklemme, gerade, 26cm <i>ROCHESTER-PEAN haemostatic forceps, straight, 26cm</i>
<b>ZA-001-082</b>	ROCHESTER-PEAN Arterienklemme, gerade, 30cm <i>ROCHESTER-PEAN haemostatic forceps, straight, 30cm</i>
<b>ZA-001-083</b>	ROCHESTER-PEAN Arterienklemme, gebogen, 14cm <i>ROCHESTER-PEAN haemostatic forceps, curved, 14cm</i>
<b>ZA-001-084</b>	ROCHESTER-PEAN Arterienklemme, gebogen, 16cm <i>ROCHESTER-PEAN haemostatic forceps, curved, 16cm</i>
<b>ZA-001-085</b>	ROCHESTER-PEAN Arterienklemme, gebogen, 18cm <i>ROCHESTER-PEAN haemostatic forceps, curved, 18cm</i>
<b>ZA-001-086</b>	ROCHESTER-PEAN Arterienklemme, gebogen, 20cm <i>ROCHESTER-PEAN haemostatic forceps, curved, 20cm</i>
<b>ZA-001-087</b>	ROCHESTER-PEAN Arterienklemme, gebogen, 22cm <i>ROCHESTER-PEAN haemostatic forceps, curved, 22cm</i>
<b>ZA-001-088</b>	ROCHESTER-PEAN Arterienklemme, gebogen, 24cm <i>ROCHESTER-PEAN haemostatic forceps, curved, 24cm</i>
<b>ZA-001-089</b>	ROCHESTER-PEAN Arterienklemme, gebogen, 26cm <i>ROCHESTER-PEAN haemostatic forceps, curved, 26cm</i>
<b>ZA-001-090</b>	ROCHESTER-PEAN Arterienklemme, gebogen, 30cm <i>ROCHESTER-PEAN haemostatic forceps, curved, 30cm</i>



**ZA-001-091**  
bis / to  
**ZA-001-106**

<b>Bestell-Nr. Ordering no.</b>	<b>Bezeichnung Description</b>
<b>ZA-001-091</b>	OCHSNER-KOCHER Arterienklemme, gerade, 1x2 Zähne, 14cm OCHSNER-KOCHER haemostatic forceps, straight, 1x2 teeth, 14cm
<b>ZA-001-092</b>	OCHSNER-KOCHER Arterienklemme, gerade, 1x2 Zähne, 16cm OCHSNER-KOCHER haemostatic forceps, straight, 1x2 teeth, 16cm
<b>ZA-001-093</b>	OCHSNER-KOCHER Arterienklemme, gerade, 1x2 Zähne, 18cm OCHSNER-KOCHER haemostatic forceps, straight, 1x2 teeth, 18cm
<b>ZA-001-094</b>	OCHSNER-KOCHER Arterienklemme, gerade, 1x2 Zähne, 20cm OCHSNER-KOCHER haemostatic forceps, straight, 1x2 teeth, 20cm
<b>ZA-001-095</b>	OCHSNER-KOCHER Arterienklemme, gerade, 1x2 Zähne, 22cm OCHSNER-KOCHER haemostatic forceps, straight, 1x2 teeth, 22cm
<b>ZA-001-096</b>	OCHSNER-KOCHER Arterienklemme, gerade, 1x2 Zähne, 24cm OCHSNER-KOCHER haemostatic forceps, straight, 1x2 teeth, 24cm
<b>ZA-001-097</b>	OCHSNER-KOCHER Arterienklemme, gerade, 1x2 Zähne, 26cm OCHSNER-KOCHER haemostatic forceps, straight, 1x2 teeth, 26cm
<b>ZA-001-098</b>	OCHSNER-KOCHER Arterienklemme, gerade, 1x2 Zähne, 30cm OCHSNER-KOCHER haemostatic forceps, straight, 1x2 teeth, 30cm
<b>ZA-001-099</b>	OCHSNER-KOCHER Arterienklemme, gebogen, 1x2 Zähne, 14cm OCHSNER-KOCHER haemostatic forceps, curved, 1x2 teeth, 14cm
<b>ZA-001-100</b>	OCHSNER-KOCHER Arterienklemme, gebogen, 1x2 Zähne, 16cm OCHSNER-KOCHER haemostatic forceps, curved, 1x2 teeth, 16cm
<b>ZA-001-101</b>	OCHSNER-KOCHER Arterienklemme, gebogen, 1x2 Zähne, 18cm OCHSNER-KOCHER haemostatic forceps, curved, 1x2 teeth, 18cm
<b>ZA-001-102</b>	OCHSNER-KOCHER Arterienklemme, gebogen, 1x2 Zähne, 20cm OCHSNER-KOCHER haemostatic forceps, curved, 1x2 teeth, 20cm
<b>ZA-001-103</b>	OCHSNER-KOCHER Arterienklemme, gebogen, 1x2 Zähne, 22cm OCHSNER-KOCHER haemostatic forceps, curved, 1x2 teeth, 22cm
<b>ZA-001-104</b>	OCHSNER-KOCHER Arterienklemme, gebogen, 1x2 Zähne, 24cm OCHSNER-KOCHER haemostatic forceps, curved, 1x2 teeth, 24cm
<b>ZA-001-105</b>	OCHSNER-KOCHER Arterienklemme, gebogen, 1x2 Zähne, 26cm OCHSNER-KOCHER haemostatic forceps, curved, 1x2 teeth, 26cm
<b>ZA-001-106</b>	OCHSNER-KOCHER Arterienklemme, gebogen, 1x2 Zähne, 30cm OCHSNER-KOCHER haemostatic forceps, curved, 1x2 teeth, 30cm

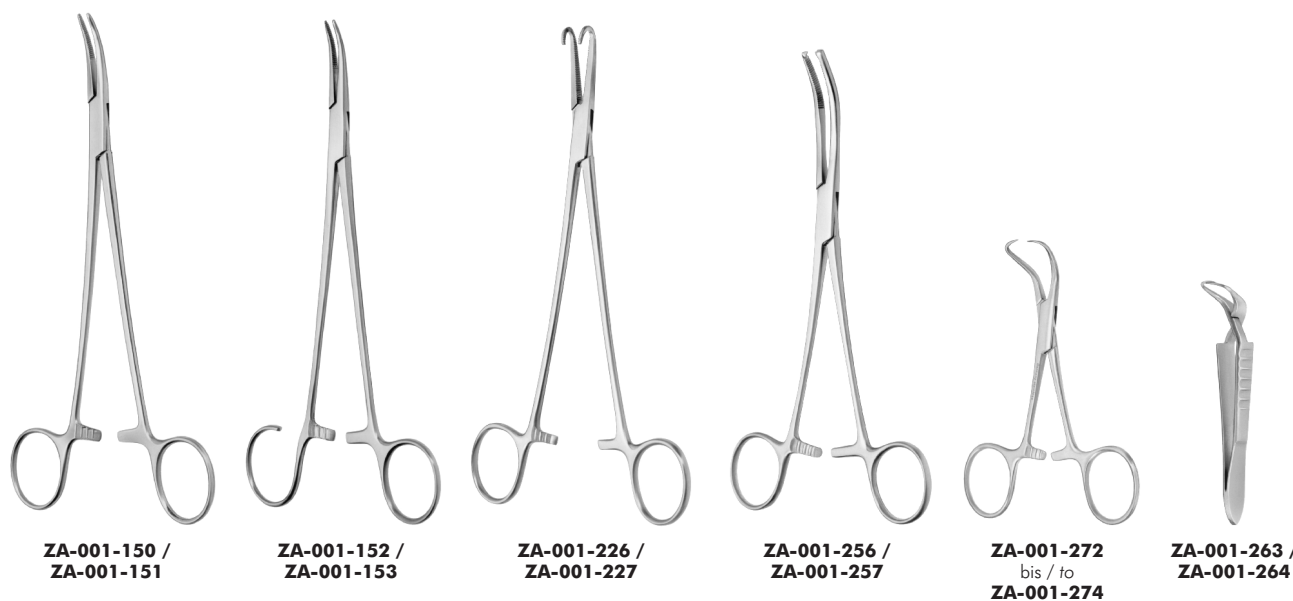

Bestell-Nr. Ordering no.	Bezeichnung Description
<b>ZA-001-150</b>	SCHNIDT Tonsillenklemme, leicht gebogen, 19cm <i>SCHNIDT tonsil forceps, slightly curved, 19cm</i>
<b>ZA-001-151</b>	SCHNIDT Tonsillenklemme, stark gebogen, 19cm <i>SCHNIDT tonsil forceps, strong curved, 19cm</i>
<b>ZA-001-152</b>	SCHNIDT-SAWTELL Tonsillenklemme, leicht gebogen, 19cm <i>SCHNIDT-SAWTELL tonsil forceps, slightly curved, 19cm</i>
<b>ZA-001-153</b>	SCHNIDT-SAWTELL Tonsillenklemme, stark gebogen, 19cm <i>SCHNIDT-SAWTELL tonsil forceps, strong curved, 19cm</i>
<b>ZA-001-226</b>	NEGUS Gallenklemme, Fig. 1, 19cm <i>NEGUS gall duct clamp, fig. 1, 19cm</i>
<b>ZA-001-227</b>	NEGUS Gallenklemme, Fig. 2, 19cm <i>NEGUS gall duct clamp, fig. 2, 19cm</i>
<b>ZA-001-256</b>	MIKULICZ Peritoneumklemme, 1x2 Zähne, 18cm <i>MIKULICZ peritoneum forceps, 1x2 teeth, 18cm</i>
<b>ZA-001-257</b>	MIKULICZ Peritoneumklemme, 1x2 Zähne, 20cm <i>MIKULICZ peritoneum forceps, 1x2 teeth, 20cm</i>
<b>ZA-001-263</b>	JONES Tuchklemme, 5cm <i>JONES towel forceps, 5cm</i>
<b>ZA-001-264</b>	JONES Tuchklemme, 9cm <i>JONES towel forceps, 9cm</i>
<b>ZA-001-272</b>	BACKHAUS Tuchklemme, 8cm <i>BACKHAUS towel forceps, 8cm</i>
<b>ZA-001-273</b>	BACKHAUS Tuchklemme, 11cm <i>BACKHAUS towel forceps, 11cm</i>
<b>ZA-001-274</b>	BACKHAUS Tuchklemme, 13cm <i>BACKHAUS towel forceps, 13cm</i>



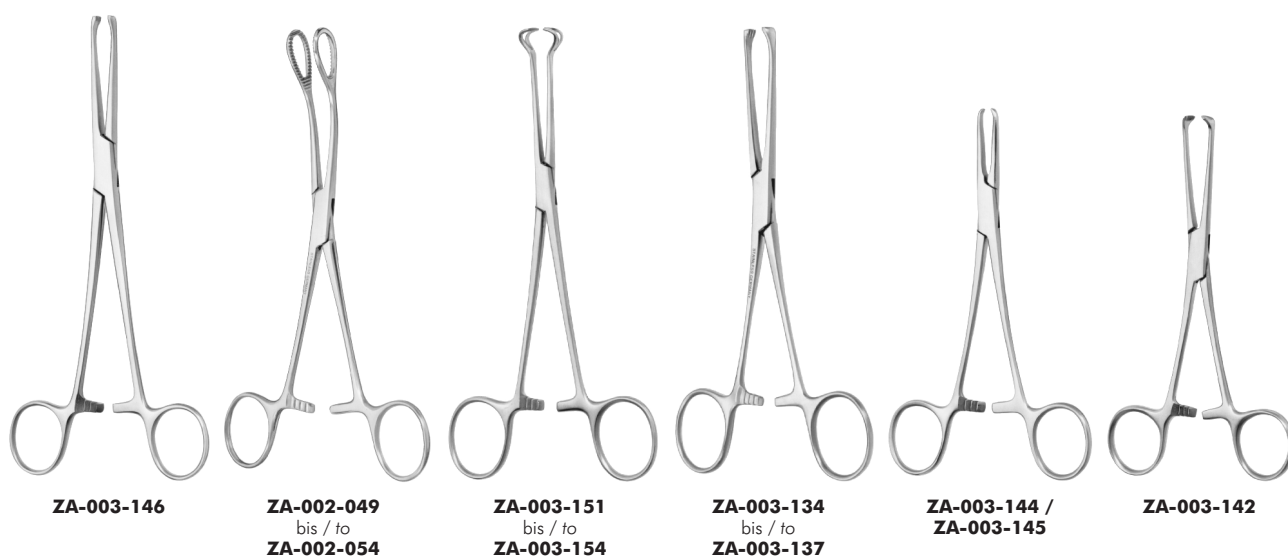

Bestell-Nr. Ordering no.	Bezeichnung Description
<b>ZA-002-049</b>	FOERSTER-BALLENGER Schwammzange, gerade, 18cm <i>FOERSTER-BALLENGER sponge forceps, straight, 18cm</i>
<b>ZA-002-051</b>	FOERSTER-BALLENGER Schwammzange, gerade, 25cm <i>FOERSTER-BALLENGER sponge forceps, straight, 25cm</i>
<b>ZA-002-052</b>	FOERSTER-BALLENGER Schwammzange, gebogen, 18cm <i>FOERSTER-BALLENGER sponge forceps, curved, 18cm</i>
<b>ZA-002-054</b>	FOERSTER-BALLENGER Schwammzange, gebogen, 25cm <i>FOERSTER-BALLENGER sponge forceps, curved, 25cm</i>
<b>ZA-003-134</b>	ALLIS Gewebefasszange, 4x5 Zähne, 15cm <i>ALLIS tissue forceps, 4x5 teeth, 15cm</i>
<b>ZA-003-135</b>	ALLIS Gewebefasszange, 5x6 Zähne, 15cm <i>ALLIS tissue forceps, 5x6 teeth, 15cm</i>
<b>ZA-003-136</b>	ALLIS Gewebefasszange, 5x6 Zähne, 19cm <i>ALLIS tissue forceps, 5x6 teeth, 19cm</i>
<b>ZA-003-137</b>	ALLIS Gewebefasszange, 5x6 Zähne, 25cm <i>ALLIS tissue forceps, 5x6 teeth, 25cm</i>
<b>ZA-003-142</b>	ALLIS-ALDAIR Gewebefasszange, 10x11 Zähne, 15cm <i>ALLIS-ALDAIR tissue forceps, 10x11 teeth, 15cm</i>
<b>ZA-003-144</b>	JUDD-ALLIS Gewebefasszange, 3x4 Zähne, 15cm <i>JUDD-ALLIS tissue forceps, 3x4 teeth, 15cm</i>
<b>ZA-003-145</b>	JUDD-ALLIS Gewebefasszange, 3x4 Zähne, 19cm <i>JUDD-ALLIS tissue forceps, 3x4 teeth, 19cm</i>
<b>ZA-003-146</b>	THOMS-ALLIS Gewebefasszange, 6x7 Zähne, 20cm <i>THOMS-ALLIS tissue forceps, 6x7 teeth, 20cm</i>
<b>ZA-003-151</b>	BABCOCK Gewebefasszange, 16cm <i>BABCOCK tissue forceps, 16cm</i>
<b>ZA-003-152</b>	BABCOCK Gewebefasszange, 18cm <i>BABCOCK tissue forceps, 18cm</i>
<b>ZA-003-153</b>	BABCOCK Gewebefasszange, 20cm <i>BABCOCK tissue forceps, 20cm</i>
<b>ZA-003-154</b>	BABCOCK Gewebefasszange, 24cm <i>BABCOCK tissue forceps, 24cm</i>



**ZA-002-081**  
bis / to  
**ZA-002-092**



**ZA-002-121**  
bis / to  
**ZA-002-126**

<b>Bestell-Nr. Ordering no.</b>	<b>Bezeichnung Description</b>
<b>ZA-002-081</b>	Wundhaken, einzahnig, scharf, 16cm <i>Retractor, 1 prong, sharp, 16cm</i>
<b>ZA-002-082</b>	Wundhaken, zweizahnig, scharf, 16cm <i>Retractor, 2 prongs, sharp, 16cm</i>
<b>ZA-002-083</b>	Wundhaken, dreizahnig, scharf, 16cm <i>Retractor, 3 prongs, sharp, 16cm</i>
<b>ZA-002-084</b>	Wundhaken, vierzahnig, scharf, 16cm <i>Retractor, 4 prongs, sharp, 16cm</i>
<b>ZA-002-085</b>	Wundhaken, einzahnig, halbscharf, 16cm <i>Retractor, 1 prong, semi-sharp, 16cm</i>
<b>ZA-002-086</b>	Wundhaken, zweizahnig, halbscharf, 16cm <i>Retractor, 2 prongs, semi-sharp, 16cm</i>
<b>ZA-002-087</b>	Wundhaken, dreizahnig, halbscharf, 16cm <i>Retractor, 3 prongs, semi-sharp, 16cm</i>
<b>ZA-002-088</b>	Wundhaken, vierzahnig, halbscharf, 16cm <i>Retractor, 4 prongs, semi-sharp, 16cm</i>
<b>ZA-002-089</b>	Wundhaken, einzahnig, stumpf, 16cm <i>Retractor, 1 prong, blunt, 16cm</i>
<b>ZA-002-090</b>	Wundhaken, zweizahnig, stumpf, 16cm <i>Retractor, 2 prongs, blunt, 16cm</i>
<b>ZA-002-091</b>	Wundhaken, dreizahnig, stumpf, 16cm <i>Retractor, 3 prongs, blunt, 16cm</i>
<b>ZA-002-092</b>	Wundhaken, vierzahnig, stumpf, 16cm <i>Retractor, 4 prongs, blunt, 16cm</i>
<b>ZA-002-121</b>	DESMARRES Wundhaken, 8mm, 13cm <i>DESMARRES retractor, 8mm, 13cm</i>
<b>ZA-002-122</b>	DESMARRES Wundhaken, 10mm, 13cm <i>DESMARRES retractor, 10mm, 13cm</i>
<b>ZA-002-123</b>	DESMARRES Wundhaken, 12mm, 13cm <i>DESMARRES retractor, 12mm, 13cm</i>
<b>ZA-002-124</b>	DESMARRES Wundhaken, 14mm, 13cm <i>DESMARRES retractor, 14mm, 13cm</i>
<b>ZA-002-125</b>	DESMARRES Wundhaken, 16mm, 13cm <i>DESMARRES retractor, 16mm, 13cm</i>
<b>ZA-002-126</b>	DESMARRES Wundhaken, 18mm, 13cm <i>DESMARRES retractor, 18mm, 13cm</i>



**ZA-002-181**  
bis / to  
**ZA-002-185**



**ZA-002-186**  
bis / to  
**ZA-002-190**



**ZA-002-299**  
bis / to  
**ZA-002-301**



**ZA-002-117**  
bis / to  
**ZA-002-120**

Bestell-Nr. Ordering no.	Bezeichnung Description
<b>ZA-002-117</b>	MINI-LANGENBECK Wundhaken, 10x6mm, 16cm MINI-LANGENBECK retractor, 10x6mm, 16cm
<b>ZA-002-118</b>	MINI-LANGENBECK Wundhaken, 20x6mm, 16cm MINI-LANGENBECK retractor, 20x6mm, 16cm
<b>ZA-002-119</b>	MINI-LANGENBECK Wundhaken, 17x5mm, 16cm MINI-LANGENBECK retractor, 17x5mm, 16cm
<b>ZA-002-120</b>	MINI-LANGENBECK Wundhaken, 22x8mm, 16cm MINI-LANGENBECK retractor, 22x8mm, 16cm
<b>ZA-002-181</b>	LANGENBECK Wundhaken, 30x11mm, 22cm LANGENBECK retractor, 30x11mm, 22cm
<b>ZA-002-182</b>	LANGENBECK Wundhaken, 30x14mm, 22cm LANGENBECK retractor, 30x14mm, 22cm
<b>ZA-002-183</b>	LANGENBECK Wundhaken, 30x16mm, 22cm LANGENBECK retractor, 30x16mm, 22cm
<b>ZA-002-184</b>	LANGENBECK Wundhaken, 40x11mm, 22cm LANGENBECK retractor, 40x11mm, 22cm
<b>ZA-002-185</b>	LANGENBECK Wundhaken, 50x11mm, 22cm LANGENBECK retractor, 50x11mm, 22cm
<b>ZA-002-186</b>	LANGENBECK Wundhaken, 30x11mm, 22cm LANGENBECK retractor, 30x11mm, 22cm
<b>ZA-002-187</b>	LANGENBECK Wundhaken, 30x11mm, 22cm LANGENBECK retractor, 30x11mm, 22cm
<b>ZA-002-188</b>	LANGENBECK Wundhaken, 30x11mm, 22cm LANGENBECK retractor, 30x11mm, 22cm
<b>ZA-002-189</b>	LANGENBECK Wundhaken, 30x11mm, 22cm LANGENBECK retractor, 30x11mm, 22cm
<b>ZA-002-190</b>	LANGENBECK Wundhaken, 30x11mm, 22cm LANGENBECK retractor, 30x11mm, 22cm
<b>ZA-002-299</b>	PARKER-LANGENBECK US-ARMY Wundhaken, Set Fig. 1+2 PARKER-LANGENBECK US-ARMY retractor, set fig. 1+2
<b>ZA-002-300</b>	PARKER-LANGENBECK US-ARMY Wundhaken, Fig. 1 PARKER-LANGENBECK US-ARMY retractor, fig. 1
<b>ZA-002-301</b>	PARKER-LANGENBECK US-ARMY Wundhaken, Fig. 2 PARKER-LANGENBECK US-ARMY retractor, fig. 2



**ZA-004-623**



**ZA-002-191**  
bis / to  
**ZA-002-199**



**ZA-004-620**  
bis / to  
**ZA-004-622**



**ZA-004-626**  
bis / to  
**ZA-004-629**

<b>Bestell-Nr. Ordering no.</b>	<b>Bezeichnung Description</b>
<b>ZA-002-191</b>	KOCHER-LANGENBECK Wundhaken, 25x6mm, 21cm KOCHER-LANGENBECK retractor, 25x6mm, 21cm
<b>ZA-002-192</b>	KOCHER-LANGENBECK Wundhaken, 25x8mm, 21cm KOCHER-LANGENBECK retractor, 25x8mm, 21cm
<b>ZA-002-193</b>	KOCHER-LANGENBECK Wundhaken, 35x11mm, 21cm KOCHER-LANGENBECK retractor, 35x11mm, 21cm
<b>ZA-002-194</b>	KOCHER-LANGENBECK Wundhaken, 35x15mm, 21cm KOCHER-LANGENBECK retractor, 35x15mm, 21cm
<b>ZA-002-195</b>	KOCHER-LANGENBECK Wundhaken, 40x11mm, 21cm KOCHER-LANGENBECK retractor, 40x11mm, 21cm
<b>ZA-002-196</b>	KOCHER-LANGENBECK Wundhaken, 55x11mm, 21cm KOCHER-LANGENBECK retractor, 55x11mm, 21cm
<b>ZA-002-197</b>	KOCHER-LANGENBECK Wundhaken, 70x14mm, 21cm KOCHER-LANGENBECK retractor, 70x14mm, 21cm
<b>ZA-002-198</b>	KOCHER-LANGENBECK Wundhaken, 80x12mm, 21cm KOCHER-LANGENBECK retractor, 80x12mm, 21cm
<b>ZA-002-199</b>	KOCHER-LANGENBECK Wundhaken, 80x16mm, 21cm KOCHER-LANGENBECK retractor, 80x16mm, 21cm
<b>ZA-004-620</b>	LANGENBECK Wundhaken, 55x20mm, 21cm LANGENBECK retractor, 55x20mm, 21cm
<b>ZA-004-621</b>	LANGENBECK Wundhaken, 60x20mm, 21cm LANGENBECK retractor, 60x20mm, 21cm
<b>ZA-004-622</b>	LANGENBECK Wundhaken, 63x20mm, 21cm LANGENBECK retractor, 63x20mm, 21cm
<b>ZA-004-623</b>	LANGENBECK Wundhaken, 85x15mm, 21.5cm LANGENBECK retractor, 85x15mm, 21.5cm
<b>ZA-004-626</b>	LANGENBECK Wundhaken, 33x14mm, 21cm LANGENBECK retractor, 33x14mm, 21cm
<b>ZA-004-627</b>	LANGENBECK Wundhaken, 42x13mm, 21cm LANGENBECK retractor, 42x13mm, 21cm
<b>ZA-004-628</b>	LANGENBECK Wundhaken, 33x14mm, 21cm LANGENBECK retractor, 33x14mm, 21cm
<b>ZA-004-629</b>	LANGENBECK Wundhaken, 42x13mm, 21cm LANGENBECK retractor, 42x13mm, 21cm



**ZA-002-177**  
bis / to  
**ZA-002-180**



**ZA-002-133**  
bis / to  
**ZA-002-138**



**ZA-002-141 /**  
**ZA-002-142**



**ZA-002-139 /**  
**ZA-002-140**



**ZA-002-143**

Bestell-Nr. Ordering no.	Bezeichnung Description
<b>ZA-002-133</b>	CUSHING Wundhaken, 8mm, 20cm <i>CUSHING retractor, 8mm, 20cm</i>
<b>ZA-002-134</b>	CUSHING Wundhaken, 10mm, 20cm <i>CUSHING retractor, 10mm, 20cm</i>
<b>ZA-002-135</b>	CUSHING Wundhaken, 12mm, 20cm <i>CUSHING retractor, 12mm, 20cm</i>
<b>ZA-002-136</b>	CUSHING Wundhaken, 14mm, 20cm <i>CUSHING retractor, 14mm, 20cm</i>
<b>ZA-002-137</b>	CUSHING Wundhaken, 18mm, 20cm <i>CUSHING retractor, 18mm, 20cm</i>
<b>ZA-002-138</b>	CUSHING Wundhaken, 20mm, 20cm <i>CUSHING retractor, 20mm, 20cm</i>
<b>ZA-002-139</b>	BABY-SENN-MILLER Wundhaken, scharf, 15cm <i>BABY-SENN-MILLER retractor, sharp, 15cm</i>
<b>ZA-002-140</b>	BABY-SENN-MILLER Wundhaken, stumpf, 15cm <i>BABY-SENN-MILLER retractor, blunt, 15cm</i>
<b>ZA-002-141</b>	SENN-MILLER Wundhaken, scharf, 16cm <i>SENN-MILLER retractor, sharp, 16cm</i>
<b>ZA-002-142</b>	SENN-MILLER Wundhaken, stumpf, 16cm <i>SENN-MILLER retractor, blunt, 16cm</i>
<b>ZA-002-143</b>	RAGNELL-DAVIS Wundhaken, 14cm <i>RAGNELL-DAVIS retractor, 14cm</i>
<b>ZA-002-177</b>	ISRAEL Wundhaken, vierzahnig, 40x40mm, 25cm <i>ISRAEL retractor, 4 prongs, 40x40mm, 25cm</i>
<b>ZA-002-178</b>	ISRAEL Wundhaken, vierzahnig, 45x50mm, 25cm <i>ISRAEL retractor, 4 prongs, 45x50mm, 25cm</i>
<b>ZA-002-179</b>	ISRAEL Wundhaken, vierzahnig, 50x50mm, 25cm <i>ISRAEL retractor, 4 prongs, 50x50mm, 25cm</i>
<b>ZA-002-180</b>	ISRAEL Wundhaken, vierzahnig, 70x70mm, 25cm <i>ISRAEL retractor, 4 prongs, 70x70mm, 25cm</i>



**ZA-002-144**  
bis / to  
**ZA-002-158**

<b>Bestell-Nr. Ordering no.</b>	<b>Bezeichnung Description</b>
<b>ZA-002-144</b>	VOLKMANN Wundhaken, einzahnig, scharf, 21.5cm VOLKMANN retractor, 1 prong, sharp, 21.5cm
<b>ZA-002-145</b>	VOLKMANN Wundhaken, zweizahnig, scharf, 21.5cm VOLKMANN retractor, 2 prongs, sharp, 21.5cm
<b>ZA-002-146</b>	VOLKMANN Wundhaken, dreizahnig, scharf, 21.5cm VOLKMANN retractor, 3 prongs, sharp, 21.5cm
<b>ZA-002-147</b>	VOLKMANN Wundhaken, vierzahnig, scharf, 21.5cm VOLKMANN retractor, 4 prongs, sharp, 21.5cm
<b>ZA-002-148</b>	VOLKMANN Wundhaken, sechszahnig, scharf, 21.5cm VOLKMANN retractor, 6 prongs, sharp, 21.5cm
<b>ZA-002-149</b>	VOLKMANN Wundhaken, einzahnig, halbscharf, 21.5cm VOLKMANN retractor, 1 prong, semi-sharp, 21.5cm
<b>ZA-002-150</b>	VOLKMANN Wundhaken, zweizahnig, halbscharf, 21.5cm VOLKMANN retractor, 2 prongs, semi-sharp, 21.5cm
<b>ZA-002-151</b>	VOLKMANN Wundhaken, dreizahnig, halbscharf, 21.5cm VOLKMANN retractor, 3 prongs, semi-sharp, 21.5cm
<b>ZA-002-152</b>	VOLKMANN Wundhaken, vierzahnig, halbscharf, 21.5cm VOLKMANN retractor, 4 prongs, semi-sharp, 21.5cm
<b>ZA-002-153</b>	VOLKMANN Wundhaken, sechszahnig, halbscharf, 21.5cm VOLKMANN retractor, 6 prongs, semi-sharp, 21.5cm
<b>ZA-002-154</b>	VOLKMANN Wundhaken, einzahnig, stumpf, 21.5cm VOLKMANN retractor, 1 prong, blunt, 21.5cm
<b>ZA-002-155</b>	VOLKMANN Wundhaken, zweizahnig, stumpf, 21.5cm VOLKMANN retractor, 2 prongs, blunt, 21.5cm
<b>ZA-002-156</b>	VOLKMANN Wundhaken, dreizahnig, stumpf, 21.5cm VOLKMANN retractor, 3 prongs, blunt, 21.5cm
<b>ZA-002-157</b>	VOLKMANN Wundhaken, vierzahnig, stumpf, 21.5cm VOLKMANN retractor, 4 prongs, blunt, 21.5cm
<b>ZA-002-158</b>	VOLKMANN Wundhaken, sechszahnig, stumpf, 21.5cm VOLKMANN retractor, 6 prongs, blunt, 21.5cm



**ZA-002-159**  
bis / to  
**ZA-002-176**

<b>Bestell-Nr. Ordering no.</b>	<b>Bezeichnung Description</b>
<b>ZA-002-159</b>	KOCHER Wundhaken, einzahnig, scharf, 22cm <i>KOCHER retractor, 1 prong, sharp, 22cm</i>
<b>ZA-002-160</b>	KOCHER Wundhaken, zweizahnig, scharf, 22cm <i>KOCHER retractor, 2 prongs, sharp, 22cm</i>
<b>ZA-002-161</b>	KOCHER Wundhaken, dreizahnig, scharf, 22cm <i>KOCHER retractor, 3 prongs, sharp, 22cm</i>
<b>ZA-002-162</b>	KOCHER Wundhaken, vierzahnig, scharf, 22cm <i>KOCHER retractor, 4 prongs, sharp, 22cm</i>
<b>ZA-002-163</b>	KOCHER Wundhaken, sechszahnig, scharf, 22cm <i>KOCHER retractor, 6 prongs, sharp, 22cm</i>
<b>ZA-002-164</b>	KOCHER Wundhaken, achtzahnig, scharf, 22cm <i>KOCHER retractor, 8 prongs, sharp, 22cm</i>
<b>ZA-002-165</b>	KOCHER Wundhaken, einzahnig, halbscharf, 22cm <i>KOCHER retractor, 1 prong, semi-sharp, 22cm</i>
<b>ZA-002-166</b>	KOCHER Wundhaken, zweizahnig, halbscharf, 22cm <i>KOCHER retractor, 2 prongs, semi-sharp, 22cm</i>
<b>ZA-002-167</b>	KOCHER Wundhaken, dreizahnig, halbscharf, 22cm <i>KOCHER retractor, 3 prongs, semi-sharp, 22cm</i>
<b>ZA-002-168</b>	KOCHER Wundhaken, vierzahnig, halbscharf, 22cm <i>KOCHER retractor, 4 prongs, semi-sharp, 22cm</i>
<b>ZA-002-169</b>	KOCHER Wundhaken, sechszahnig, halbscharf, 22cm <i>KOCHER retractor, 6 prongs, semi-sharp, 22cm</i>
<b>ZA-002-170</b>	KOCHER Wundhaken, achtzahnig, halbscharf, 22cm <i>KOCHER retractor, 8 prongs, semi-sharp, 22cm</i>
<b>ZA-002-171</b>	KOCHER Wundhaken, einzahnig, stumpf, 22cm <i>KOCHER retractor, 1 prong, blunt, 22cm</i>
<b>ZA-002-172</b>	KOCHER Wundhaken, zweizahnig, stumpf, 22cm <i>KOCHER retractor, 2 prongs, blunt, 22cm</i>
<b>ZA-002-173</b>	KOCHER Wundhaken, dreizahnig, stumpf, 22cm <i>KOCHER retractor, 3 prongs, blunt, 22cm</i>
<b>ZA-002-174</b>	KOCHER Wundhaken, vierzahnig, stumpf, 22cm <i>KOCHER retractor, 4 prongs, blunt, 22cm</i>
<b>ZA-002-175</b>	KOCHER Wundhaken, sechszahnig, stumpf, 22cm <i>KOCHER retractor, 6 prongs, blunt, 22cm</i>
<b>ZA-002-176</b>	KOCHER Wundhaken, achtzahnig, stumpf, 22cm <i>KOCHER retractor, 8 prongs, blunt, 22cm</i>





**ZA-002-216**  
bis / to  
**ZA-002-218**



**ZA-004-601 /**  
**ZA-004-602**

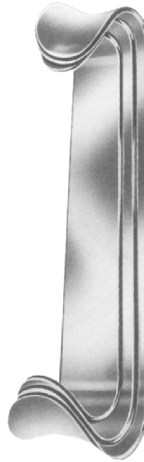

**ZA-002-280**  
bis / to  
**ZA-004-600**



**ZA-004-603**



**ZA-004-604**

<b>Bestell-Nr. Ordering no.</b>	<b>Bezeichnung Description</b>
<b>ZA-002-216</b>	MIDDELDORPF Wundhaken, 14x17mm, 21.5cm <i>MIDDELDORPF retractor, 14x17mm, 21.5cm</i>
<b>ZA-002-217</b>	MIDDELDORPF Wundhaken, 20x22mm, 22cm <i>MIDDELDORPF retractor, 20x22mm, 22cm</i>
<b>ZA-002-218</b>	MIDDELDORPF Wundhaken, 26x30mm, 23.5cm <i>MIDDELDORPF retractor, 26x30mm, 23.5cm</i>
<b>ZA-002-280</b>	ROUX Wundhaken, Set Fig. 1-3 <i>ROUX retractor, set fig. 1-3</i>
<b>ZA-002-281</b>	ROUX Wundhaken, Fig. 1 <i>ROUX retractor, fig. 1</i>
<b>ZA-002-282</b>	ROUX Wundhaken, Fig. 2 <i>ROUX retractor, fig. 2</i>
<b>ZA-002-283</b>	ROUX Wundhaken, Fig. 3 <i>ROUX retractor, fig. 3</i>
<b>ZA-004-596</b>	ROUX-MAGNUS Wundhaken, Set Fig. 1-3 <i>ROUX-MAGNUS retractor, set fig. 1-3</i>
<b>ZA-004-598</b>	ROUX-MAGNUS Wundhaken, Fig. 1 <i>ROUX-MAGNUS retractor, fig. 1</i>
<b>ZA-004-599</b>	ROUX-MAGNUS Wundhaken, Fig. 2 <i>ROUX-MAGNUS retractor, fig. 2</i>
<b>ZA-004-600</b>	ROUX-MAGNUS Wundhaken, Fig. 3 <i>ROUX-MAGNUS retractor, fig. 3</i>
<b>ZA-004-601</b>	ROUX Wundhaken, klein, 16.5cm <i>ROUX retractor, small, 16.5cm</i>
<b>ZA-004-602</b>	ROUX Wundhaken, gross, 18.5cm <i>ROUX retractor, large, 18.5cm</i>
<b>ZA-004-603</b>	MINI-ROUX Wundhaken, 15cm <i>MINI-ROUX retractor, 15cm</i>
<b>ZA-004-604</b>	BABY-ROUX Wundhaken, 13cm <i>BABY-ROUX retractor, 13cm</i>



**ZA-002-296**  
bis / to  
**ZA-002-298**



**ZA-002-293**  
bis / to  
**ZA-002-295**



**ZA-002-287**  
bis / to  
**ZA-002-289**

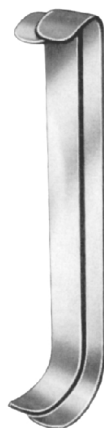

**ZA-004-605**



**ZA-002-290**  
bis / to  
**ZA-002-292**



**ZA-004-361**



**ZA-002-284**  
bis / to  
**ZA-002-286**

Bestell-Nr. Ordering no.	Bezeichnung Description
<b>ZA-002-284</b>	FARABEUF Wundhaken, Set Fig. 1+2, 12cm <i>FARABEUF retractor, set fig. 1+2, 12cm</i>
<b>ZA-002-285</b>	FARABEUF Wundhaken, Fig. 1, 12cm <i>FARABEUF retractor, fig. 1, 12cm</i>
<b>ZA-002-286</b>	FARABEUF Wundhaken, Fig. 2, 12cm <i>FARABEUF retractor, fig. 2, 12cm</i>
<b>ZA-002-287</b>	FARABEUF Wundhaken, Set Fig. 1+2, 15cm <i>FARABEUF retractor, set fig. 1+2, 15cm</i>
<b>ZA-002-288</b>	FARABEUF Wundhaken, Fig. 1, 15cm <i>FARABEUF retractor, fig. 1, 15cm</i>
<b>ZA-002-289</b>	FARABEUF Wundhaken, Fig. 2, 15cm <i>FARABEUF retractor, fig. 2, 15cm</i>
<b>ZA-002-290</b>	PARKER Wundhaken Set, klein, Fig. 1+2 <i>PARKER retractor, set, small, fig. 1+2</i>
<b>ZA-002-291</b>	PARKER Wundhaken, klein, Fig. 1 <i>PARKER retractor, small, fig. 1</i>
<b>ZA-002-292</b>	PARKER Wundhaken, klein, Fig. 2 <i>PARKER retractor, small, fig. 2</i>
<b>ZA-002-293</b>	PARKER Wundhaken Set, gross, Fig. 1+2 <i>PARKER retractor, set, large, fig. 1+2</i>
<b>ZA-002-294</b>	PARKER Wundhaken, gross, Fig. 1 <i>PARKER retractor, large, fig. 1</i>
<b>ZA-002-295</b>	PARKER Wundhaken, gross, Fig. 2 <i>PARKER retractor, large, fig. 2</i>
<b>ZA-002-296</b>	MATHIEU Wundhaken Set Fig. 1+2 <i>MATHIEU retractor set fig. 1+2</i>
<b>ZA-002-297</b>	MATHIEU Wundhaken Fig. 1 <i>MATHIEU retractor fig. 1</i>
<b>ZA-002-298</b>	MATHIEU Wundhaken Fig. 2 <i>MATHIEU retractor fig. 2</i>
<b>ZA-004-361</b>	WILLIGER Wundhaken, 4 scharfe Zähne, 13cm <i>WILLIGER retractor, 4 sharp prongs, 13cm</i>
<b>ZA-004-605</b>	COLLIN Wundhaken Set, 14.5cm <i>COLLIN retractor set, 14.5cm</i>



**ZA-004-613**  
bis / to  
**ZA-004-618**



**ZA-004-612**



**ZA-004-611**



**ZA-004-610**



**ZA-004-608 /  
ZA-004-609**



**ZA-004-606**



**ZA-004-607**

<b>Bestell-Nr. Ordering no.</b>	<b>Bezeichnung Description</b>
<b>ZA-004-606</b>	MAYO-COLLINS Wundhaken Set, 15cm <i>MAYO-COLLINS retractor set, 15cm</i>
<b>ZA-004-607</b>	RAGNELL Wundhaken, 15cm <i>RAGNELL retractor, 15cm</i>
<b>ZA-004-608</b>	MATHIEU Wundhaken, scharf, 16cm <i>MATHIEU retractor, sharp, 16cm</i>
<b>ZA-004-609</b>	MATHIEU Wundhaken, stumpf, 16cm <i>MATHIEU retractor, blunt, 16cm</i>
<b>ZA-004-610</b>	MEYERDING Wundhaken, 16cm <i>MEYERDING retractor, 16cm</i>
<b>ZA-004-611</b>	CUSHING Wundhaken, 20cm <i>CUSHING retractor, 20cm</i>
<b>ZA-004-612</b>	CUSHING Wundhaken, 21.5cm <i>CUSHING retractor, 21.5cm</i>
<b>ZA-004-613</b>	CUSHING Wundhaken, 8mm, 24cm <i>CUSHING retractor, 8mm, 24cm</i>
<b>ZA-004-614</b>	CUSHING Wundhaken, 10mm, 24cm <i>CUSHING retractor, 10mm, 24cm</i>
<b>ZA-004-615</b>	CUSHING Wundhaken, 12mm, 24cm <i>CUSHING retractor, 12mm, 24cm</i>
<b>ZA-004-616</b>	CUSHING Wundhaken, 14mm, 24cm <i>CUSHING retractor, 14mm, 24cm</i>
<b>ZA-004-617</b>	CUSHING Wundhaken, 16mm, 24cm <i>CUSHING retractor, 16mm, 24cm</i>
<b>ZA-004-618</b>	CUSHING Wundhaken, 18mm, 24cm <i>CUSHING retractor, 18mm, 24cm</i>

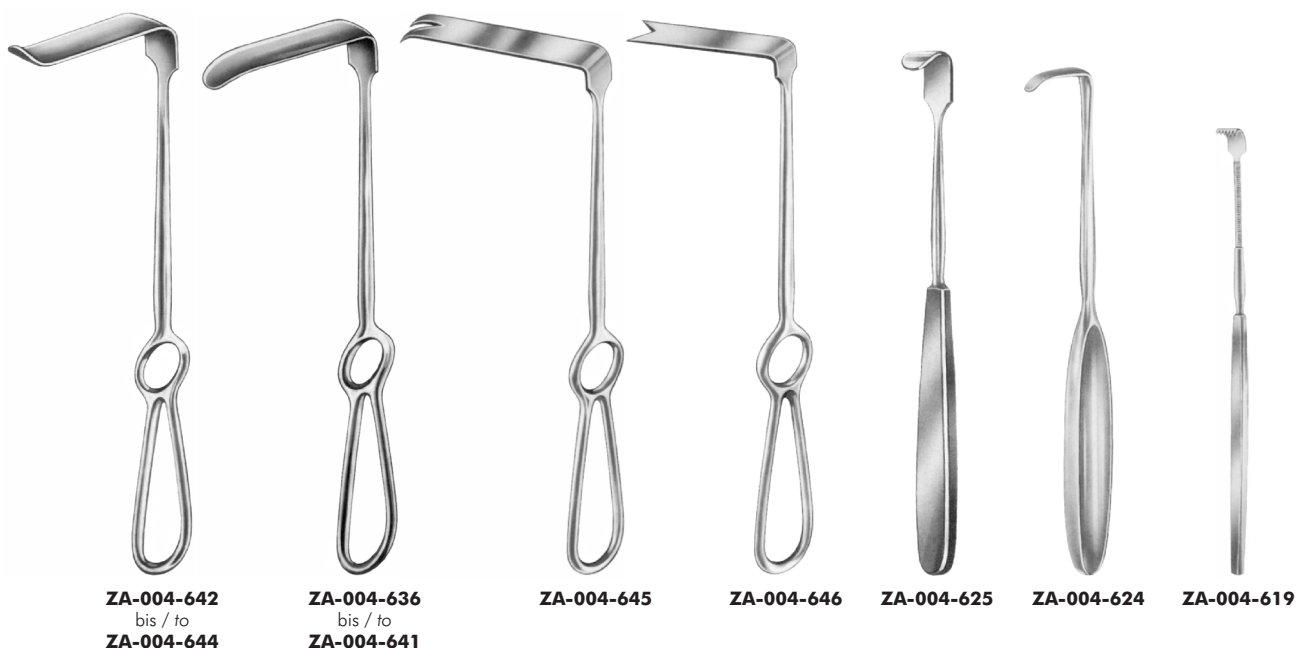

Bestell-Nr. Ordering no.	Bezeichnung Description
<b>ZA-004-619</b>	Wundhaken sechszahinig, 16cm <i>Retractor 6 prongs, 16cm</i>
<b>ZA-004-624</b>	LAHEY Wundhaken, 28x6mm, 19cm <i>LAHEY retractor, 28x6mm, 19cm</i>
<b>ZA-004-625</b>	LITTLE Wundhaken, 12x14mm, 20cm <i>LITTLE retractor, 12x14mm, 20cm</i>
<b>ZA-004-636</b>	OBWEGESER Wundhaken, 25x7mm, 22cm <i>OBWEGESER retractor, 25x7mm, 22cm</i>
<b>ZA-004-637</b>	OBWEGESER Wundhaken, 31x10mm, 22cm <i>OBWEGESER retractor, 31x10mm, 22cm</i>
<b>ZA-004-638</b>	OBWEGESER Wundhaken, 42x11mm, 22cm <i>OBWEGESER retractor, 42x11mm, 22cm</i>
<b>ZA-004-639</b>	OBWEGESER Wundhaken, 55x12mm, 22cm <i>OBWEGESER retractor, 55x12mm, 22cm</i>
<b>ZA-004-640</b>	OBWEGESER Wundhaken, 70x14mm, 22cm <i>OBWEGESER retractor, 70x14mm, 22cm</i>
<b>ZA-004-641</b>	OBWEGESER Wundhaken, 80x16mm, 22cm <i>OBWEGESER retractor, 80x16mm, 22cm</i>
<b>ZA-004-642</b>	OBWEGESER Wundhaken, 42x30mm, 22cm <i>OBWEGESER retractor, 42x30mm, 22cm</i>
<b>ZA-004-643</b>	OBWEGESER Wundhaken, 60x12mm, 22cm <i>OBWEGESER retractor, 60x12mm, 22cm</i>
<b>ZA-004-644</b>	OBWEGESER Wundhaken, 80x16mm, 22cm <i>OBWEGESER retractor, 80x16mm, 22cm</i>
<b>ZA-004-645</b>	RAMUS Wundhaken gezahnt, 70x11.5mm, 22cm <i>RAMUS retractor toothed, 70x11.5mm, 22cm</i>
<b>ZA-004-646</b>	SPINA NASALIS Wundhaken gezahnt, 44x9.5mm, 22cm <i>SPINA NASALIS retractor toothed, 44x9.5mm, 22cm</i>



**ZA-004-633 /  
ZA-004-633-1**



**ZA-004-631 /  
ZA-004-632**



**ZA-004-634 /  
ZA-004-635**



**ZA-003-415**



**ZA-004-648**



**ZA-004-647**

<b>Bestell-Nr. Ordering no.</b>	<b>Bezeichnung Description</b>
<b>ZA-003-415</b>	AUFRICHT Nasenhaken, 16cm <i>AUFRICHT nasal retractor, 16cm</i>
<b>ZA-004-631</b>	KIRSCH Wangenhaken, rechts, 60x10/68x10mm, 20cm <i>KIRSCH cheek retractor, right, 60x10/68x10mm, 20cm</i>
<b>ZA-004-632</b>	KIRSCH Wangenhaken, links, 60x10/68x10mm, 20cm <i>KIRSCH cheek retractor, left, 60x10/68x10mm, 20cm</i>
<b>ZA-004-633</b>	STEINHÄUSER Wangenhaken, rechts, 24.5cm <i>STEINHÄUSER cheek retractor, right, 24.5cm</i>
<b>ZA-004-633-1</b>	STEINHÄUSER Wangenhaken, links, 24.5cm <i>STEINHÄUSER cheek retractor, left, 24.5cm</i>
<b>ZA-004-634</b>	DOCKHORN Wangenhaken, 40x12mm, 20cm <i>DOCKHORN cheek retractor, 40x12mm, 20cm</i>
<b>ZA-004-635</b>	DOCKHORN Wangenhaken, 55x14mm, 20cm <i>DOCKHORN cheek retractor, 55x14mm, 20cm</i>
<b>ZA-004-647</b>	OBWEGESER Kinnhalter, 15.5cm <i>OBWEGESER retractor, 15.5cm</i>
<b>ZA-004-648</b>	OBWEGESER Kinnhalter, 16cm <i>OBWEGESER retractor, 16cm</i>



**ZA-004-557 /  
ZA-004-558**



**ZA-002-310**  
bis / to  
**ZA-002-317**



**ZA-002-319**  
bis / to  
**ZA-002-322 /  
ZA-004-331 /  
ZA-004-332**

Bestell-Nr. Ordering no.	Bezeichnung Description
<b>ZA-002-310</b>	WEITLANER Wundsperrer, 2x3 Zähne, scharf, 11cm WEITLANER retractor, 2x3 teeth, sharp, 11cm
<b>ZA-002-312</b>	WEITLANER Wundsperrer, 3x4 Zähne, scharf, 13cm WEITLANER retractor, 3x4 teeth, sharp, 13cm
<b>ZA-002-314</b>	WEITLANER Wundsperrer, 3x4 Zähne, scharf, 16cm WEITLANER retractor, 3x4 teeth, sharp, 16cm
<b>ZA-002-316</b>	WEITLANER Wundsperrer, 3x4 Zähne, scharf, 20cm WEITLANER retractor, 3x4 teeth, sharp, 20cm
<b>ZA-002-311</b>	WEITLANER Wundsperrer, 2x3 Zähne, stumpf, 11cm WEITLANER retractor, 2x3 teeth, blunt, 11cm
<b>ZA-002-313</b>	WEITLANER Wundsperrer, 3x4 Zähne, stumpf, 13cm WEITLANER retractor, 3x4 teeth, blunt, 13cm
<b>ZA-002-315</b>	WEITLANER Wundsperrer, 3x4 Zähne, stumpf, 16cm WEITLANER retractor, 3x4 teeth, blunt, 16cm
<b>ZA-002-317</b>	WEITLANER Wundsperrer, 3x4 Zähne, stumpf, 20cm WEITLANER retractor, 3x4 teeth, blunt, 20cm
<b>ZA-004-557</b>	WEITLANER Wundsperrer, 3x3 Zähne, scharf, 25cm WEITLANER retractor, 3x3 teeth, sharp, 25cm
<b>ZA-004-558</b>	WEITLANER Wundsperrer, 3x3 Zähne, stumpf, 25cm WEITLANER retractor, 3x3 teeth, blunt, 25cm
<b>ZA-002-319</b>	WULLSTEIN Wundsperrer, 3x3 Zähne, scharf, 11cm WULLSTEIN retractor, 3x3 teeth, sharp, 11cm
<b>ZA-002-320</b>	WULLSTEIN Wundsperrer, 3x3 Zähne, scharf, 13cm WULLSTEIN retractor, 3x3 teeth, sharp, 13cm
<b>ZA-004-331</b>	WULLSTEIN Wundsperrer, 3x3 Zähne, scharf, 16cm WULLSTEIN retractor, 3x3 teeth, sharp, 16cm
<b>ZA-002-321</b>	WULLSTEIN Wundsperrer, 3x3 Zähne, stumpf, 11cm WULLSTEIN retractor, 3x3 teeth, blunt, 11cm
<b>ZA-002-322</b>	WULLSTEIN Wundsperrer, 3x3 Zähne, stumpf, 13cm WULLSTEIN retractor, 3x3 teeth, blunt, 13cm
<b>ZA-004-332</b>	WULLSTEIN Wundsperrer, 3x3 Zähne, scharf, 16cm WULLSTEIN retractor, 3x3 teeth, sharp, 16cm

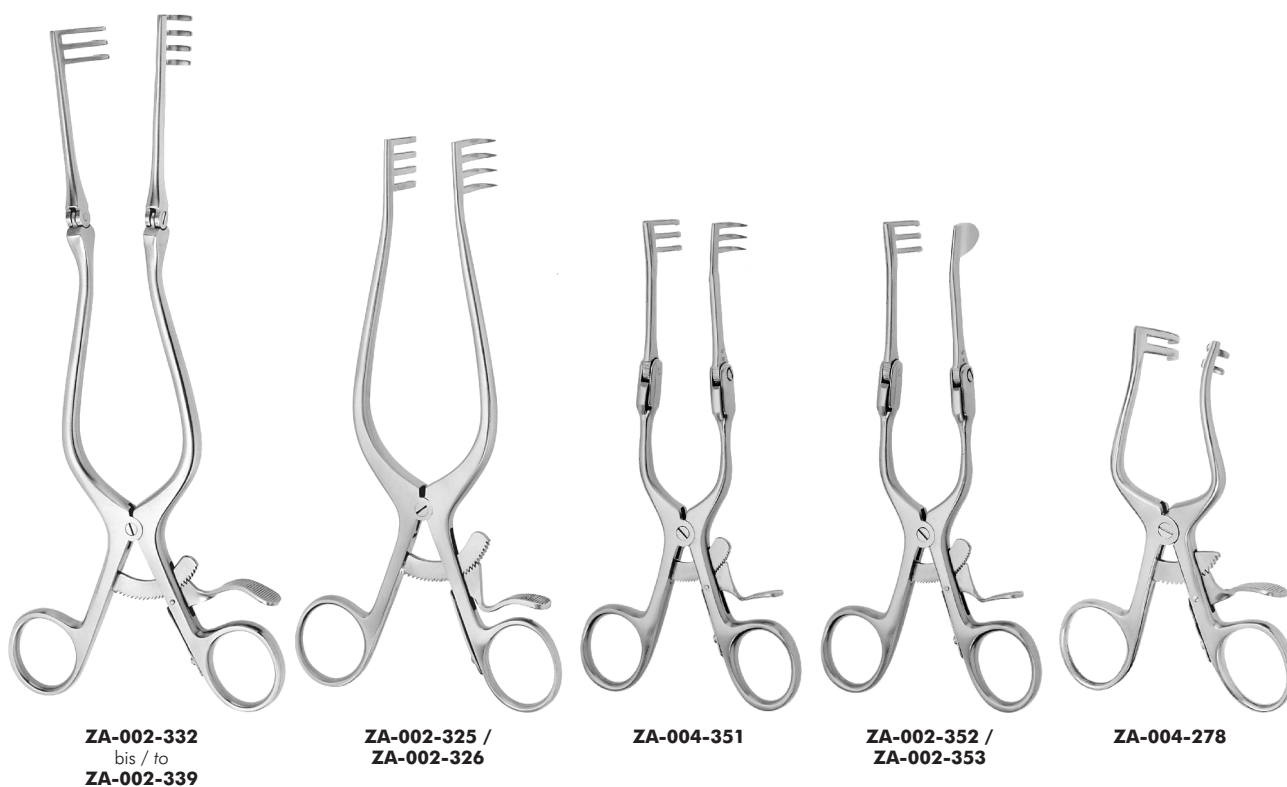

Bestell-Nr. Ordering no.	Bezeichnung Description
<b>ZA-002-325</b>	ADSON Wundsperrer, scharf, 20cm ADSON retractor, sharp, 20cm
<b>ZA-002-326</b>	ADSON Wundsperrer, stumpf, 20cm ADSON retractor, blunt, 20cm
<b>ZA-002-332</b>	BECKMANN-ADSON Wundsperrer, 25x25mm, scharf, 31cm BECKMANN-ADSON retractor, 25x25mm, sharp, 31cm
<b>ZA-002-333</b>	BECKMANN-ADSON Wundsperrer, 25x31mm, scharf, 31cm BECKMANN-ADSON retractor, 25x31mm, sharp, 31cm
<b>ZA-002-334</b>	BECKMANN-ADSON Wundsperrer, 25x40mm, scharf, 31cm BECKMANN-ADSON retractor, 25x40mm, sharp, 31cm
<b>ZA-002-335</b>	BECKMANN-ADSON Wundsperrer, 25x45mm, scharf, 31cm BECKMANN-ADSON retractor, 25x45mm, sharp, 31cm
<b>ZA-002-336</b>	BECKMANN-ADSON Wundsperrer, 25x25mm, stumpf, 31cm BECKMANN-ADSON retractor, 25x25mm, blunt, 31cm
<b>ZA-002-337</b>	BECKMANN-ADSON Wundsperrer, 25x31mm, stumpf, 31cm BECKMANN-ADSON retractor, 25x31mm, blunt, 31cm
<b>ZA-002-338</b>	BECKMANN-ADSON Wundsperrer, 25x40mm, stumpf, 31cm BECKMANN-ADSON retractor, 25x40mm, blunt, 31cm
<b>ZA-003-339</b>	BECKMANN-ADSON Wundsperrer, 25x45mm, stumpf, 31cm BECKMANN-ADSON retractor, 25x45mm, blunt, 31cm
<b>ZA-004-278</b>	FISCH Wundsperrer 2x2 Zähne, stumpf, 13cm FISCH retractor, 2x2 teeth, blunt, 13cm
<b>ZA-004-351</b>	FISCH Wundsperrer mit Gelenken, 3x3 Zähne, 16.5cm FISCH adjustable retractor, 3x3 teeth, 16.5cm
<b>ZA-004-352</b>	FISCH Wundsperrer mit Gelenken, 3x3 Zähne rechts, volles Blatt links, 16.5cm FISCH adjustable retractor, 3x3 teeth right, solid blade left, 16.5cm
<b>ZA-004-353</b>	FISCH Wundsperrer mit Gelenken, 3x3 Zähne links, volles Blatt rechts, 16.5cm FISCH adjustable retractor, 3x3 teeth left, solid blade right, 16.5cm





**ZA-004-333**



**ZA-004-276 /  
ZA-004-277 /  
ZA-004-555 /  
ZA-004-556 /  
ZA-004-707 /  
ZA-004-708**



**ZA-004-334**  
bis / to  
**ZA-004-554**



**ZA-004-337**  
bis / to  
**ZA-004-340**



**ZA-004-335 /  
ZA-004-336**

Bestell-Nr. Ordering no.	Bezeichnung Description
<b>ZA-004-333</b>	SCHUHKNECHT (FISCH) Wundsperrer, 3x3 Zähne, abgewinkelt, 13cm <i>SCHUHKNECHT (FISCH) retractor, 3x3 teeth, angled, 13cm</i>
<b>ZA-004-335</b>	HELMS Wundsperrer, 2 Zähne rechts, volles Blatt links mit atraumatischer Zahnung, 11cm <i>HELMS retractor, 2 prongs right, solid atraumatic blade left, 11cm</i>
<b>ZA-004-336</b>	HELMS Wundsperrer, 2 Zähne links, volles Blatt rechts mit atraumatischer Zahnung, 11cm <i>HELMS retractor, 2 prongs left, solid atraumatic blade right, 11cm</i>
<b>ZA-004-337</b>	PERKINS Wundsperrer, 2 Zähne rechts, gezahntes Blatt links, 11cm <i>PERKINS retractor, 2 prongs right, pointed blade left, 11cm</i>
<b>ZA-004-339</b>	PERKINS Wundsperrer, 3 Zähne rechts, gezahntes Blatt links, 13cm <i>PERKINS retractor, 3 prongs right, pointed blade left, 13cm</i>
<b>ZA-004-338</b>	PERKINS Wundsperrer, 2 Zähne links, gezahntes Blatt rechts, 11cm <i>PERKINS retractor, 2 prongs left, pointed blade right, 11cm</i>
<b>ZA-004-340</b>	PERKINS Wundsperrer, 3 Zähne links, gezahntes Blatt rechts, 13cm <i>PERKINS retractor, 3 prongs left, pointed blade right, 13cm</i>
<b>ZA-004-276</b>	PLESTER Wundsperrer, 2 Zähne rechts, volles Blatt links, 11cm <i>PLESTER retractor, 2 prongs right, solid blade left, 11cm</i>
<b>ZA-004-556</b>	PLESTER Wundsperrer, 2 Zähne rechts, volles Blatt links, 13cm <i>PLESTER retractor, 2 prongs right, solid blade left, 13cm</i>
<b>ZA-004-707</b>	PLESTER Wundsperrer, 3 Zähne rechts, volles Blatt links, 13cm <i>PLESTER retractor, 3 prongs right, solid blade left, 13cm</i>
<b>ZA-004-277</b>	PLESTER Wundsperrer, 2 Zähne links, volles Blatt rechts, 11cm <i>PLESTER retractor, 2 prongs left, solid blade right, 11cm</i>
<b>ZA-004-555</b>	PLESTER Wundsperrer, 2 Zähne links, volles Blatt rechts, 13cm <i>PLESTER retractor, 2 prongs left, solid blade right, 13cm</i>
<b>ZA-004-708</b>	PLESTER Wundsperrer, 3 Zähne links, volles Blatt rechts, 13cm <i>PLESTER retractor, 3 prongs left, solid blade right, 13cm</i>
<b>ZA-004-334</b>	PLESTER Wundsperrer 2x2 Zähne, stumpf, 11cm <i>PLESTER retractor, 2x2 teeth, blunt, 11cm</i>
<b>ZA-004-334-1</b>	PLESTER Wundsperrer 2x2 Zähne, stumpf, 13cm <i>PLESTER retractor, 2x2 teeth, blunt, 13cm</i>
<b>ZA-004-553</b>	PLESTER Wundsperrer 2x2 Zähne, scharf, 10cm <i>PLESTER retractor, 2x2 teeth, sharp, 10cm</i>
<b>ZA-004-554</b>	PLESTER Wundsperrer 2x2 Zähne, scharf, 13cm <i>PLESTER retractor, 2x2 teeth, sharp, 13cm</i>



**ZA-004-559 /  
ZA-004-560**



**ZA-004-341  
bis / to  
ZA-004-344**



**ZA-004-345 /  
ZA-004-346**



**ZA-004-347 /  
ZA-004-348**



**ZA-004-349**

<b>Bestell-Nr. Ordering no.</b>	<b>Bezeichnung Description</b>
<b>ZA-004-341</b>	WIGAND Wundsperrer für die Tympanoplastik, für linkes Ohr, rechte Seite mit Dornen, 11cm <i>WIGAND retractor used for tympanoplasty, for the left ear, pointed blade right, 11cm</i>
<b>ZA-004-343</b>	WIGAND Wundsperrer für die Tympanoplastik, für linkes Ohr, rechte Seite mit Dornen, 13cm <i>WIGAND retractor used for tympanoplasty, for the left ear, pointed blade right, 13cm</i>
<b>ZA-004-342</b>	WIGAND Wundsperrer für die Tympanoplastik, für rechtes Ohr, linke Seite mit Dornen, 11cm <i>WIGAND retractor used for tympanoplasty, for the right ear, pointed blade left, 11cm</i>
<b>ZA-004-344</b>	WIGAND Wundsperrer für die Tympanoplastik, für rechtes Ohr, linke Seite mit Dornen, 13cm <i>WIGAND retractor used for tympanoplasty, for the right ear, pointed blade left, 13cm</i>
<b>ZA-004-347</b>	WIGAND Laschensperrer für die Tympanoplastik, schmales gerieftes Blatt links, 2 Zähne rechts, 11cm <i>WIGAND retractor used for Tympanoplasty, slender serrated blade left, 2 prongs right, 11cm</i>
<b>ZA-004-348</b>	WIGAND Laschensperrer für die Tympanoplastik, schmales gerieftes Blatt rechts, 2 Zähne links, 11cm <i>WIGAND retractor used for Tympanoplasty, slender serrated blade right, 2 prongs left, 11cm</i>
<b>ZA-004-345</b>	JANSEN Wundsperrer für die Tympanoplastik, gefensterter Blatt links, 3 Zähne rechts, 13cm <i>JANSEN retractor used for Tympanoplasty, fenestrated blade left, 3 prongs right, 13cm</i>
<b>ZA-004-346</b>	JANSEN Wundsperrer für die Tympanoplastik, gefensterter Blatt rechts, 3 Zähne links, 13cm <i>JANSEN retractor used for Tympanoplasty, fenestrated blade right, 3 prongs left, 13cm</i>
<b>ZA-004-349</b>	Wundsperrer selbshaltend, gekreuzt, 4x4 stumpfe Zähne, 10cm <i>Retractor self-retaining, crossed, 4x4 blunt prongs, 10cm</i>
<b>ZA-004-559</b>	BECKMANN Wundsperrer, 3 Zähne links, rechte Seite voll, 16.5cm <i>BECKMANN retractor, 3 prongs left, solid blade right, 16.5m</i>
<b>ZA-004-660</b>	BECKMANN Wundsperrer, 3 Zähne rechts, linke Seite voll, 16.5cm <i>BECKMANN retractor, 3 prongs right, solid blade left, 16.5m</i>

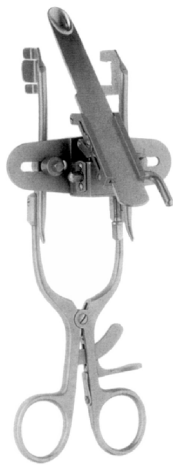

ZA-004-356



ZA-004-354 /  
ZA-004-355



ZA-004-350

Bestell-Nr. Ordering no.	Bezeichnung Description
ZA-004-350	SULTAN Wundsperrer, mit 2 Valven gezahnt, Blattlänge 4cm, 13cm <i>SULTAN retractor, 2 toothed blades, length of blades 4cm, 13cm</i>
ZA-004-354	HOUSE Wundsperrer mit Gelenken, 3x3 Zähne rechts, volles Blatt links mit scharfen Stiften, 16.5cm <i>HOUSE adjustable retractor, 3x3 prongs right, solid blade left with sharp pins, 16.5cm</i>
ZA-004-355	HOUSE Wundsperrer mit Gelenken, 3x3 Zähne links, volles Blatt rechts mit scharfen Stiften, 16.5cm <i>HOUSE adjustable retractor, 3x3 prongs left, solid blade right with sharp pins, 16.5cm</i>
ZA-004-356	FISH Dura Retraktor, komplett mit 3 Spatel und 1 Schlüssel, 18cm <i>FISH dura retractor, complete including 3 spatulas and 1 key, 18cm</i>
ZA-004-357	Spatel, gerade, kurz für ZA-004-356 (ohne Abbildung) <i>Spatula, straight, short used for ZA-004-356 (without illustration)</i>
ZA-004-358	Spatel, gerade, lang für ZA-004-356 (ohne Abbildung) <i>Spatula, straight, long used for ZA-004-356 (without illustration)</i>
ZA-004-359	Spatel, gebogen, lang für ZA-004-356 (ohne Abbildung) <i>Spatula, curved, long used for ZA-004-356 (without illustration)</i>
ZA-004-360	Schlüssel für ZA-004-356 (ohne Abbildung) <i>Key for ZA-004-356 (without illustration)</i>



**ZA-001-966**



**ZA-001-894**



**ZA-001-891**

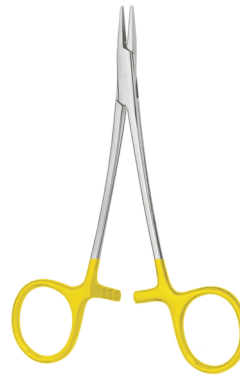

**ZA-001-960**



**ZA-001-889**

<b>Bestell-Nr.</b> <b>Ordering no.</b>	<b>Bezeichnung</b> <b>Description</b>
<b>ZA-001-889</b>	DERF Nadelhalter, 12cm <i>DERF needle holder, 12cm</i>
<b>ZA-001-960</b>	DERF Nadelhalter, 12cm, TC <i>DERF needle holder, 12cm, TC</i>
<b>ZA-001-891</b>	COLLIER Nadelhalter, 12.5cm <i>COLLIER needle holder, 12.5cm</i>
<b>ZA-001-894</b>	HALSEY Nadelhalter, 13cm <i>HALSEY needle holder, 13cm</i>
<b>ZA-001-966</b>	HALSEY Nadelhalter, 13cm, TC <i>HALSEY needle holder, 13cm, TC</i>



**ZA-001-928**  
bis / to  
**ZA-001-934**



**ZA-001-906**  
bis / to  
**ZA-001-911**



**ZA-001-969**  
bis / to  
**ZA-001-972**



**ZA-001-896 /**  
**ZA-001-897**

Bestell-Nr. Ordering no.	Bezeichnung Description
<b>ZA-001-896</b>	CRILE-WOOD Nadelhalter, 15cm <i>CRILE-WOOD needle holder, 15cm</i>
<b>ZA-001-897</b>	CRILE-WOOD Nadelhalter, 18cm <i>CRILE-WOOD needle holder, 18cm</i>
<b>ZA-001-969</b>	CRILE-WOOD Nadelhalter, 15cm, TC <i>CRILE-WOOD needle holder, 15cm, TC</i>
<b>ZA-001-970</b>	CRILE-WOOD Nadelhalter, 18cm, TC <i>CRILE-WOOD needle holder, 18cm, TC</i>
<b>ZA-001-971</b>	CRILE-WOOD Nadelhalter, 20cm, TC <i>CRILE-WOOD needle holder, 20cm, TC</i>
<b>ZA-001-972</b>	CRILE-WOOD Nadelhalter, 23cm, TC <i>CRILE-WOOD needle holder, 23cm, TC</i>
<b>ZA-001-906</b>	MAYO-HEGAR Nadelhalter, 14cm <i>MAYO-HEGAR needle holder, 14cm</i>
<b>ZA-001-907</b>	MAYO-HEGAR Nadelhalter, 16cm <i>MAYO-HEGAR needle holder, 16cm</i>
<b>ZA-001-908</b>	MAYO-HEGAR Nadelhalter, 18cm <i>MAYO-HEGAR needle holder, 18cm</i>
<b>ZA-001-909</b>	MAYO-HEGAR Nadelhalter, 20cm <i>MAYO-HEGAR needle holder, 20cm</i>
<b>ZA-001-910</b>	MAYO-HEGAR Nadelhalter, 24cm <i>MAYO-HEGAR needle holder, 24cm</i>
<b>ZA-001-911</b>	MAYO-HEGAR Nadelhalter, 26cm <i>MAYO-HEGAR needle holder, 26cm</i>
<b>ZA-001-928</b>	MAYO-HEGAR Nadelhalter, 14cm, TC <i>MAYO-HEGAR needle holder, 14cm, TC</i>
<b>ZA-001-929</b>	MAYO-HEGAR Nadelhalter, 16cm, TC <i>MAYO-HEGAR needle holder, 16cm, TC</i>
<b>ZA-001-930</b>	MAYO-HEGAR Nadelhalter, 18cm, TC <i>MAYO-HEGAR needle holder, 18cm, TC</i>
<b>ZA-001-931</b>	MAYO-HEGAR Nadelhalter, 20cm, TC <i>MAYO-HEGAR needle holder, 20cm, TC</i>
<b>ZA-001-932</b>	MAYO-HEGAR Nadelhalter, 24cm, TC <i>MAYO-HEGAR needle holder, 24cm, TC</i>
<b>ZA-001-933</b>	MAYO-HEGAR Nadelhalter, 26cm, TC <i>MAYO-HEGAR needle holder, 26cm, TC</i>
<b>ZA-001-934</b>	MAYO-HEGAR Nadelhalter, 30cm, TC <i>MAYO-HEGAR needle holder, 30cm, TC</i>



**ZA-001-935**  
bis / to  
**ZA-001-937**



**ZA-004-694 /**  
**ZA-004-695**



**ZA-001-963**

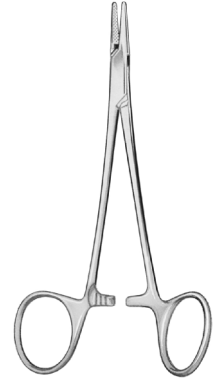

**ZA-004-696**

<b>Bestell-Nr.</b> <b>Ordering no.</b>	<b>Bezeichnung</b> <b>Description</b>
<b>ZA-001-935</b>	DEBAKEY Nadelhalter, 18cm, TC <i>DEBAKEY needle holder, 18cm, TC</i>
<b>ZA-001-936</b>	DEBAKEY Nadelhalter, 20cm, TC <i>DEBAKEY needle holder, 20cm, TC</i>
<b>ZA-001-937</b>	DEBAKEY Nadelhalter, 23cm, TC <i>DEBAKEY needle holder, 23cm, TC</i>
<b>ZA-004-696</b>	NEIVERT Nadelhalter, 13cm <i>NEIVERT needle holder, 13cm</i>
<b>ZA-001-963</b>	NEIVERT Nadelhalter, 13cm, TC <i>NEIVERT needle holder, 13cm, TC</i>
<b>ZA-004-694</b>	SENNING Nadelhalter, 17cm, TC <i>SENNING needle holder, 17cm, TC</i>
<b>ZA-004-695</b>	SENNING Nadelhalter, 15cm, TC <i>SENNING needle holder, 15cm, TC</i>



**ZA-004-452 /  
ZA-004-453**



**ZA-004-454 /  
ZA-004-455**



**ZA-004-448 /  
ZA-004-449**



**ZA-004-450 /  
ZA-004-451**



**ZA-004-460 /  
ZA-004-461**



**ZA-004-400 /  
ZA-004-401 /  
ZA-004-404**



**ZA-004-402 /  
ZA-004-403 /  
ZA-004-405**

Bestell-Nr. Ordering no.	Bezeichnung Description
<b>ZA-004-400</b>	BARRAQUER-TROUTMAN Mikro-Nadelhalter, sehr fein, gerade, ohne Sperre, 10cm <i>BARRAQUER-TROUTMAN micro-needleholder, very delicate, straight, without ratchet, 10cm</i>
<b>ZA-004-401</b>	BARRAQUER-TROUTMAN Mikro-Nadelhalter, sehr fein, gebogen, ohne Sperre, 10cm <i>BARRAQUER-TROUTMAN micro-needleholder, very delicate, curved, without ratchet, 10cm</i>
<b>ZA-004-402</b>	BARRAQUER-TROUTMAN Mikro-Nadelhalter, sehr fein, gerade, mit Sperre, 10cm <i>BARRAQUER-TROUTMAN micro-needleholder, very delicate, straight, with ratchet, 10cm</i>
<b>ZA-004-403</b>	BARRAQUER-TROUTMAN Mikro-Nadelhalter, sehr fein, gebogen, mit Sperre, 10cm <i>BARRAQUER-TROUTMAN micro-needleholder, very delicate, curved, with ratchet, 10cm</i>
<b>ZA-004-460</b>	BARRAQUER-TROUTMAN Mikro-Nadelhalter, abgewinkelt, ohne Sperre, 11.5cm <i>BARRAQUER-TROUTMAN micro-needleholder, angled, without ratchet, 11.5cm</i>
<b>ZA-004-461</b>	BARRAQUER-TROUTMAN Mikro-Nadelhalter, abgewinkelt, mit Sperre, 11.5cm <i>BARRAQUER-TROUTMAN micro-needleholder, angled, with ratchet, 11.5cm</i>
<b>ZA-004-404</b>	BARRAQUER Mikro-Nadelhalter, sehr fein, gebogen, ohne Sperre, 12.5cm <i>BARRAQUER micro-needleholder, very delicate, curved, without ratchet, 12.5cm</i>
<b>ZA-004-405</b>	BARRAQUER Mikro-Nadelhalter, sehr fein, gebogen, mit Sperre, 12.5cm <i>BARRAQUER micro-needleholder, very delicate, curved, with ratchet, 12.5cm</i>
<b>ZA-004-448</b>	BARRAQUER Mikro-Nadelhalter, gerade, ohne Sperre, 13cm <i>BARRAQUER micro-needleholder, straight, without ratchet, 13cm</i>
<b>ZA-004-449</b>	BARRAQUER Mikro-Nadelhalter, gebogen, ohne Sperre, 13cm <i>BARRAQUER micro-needleholder, curved, without ratchet, 13cm</i>
<b>ZA-004-450</b>	BARRAQUER Mikro-Nadelhalter, gerade, mit Sperre, 13cm <i>BARRAQUER micro-needleholder, straight, with ratchet, 13cm</i>
<b>ZA-004-451</b>	BARRAQUER Mikro-Nadelhalter, gebogen, mit Sperre, 13cm <i>BARRAQUER micro-needleholder, curved, with ratchet, 13cm</i>
<b>ZA-004-452</b>	BARRAQUER Mikro-Nadelhalter, Originalmodell, gerade, ohne Sperre, 13cm <i>BARRAQUER micro-needleholder, original model, straight, without ratchet, 13cm</i>
<b>ZA-004-453</b>	BARRAQUER Mikro-Nadelhalter, Originalmodell, gebogen, ohne Sperre, 13cm <i>BARRAQUER micro-needleholder, original model, curved, without ratchet, 13cm</i>
<b>ZA-004-454</b>	BARRAQUER Mikro-Nadelhalter, Originalmodell, gerade, mit Sperre, 13cm <i>BARRAQUER micro-needleholder, original model, straight, with ratchet, 13cm</i>
<b>ZA-004-455</b>	BARRAQUER Mikro-Nadelhalter, Originalmodell, gebogen, mit Sperre, 13cm <i>BARRAQUER micro-needleholder, original model, curved, with ratchet, 13cm</i>





**ZA-004-470 /**  
**ZA-004-471**

**ZA-004-472 /**  
**ZA-004-473**

**ZA-004-466**  
 bis / to  
**ZA-004-469**

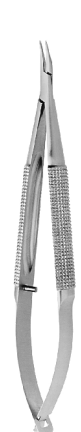
**ZA-004-462 /**  
**ZA-004-463**

**ZA-004-464 /**  
**ZA-004-465**

**ZA-004-456 /**  
**ZA-004-457**

**ZA-004-458 /**  
**ZA-004-459**

Bestell-Nr. Ordering no.	Bezeichnung Description
<b>ZA-004-456</b>	BARRAQUER Mikro-Nadelhalter, gerade, ohne Sperre, 11.5cm <i>BARRAQUER micro-needleholder, straight, without ratchet, 11.5cm</i>
<b>ZA-004-457</b>	BARRAQUER Mikro-Nadelhalter, gebogen, ohne Sperre, 11.5cm <i>BARRAQUER micro-needleholder, curved, without ratchet, 11.5cm</i>
<b>ZA-004-458</b>	BARRAQUER Mikro-Nadelhalter, gerade, mit Sperre, 11.5cm <i>BARRAQUER micro-needleholder, straight, with ratchet, 11.5cm</i>
<b>ZA-004-459</b>	BARRAQUER Mikro-Nadelhalter, gebogen, mit Sperre, 11.5cm <i>BARRAQUER micro-needleholder, curved, with ratchet, 11.5cm</i>
<b>ZA-004-462</b>	BARRAQUER Mikro-Nadelhalter, gerade, ohne Sperre, 12cm <i>BARRAQUER micro-needleholder, straight, without ratchet, 12cm</i>
<b>ZA-004-463</b>	BARRAQUER Mikro-Nadelhalter, gebogen, ohne Sperre, 12cm <i>BARRAQUER micro-needleholder, curved, without ratchet, 12cm</i>
<b>ZA-004-464</b>	BARRAQUER Mikro-Nadelhalter, gerade, mit Sperre, 12cm <i>BARRAQUER micro-needleholder, straight, with ratchet, 12cm</i>
<b>ZA-004-465</b>	BARRAQUER Mikro-Nadelhalter, gebogen, mit Sperre, 12cm <i>BARRAQUER micro-needleholder, curved, with ratchet, 12cm</i>
<b>ZA-004-466</b>	BARRAQUER Mikro-Nadelhalter, delikat, gerade, ohne Sperre, 13.5cm <i>BARRAQUER micro-needleholder, very fine, straight, without ratchet, 13.5cm</i>
<b>ZA-004-467</b>	BARRAQUER Mikro-Nadelhalter, delikat, gebogen, ohne Sperre, 13.5cm <i>BARRAQUER micro-needleholder, very fine, curved, without ratchet, 13.5cm</i>
<b>ZA-004-468</b>	BARRAQUER Mikro-Nadelhalter, delikat, gerade, mit Sperre, 13.5cm <i>BARRAQUER micro-needleholder, very fine, straight, with ratchet, 13.5cm</i>
<b>ZA-004-469</b>	BARRAQUER Mikro-Nadelhalter, delikat, gebogen, mit Sperre, 13.5cm <i>BARRAQUER micro-needleholder, very fine, curved, with ratchet, 13.5cm</i>
<b>ZA-004-470</b>	BARRAQUER Mikro-Nadelhalter, gerade, ohne Sperre, 14cm <i>BARRAQUER micro-needleholder, straight, without ratchet, 14cm</i>
<b>ZA-004-471</b>	BARRAQUER Mikro-Nadelhalter, gebogen, ohne Sperre, 14cm <i>BARRAQUER micro-needleholder, curved, without ratchet, 14cm</i>
<b>ZA-004-472</b>	BARRAQUER Mikro-Nadelhalter, gerade, mit Sperre, 14cm <i>BARRAQUER micro-needleholder, straight, with ratchet, 14cm</i>
<b>ZA-004-473</b>	BARRAQUER Mikro-Nadelhalter, gebogen, mit Sperre, 14cm <i>BARRAQUER micro-needleholder, curved, with ratchet, 14cm</i>



**ZA-002-003 /**  
**ZA-002-004 /**  
**ZA-004-406 /**  
**ZA-004-407**



**ZA-004-408 /**  
**ZA-004-409**



**ZA-004-410**  
bis / to  
**ZA-004-413**



**ZA-004-418 /**  
**ZA-004-420 /**  
**ZA-004-422 /**  
**ZA-004-424**



**ZA-004-419 /**  
**ZA-004-421 /**  
**ZA-004-423 /**  
**ZA-004-425**

<b>Bestell-Nr.</b> <b>Ordering no.</b>	<b>Bezeichnung</b> <b>Description</b>
<b>ZA-002-003</b>	CASTROVIEJO Nadelhalter, gerade, fein, 14cm CASTROVIEJO <i>needle holder, straight, fine, 14cm</i>
<b>ZA-002-004</b>	CASTROVIEJO Nadelhalter, gebogen, fein, 14cm CASTROVIEJO <i>needle holder, curved, fine, 14cm</i>
<b>ZA-004-406</b>	CASTROVIEJO Mikro-Nadelhalter, sehr fein, gerade, ohne Sperre, 14cm CASTROVIEJO <i>micro-needleholder, very delicate, straight, without ratchet, 14cm</i>
<b>ZA-004-407</b>	CASTROVIEJO Mikro-Nadelhalter, sehr fein, gebogen, ohne Sperre, 14cm CASTROVIEJO <i>micro-needleholder, very delicate, curved, without ratchet, 14cm</i>
<b>ZA-004-408</b>	CASTROVIEJO Mikro-Nadelhalter, sehr fein, gerade, mit Sperre, 14cm CASTROVIEJO <i>micro-needleholder, very delicate, straight, with ratchet, 14cm</i>
<b>ZA-004-409</b>	CASTROVIEJO Mikro-Nadelhalter, sehr fein, gebogen, mit Sperre, 14cm CASTROVIEJO <i>micro-needleholder, very delicate, curved, with ratchet, 14cm</i>
<b>ZA-004-410</b>	CASTROVIEJO Mikro-Nadelhalter, sehr fein, gerade, ohne Sperre, 14cm, TC CASTROVIEJO <i>micro-needleholder, very delicate, straight, without ratchet, 14cm, TC</i>
<b>ZA-004-411</b>	CASTROVIEJO Mikro-Nadelhalter, sehr fein, gebogen, ohne Sperre, 14cm, TC CASTROVIEJO <i>micro-needleholder, very delicate, curved, without ratchet, 14cm, TC</i>
<b>ZA-004-412</b>	CASTROVIEJO Mikro-Nadelhalter, sehr fein, gerade, glatt, mit Sperre, 14cm, TC CASTROVIEJO <i>micro-needleholder, very delicate, straight, smooth, with ratchet, 14cm, TC</i>
<b>ZA-004-413</b>	CASTROVIEJO Mikro-Nadelhalter, sehr fein, gebogen, glatt, mit Sperre, 14cm, TC CASTROVIEJO <i>micro-needleholder, very delicate, curved, smooth, with ratchet, 14cm, TC</i>
<b>ZA-004-418</b>	CASTROVIEJO Mikro-Nadelhalter, fein abgesetzt, gerade, mit Sperre, 9cm CASTROVIEJO <i>micro-needleholder, fine jaws, straight, with ratchet, 9cm</i>
<b>ZA-004-422</b>	CASTROVIEJO Mikro-Nadelhalter, fein abgesetzt, gerade, mit Sperre, 13cm CASTROVIEJO <i>micro-needleholder, fine jaws, straight, with ratchet, 13cm</i>
<b>ZA-004-420</b>	CASTROVIEJO Mikro-Nadelhalter, fein abgesetzt, gebogen, mit Sperre, 9cm CASTROVIEJO <i>micro-needleholder, fine jaws, curved, with ratchet, 9cm</i>
<b>ZA-004-424</b>	CASTROVIEJO Mikro-Nadelhalter, fein abgesetzt, gebogen, mit Sperre, 13cm CASTROVIEJO <i>micro-needleholder, fine jaws, curved, with ratchet, 13cm</i>
<b>ZA-004-419</b>	CASTROVIEJO Mikro-Nadelhalter, fein abgesetzt, gerade, ohne Sperre, 9cm CASTROVIEJO <i>micro-needleholder, fine jaws, straight, without ratchet, 9cm</i>
<b>ZA-004-423</b>	CASTROVIEJO Mikro-Nadelhalter, fein abgesetzt, gerade, ohne Sperre, 13cm CASTROVIEJO <i>micro-needleholder, fine jaws, straight, without ratchet, 13cm</i>
<b>ZA-004-421</b>	CASTROVIEJO Mikro-Nadelhalter, fein abgesetzt, gebogen, ohne Sperre, 9cm CASTROVIEJO <i>micro-needleholder, fine jaws, curved, without ratchet, 9cm</i>
<b>ZA-004-425</b>	CASTROVIEJO Mikro-Nadelhalter, fein abgesetzt, gebogen, ohne Sperre, 13cm CASTROVIEJO <i>micro-needleholder, fine jaws, curved, without ratchet, 13cm</i>

**ZA-004-432 /**  
**ZA-004-440 /**  
**ZA-004-433 /**  
**ZA-004-441**

**ZA-004-434 /**  
**ZA-004-442 /**  
**ZA-004-435 /**  
**ZA-004-443**

**ZA-004-436 /**  
**ZA-004-444 /**  
**ZA-004-437 /**  
**ZA-004-445**

**ZA-004-438 /**  
**ZA-004-446 /**  
**ZA-004-439 /**  
**ZA-004-447**

**ZA-004-426 /**  
**ZA-004-427 /**  
**ZA-004-430 /**  
**ZA-004-431**

**ZA-004-428 /**  
**ZA-004-429**

Bestell-Nr. Ordering no.	Bezeichnung Description
<b>ZA-004-426</b>	CASTROVIEJO Mikro-Nadelhalter, sehr fein, gerade, ohne Sperre, 14cm, TC CASTROVIEJO <i>micro-needleholder, very delicate, straight, without ratchet, 14cm, TC</i>
<b>ZA-004-427</b>	CASTROVIEJO Mikro-Nadelhalter, sehr fein, gebogen, ohne Sperre, 14cm, TC CASTROVIEJO <i>micro-needleholder, very delicate, curved, without ratchet, 14cm, TC</i>
<b>ZA-004-428</b>	CASTROVIEJO Mikro-Nadelhalter, sehr fein, gerade, glatt, mit Sperre, 14cm, TC CASTROVIEJO <i>micro-needleholder, very delicate, straight, smooth, with ratchet, 14cm, TC</i>
<b>ZA-004-429</b>	CASTROVIEJO Mikro-Nadelhalter, sehr fein, gebogen, glatt, mit Sperre, 14cm, TC CASTROVIEJO <i>micro-needleholder, very delicate, curved, smooth, with ratchet, 14cm, TC</i>
<b>ZA-004-430</b>	CASTROVIEJO Mikro-Nadelhalter, sehr fein, gerade, glatt, ohne Sperre, 14cm, TC CASTROVIEJO <i>micro-needleholder, very delicate, straight, smooth, without ratchet, 14cm, TC</i>
<b>ZA-004-431</b>	CASTROVIEJO Mikro-Nadelhalter, sehr fein, gebogen, glatt, ohne Sperre, 14cm, TC CASTROVIEJO <i>micro-needleholder, very delicate, curved, smooth, without ratchet, 14cm, TC</i>
<b>ZA-004-432</b>	CASTROVIEJO Mikro-Nadelhalter, gerade, mit Sperre, 18cm, TC CASTROVIEJO <i>micro-needleholder, straight, with ratchet, 18cm, TC</i>
<b>ZA-004-440</b>	CASTROVIEJO Mikro-Nadelhalter, gerade, mit Sperre, 20cm, TC CASTROVIEJO <i>micro-needleholder, straight, with ratchet, 20cm, TC</i>
<b>ZA-004-433</b>	CASTROVIEJO Mikro-Nadelhalter, gebogen, mit Sperre, 18cm, TC CASTROVIEJO <i>micro-needleholder, curved, with ratchet, 18cm, TC</i>
<b>ZA-004-441</b>	CASTROVIEJO Mikro-Nadelhalter, gebogen, mit Sperre, 20cm, TC CASTROVIEJO <i>micro-needleholder, curved, with ratchet, 20cm, TC</i>
<b>ZA-004-434</b>	CASTROVIEJO Mikro-Nadelhalter, gerade, ohne Sperre, 18cm, TC CASTROVIEJO <i>micro-needleholder, straight, without ratchet, 18cm, TC</i>
<b>ZA-004-442</b>	CASTROVIEJO Mikro-Nadelhalter, gerade, ohne Sperre, 20cm, TC CASTROVIEJO <i>micro-needleholder, straight, without ratchet, 20cm, TC</i>
<b>ZA-004-435</b>	CASTROVIEJO Mikro-Nadelhalter, gebogen, ohne Sperre, 18cm, TC CASTROVIEJO <i>micro-needleholder, curved, without ratchet, 18cm, TC</i>
<b>ZA-004-443</b>	CASTROVIEJO Mikro-Nadelhalter, gebogen, ohne Sperre, 20cm, TC CASTROVIEJO <i>micro-needleholder, curved, without ratchet, 20cm, TC</i>
<b>ZA-004-436</b>	CASTROVIEJO Mikro-Nadelhalter, gerade, glatt, mit Sperre, 18cm, TC CASTROVIEJO <i>micro-needleholder, straight, smooth, with ratchet, 18cm, TC</i>
<b>ZA-004-444</b>	CASTROVIEJO Mikro-Nadelhalter, gerade, glatt, mit Sperre, 20cm, TC CASTROVIEJO <i>micro-needleholder, straight, smooth, with ratchet, 20cm, TC</i>
<b>ZA-004-437</b>	CASTROVIEJO Mikro-Nadelhalter, gebogen, glatt, mit Sperre, 18cm, TC CASTROVIEJO <i>micro-needleholder, curved, smooth, with ratchet, 18cm, TC</i>
<b>ZA-004-445</b>	CASTROVIEJO Mikro-Nadelhalter, gebogen, glatt, mit Sperre, 20cm, TC CASTROVIEJO <i>micro-needleholder, curved, smooth, with ratchet, 20cm, TC</i>
<b>ZA-004-438</b>	CASTROVIEJO Mikro-Nadelhalter, gerade, glatt, ohne Sperre, 18cm, TC CASTROVIEJO <i>micro-needleholder, straight, smooth, without ratchet, 18cm, TC</i>
<b>ZA-004-446</b>	CASTROVIEJO Mikro-Nadelhalter, gerade, glatt, ohne Sperre, 20cm, TC CASTROVIEJO <i>micro-needleholder, straight, smooth, without ratchet, 20cm, TC</i>
<b>ZA-004-439</b>	CASTROVIEJO Mikro-Nadelhalter, gebogen, glatt, ohne Sperre, 18cm, TC CASTROVIEJO <i>micro-needleholder, curved, smooth, without ratchet, 18cm, TC</i>
<b>ZA-004-447</b>	CASTROVIEJO Mikro-Nadelhalter, gebogen, glatt, ohne Sperre, 20cm, TC CASTROVIEJO <i>micro-needleholder, curved, smooth, without ratchet, 20cm, TC</i>

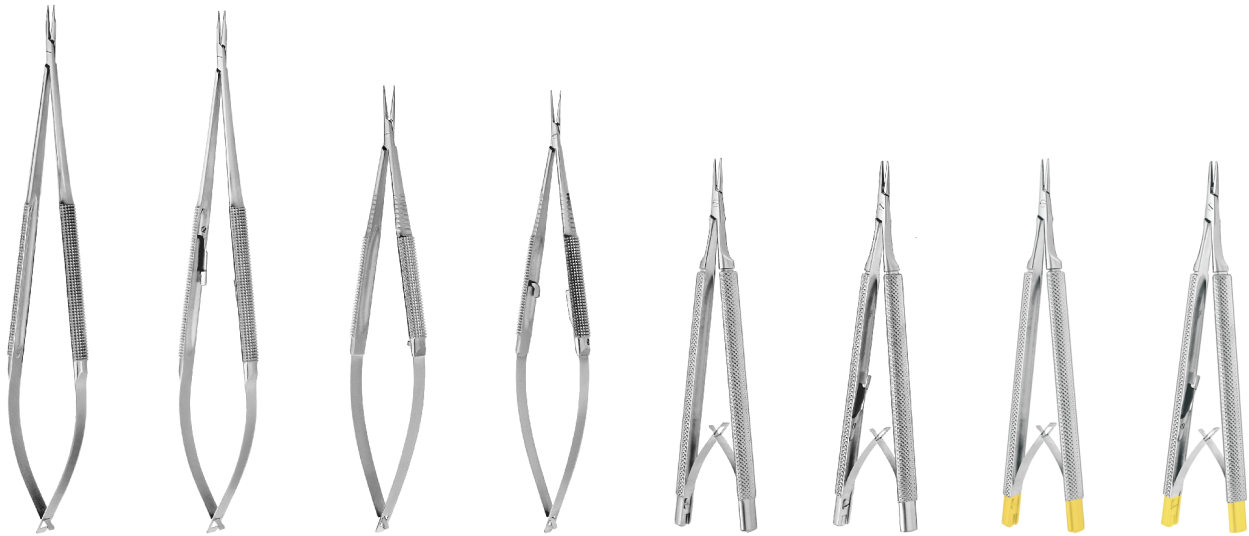

**ZA-004-478 /  
ZA-004-479**

**ZA-004-480 /  
ZA-004-481**

**ZA-004-474 /  
ZA-004-475**

**ZA-004-476 /  
ZA-004-477**

**ZA-004-482 /  
ZA-004-483**

**ZA-004-484 /  
ZA-004-485**

**ZA-004-486 /  
ZA-004-487**

**ZA-004-488 /  
ZA-004-489**

<b>Bestell-Nr. Ordering no.</b>	<b>Bezeichnung Description</b>
<b>ZA-004-474</b>	REILL Mikro-Nadelhalter, feines Maul, gerade, ohne Sperre, 15cm <i>REILL micro-needleholder, extra delicate, straight, without ratchet, 15cm</i>
<b>ZA-004-475</b>	REILL Mikro-Nadelhalter, feines Maul, gebogen, ohne Sperre, 15cm <i>REILL micro-needleholder, extra delicate, curved, without ratchet, 15cm</i>
<b>ZA-004-476</b>	REILL Mikro-Nadelhalter, feines Maul, gerade, mit Sperre, 15cm <i>REILL micro-needleholder, extra delicate, straight, with ratchet, 15cm</i>
<b>ZA-004-477</b>	REILL Mikro-Nadelhalter, feines Maul, gebogen, mit Sperre, 15cm <i>REILL micro-needleholder, extra delicate, curved, with ratchet, 15cm</i>
<b>ZA-004-478</b>	Mikro-Nadelhalter mit Rundgriff, gerade, ohne Sperre, 18cm <i>Micro-needleholder with round handle, straight, without ratchet, 18cm</i>
<b>ZA-004-479</b>	Mikro-Nadelhalter mit Rundgriff, gebogen, ohne Sperre, 18cm <i>Micro-needleholder with round handle, curved, without ratchet, 18cm</i>
<b>ZA-004-480</b>	Mikro-Nadelhalter mit Rundgriff, gerade, mit Sperre, 18cm <i>Micro-needleholder with round handle, straight, with ratchet, 18cm</i>
<b>ZA-004-481</b>	Mikro-Nadelhalter mit Rundgriff, gebogen, mit Sperre, 18cm <i>Micro-needleholder with round handle, curved, with ratchet, 18cm</i>
<b>ZA-004-482</b>	Mikro-Nadelhalter, neues Modell, gerade, ohne Sperre, 12cm <i>Micro-needleholder, new model, straight, without ratchet, 12cm</i>
<b>ZA-004-483</b>	Mikro-Nadelhalter, neues Modell, gebogen, ohne Sperre, 12cm <i>Micro-needleholder, new model, curved, without ratchet, 12cm</i>
<b>ZA-004-484</b>	Mikro-Nadelhalter, neues Modell, gerade, mit Sperre, 12cm <i>Micro-needleholder, new model, straight, with ratchet, 12cm</i>
<b>ZA-004-485</b>	Mikro-Nadelhalter, neues Modell, gebogen, mit Sperre, 12cm <i>Micro-needleholder, new model, curved, with ratchet, 12cm</i>
<b>ZA-004-486</b>	Mikro-Nadelhalter, neues Modell, gerade, ohne Sperre, 12cm, TC <i>Micro-needleholder, new model, straight, without ratchet, 12cm, TC</i>
<b>ZA-004-487</b>	Mikro-Nadelhalter, neues Modell, gebogen, ohne Sperre, 12cm, TC <i>Micro-needleholder, new model, curved, without ratchet, 12cm, TC</i>
<b>ZA-004-488</b>	Mikro-Nadelhalter, neues Modell, gerade, mit Sperre, 12cm, TC <i>Micro-needleholder, new model, straight, with ratchet, 12cm, TC</i>
<b>ZA-004-489</b>	Mikro-Nadelhalter, neues Modell, gebogen, mit Sperre, 12cm, TC <i>Micro-needleholder, new model, curved, with ratchet, 12cm, TC</i>



**ZA-004-672**  
bis / to  
**ZA-004-679**

<b>Bestell-Nr.</b> <b>Ordering no.</b>	<b>Bezeichnung</b> <b>Description</b>
<b>ZA-004-672</b>	YASARGIL Mikro-Nadelhalter, bayonett, gerade, 16cm YASARGIL <i>micro-needleholder, bayonett, straight, 16cm</i>
<b>ZA-004-673</b>	YASARGIL Mikro-Nadelhalter, bayonett, gerade, 18cm YASARGIL <i>micro-needleholder, bayonett, straight, 18cm</i>
<b>ZA-004-674</b>	YASARGIL Mikro-Nadelhalter, bayonett, gerade, 20cm YASARGIL <i>micro-needleholder, bayonett, straight, 20cm</i>
<b>ZA-004-675</b>	YASARGIL Mikro-Nadelhalter, bayonett, gerade, 22.5cm YASARGIL <i>micro-needleholder, bayonett, straight, 22.5cm</i>
<b>ZA-004-676</b>	YASARGIL Mikro-Nadelhalter, bayonett, gebogen, 16cm YASARGIL <i>micro-needleholder, bayonett, curved, 16cm</i>
<b>ZA-004-677</b>	YASARGIL Mikro-Nadelhalter, bayonett, gebogen, 18cm YASARGIL <i>micro-needleholder, bayonett, curved, 18cm</i>
<b>ZA-004-678</b>	YASARGIL Mikro-Nadelhalter, bayonett, gebogen, 20cm YASARGIL <i>micro-needleholder, bayonett, curved, 20cm</i>
<b>ZA-004-679</b>	YASARGIL Mikro-Nadelhalter, bayonett, gebogen, 22.5cm YASARGIL <i>micro-needleholder, bayonett, curved, 22.5cm</i>



LD-008-033



LD-008-025  
bis / to  
LD-008-028



LD-008-029  
bis / to  
LD-008-032



LD-008-020  
bis / to  
LD-008-023



LD-008-024

Bestell-Nr. Ordering no.	Bezeichnung Description
LD-008-020	BISHOP scharfer Löffel, Fig. 1, 16cm <i>BISHOP spoon sharp, fig. 1, 16cm</i>
LD-008-021	BISHOP scharfer Löffel, Fig. 2, 16cm <i>BISHOP spoon sharp, fig. 2, 16cm</i>
LD-008-022	BISHOP scharfer Löffel, Fig. 3, 16cm <i>BISHOP spoon sharp, fig. 3, 16cm</i>
LD-008-023	BISHOP scharfer Löffel, Fig. 4, 16cm <i>BISHOP spoon sharp, fig. 4, 16cm</i>
LD-008-024	WOLF scharfer Löffel, 16cm <i>WOLF spoon sharp, 16cm</i>
LD-008-025	Scharfer Löffel, Ø 3.6mm, 25cm <i>Sharp spoon, Ø 3.6mm, 25cm</i>
LD-008-026	Scharfer Löffel, Ø 4.4mm, 25cm <i>Sharp spoon, Ø 4.4mm, 25cm</i>
LD-008-027	Scharfer Löffel, Ø 5.2mm, 25cm <i>Sharp spoon, Ø 5.2mm, 25cm</i>
LD-008-028	Scharfer Löffel, Ø 6.0mm, 25cm <i>Sharp spoon, Ø 6.0mm, 25cm</i>
LD-008-029	Scharfer Löffel, gebogen, Ø 3.6mm, 25cm <i>Sharp spoon, curved, Ø 3.6mm, 25cm</i>
LD-008-030	Scharfer Löffel, gebogen, Ø 4.4mm, 25cm <i>Sharp spoon, curved, Ø 4.4mm, 25cm</i>
LD-008-031	Scharfer Löffel, gebogen, Ø 5.2mm, 25cm <i>Sharp spoon, curved, Ø 5.2mm, 25cm</i>
LD-008-032	Scharfer Löffel, gebogen, Ø 6.0mm, 25cm <i>Sharp spoon, curved, Ø 6.0mm, 25cm</i>
LD-008-033	SCHILLER Löffel rund, gerade, 26.5cm <i>SCHILLER spoon round, straight, 26.5cm</i>





**LD-008-046**  
bis / to  
**LD-008-055**



**LD-008-034**  
bis / to  
**LD-008-041**

<b>Bestell-Nr.</b> <b>Ordering no.</b>	<b>Bezeichnung</b> <b>Description</b>
<b>LD-008-034</b>	WILLIGER scharfer Löffel, rund, Fig. 00, 17cm <i>WILLIGER spoon sharp, round, fig. 00, 17cm</i>
<b>LD-008-035</b>	WILLIGER scharfer Löffel, rund, Fig. 0, 17cm <i>WILLIGER spoon sharp, round, fig. 0, 17cm</i>
<b>LD-008-036</b>	WILLIGER scharfer Löffel, rund, Fig. 1, 17cm <i>WILLIGER spoon sharp, round, fig. 1, 17cm</i>
<b>LD-008-037</b>	WILLIGER scharfer Löffel, rund, Fig. 2, 17cm <i>WILLIGER spoon sharp, round, fig. 2, 17cm</i>
<b>LD-008-038</b>	WILLIGER scharfer Löffel, oval, Fig. 00, 17cm <i>WILLIGER spoon sharp, oval, fig. 00, 17cm</i>
<b>LD-008-039</b>	WILLIGER scharfer Löffel, oval, Fig. 0, 17cm <i>WILLIGER spoon sharp, oval, fig. 0, 17cm</i>
<b>LD-008-040</b>	WILLIGER scharfer Löffel, oval, Fig. 1, 17cm <i>WILLIGER spoon sharp, oval, fig. 1, 17cm</i>
<b>LD-008-041</b>	WILLIGER scharfer Löffel, oval, Fig. 2, 17cm <i>WILLIGER spoon sharp, oval, fig. 2, 17cm</i>
<b>LD-008-046</b>	BRUNS scharfer Löffel, oval, Hartgewebegriff, Fig. 0000, 27cm <i>BRUNS spoon sharp, oval, plastic handle, fig. 0000, 27cm</i>
<b>LD-008-047</b>	BRUNS scharfer Löffel, oval, Hartgewebegriff, Fig. 000, 27cm <i>BRUNS spoon sharp, oval, plastic handle, fig. 000, 27cm</i>
<b>LD-008-048</b>	BRUNS scharfer Löffel, oval, Hartgewebegriff, Fig. 00, 27cm <i>BRUNS spoon sharp, oval, plastic handle, fig. 00, 27cm</i>
<b>LD-008-049</b>	BRUNS scharfer Löffel, oval, Hartgewebegriff, Fig. 0, 27cm <i>BRUNS spoon sharp, oval, plastic handle, fig. 0, 27cm</i>
<b>LD-008-050</b>	BRUNS scharfer Löffel, oval, Hartgewebegriff, Fig. 1, 27cm <i>BRUNS spoon sharp, oval, plastic handle, fig. 1, 27cm</i>
<b>LD-008-051</b>	BRUNS scharfer Löffel, oval, Hartgewebegriff, Fig. 2, 27cm <i>BRUNS spoon sharp, oval, plastic handle, fig. 2, 27cm</i>
<b>LD-008-052</b>	BRUNS scharfer Löffel, oval, Hartgewebegriff, Fig. 3, 27cm <i>BRUNS spoon sharp, oval, plastic handle, fig. 3, 27cm</i>
<b>LD-008-053</b>	BRUNS scharfer Löffel, oval, Hartgewebegriff, Fig. 4, 27cm <i>BRUNS spoon sharp, oval, plastic handle, fig. 4, 27cm</i>
<b>LD-008-054</b>	BRUNS scharfer Löffel, oval, Hartgewebegriff, Fig. 5, 27cm <i>BRUNS spoon sharp, oval, plastic handle, fig. 5, 27cm</i>
<b>LD-008-055</b>	BRUNS scharfer Löffel, oval, Hartgewebegriff, Fig. 6, 27cm <i>BRUNS spoon sharp, oval, plastic handle, fig. 6, 27cm</i>





**LD-008-062**  
bis / to  
**LD-008-067**



**LD-008-056**  
bis / to  
**LD-008-061**



**LD-008-042**  
bis / to  
**LD-008-045**

Bestell-Nr. Ordering no.	Bezeichnung Description
<b>LD-008-042</b>	DAUBENSPECK scharfer Löffel, oval, Fig. 00, 20cm <i>DAUBENSPECK spoon sharp, oval, fig. 00, 20cm</i>
<b>LD-008-043</b>	DAUBENSPECK scharfer Löffel, oval, Fig. 0, 20cm <i>DAUBENSPECK spoon sharp, oval, fig. 0, 20cm</i>
<b>LD-008-044</b>	DAUBENSPECK scharfer Löffel, oval, Fig. 1, 20cm <i>DAUBENSPECK spoon sharp, oval, fig. 1, 20cm</i>
<b>LD-008-045</b>	DAUBENSPECK scharfer Löffel, oval, Fig. 2, 20cm <i>DAUBENSPECK spoon sharp, oval, fig. 2, 20cm</i>
<b>LD-008-056</b>	SIMON scharfer Löffel, oval, fest, scharf, Fig. 1, 23cm <i>SIMON spoon sharp, oval, rigid, sharp, fig. 1, 23cm</i>
<b>LD-008-057</b>	SIMON scharfer Löffel, oval, fest, scharf, Fig. 2, 23cm <i>SIMON spoon sharp, oval, rigid, sharp, fig. 2, 23cm</i>
<b>LD-008-058</b>	SIMON scharfer Löffel, oval, fest, scharf, Fig. 3, 23cm <i>SIMON spoon sharp, oval, rigid, sharp, fig. 3, 23cm</i>
<b>LD-008-059</b>	SIMON scharfer Löffel, oval, fest, scharf, Fig. 4, 23cm <i>SIMON spoon sharp, oval, rigid, sharp, fig. 4, 23cm</i>
<b>LD-008-060</b>	SIMON scharfer Löffel, oval, fest, scharf, Fig. 5, 23cm <i>SIMON spoon sharp, oval, rigid, sharp, fig. 5, 23cm</i>
<b>LD-008-061</b>	SIMON scharfer Löffel, oval, fest, scharf, Fig. 6, 23cm <i>SIMON spoon sharp, oval, rigid, sharp, fig. 6, 23cm</i>
<b>LD-008-062</b>	SIMON scharfer Löffel, oval, fest, scharf, Fig. 1, 24cm <i>SIMON spoon sharp, oval, rigid, sharp, fig. 1, 24cm</i>
<b>LD-008-063</b>	SIMON scharfer Löffel, oval, fest, scharf, Fig. 2, 24cm <i>SIMON spoon sharp, oval, rigid, sharp, fig. 2, 24cm</i>
<b>LD-008-064</b>	SIMON scharfer Löffel, oval, fest, scharf, Fig. 3, 24cm <i>SIMON spoon sharp, oval, rigid, sharp, fig. 3, 24cm</i>
<b>LD-008-065</b>	SIMON scharfer Löffel, oval, fest, scharf, Fig. 4, 24cm <i>SIMON spoon sharp, oval, rigid, sharp, fig. 4, 24cm</i>
<b>LD-008-066</b>	SIMON scharfer Löffel, oval, fest, scharf, Fig. 5, 24cm <i>SIMON spoon sharp, oval, rigid, sharp, fig. 5, 24cm</i>
<b>LD-008-067</b>	SIMON scharfer Löffel, oval, fest, scharf, Fig. 6, 24cm <i>SIMON spoon sharp, oval, rigid, sharp, fig. 6, 24cm</i>



**ZA-002-599**  
bis / to  
**ZA-002-607**



**ZA-002-616**  
bis / to  
**ZA-002-622**

<b>Bestell-Nr.</b> <b>Ordering no.</b>	<b>Bezeichnung</b> <b>Description</b>
<b>ZA-002-599</b>	BRUNS Kürette, Fig. 000, 17cm <i>BRUNS curette, fig. 000, 17cm</i>
<b>ZA-002-600</b>	BRUNS Kürette, Fig. 00, 17cm <i>BRUNS curette, fig. 00, 17cm</i>
<b>ZA-002-601</b>	BRUNS Kürette, Fig. 0, 17cm <i>BRUNS curette, fig. 0, 17cm</i>
<b>ZA-002-602</b>	BRUNS Kürette, Fig. 1, 17cm <i>BRUNS curette, fig. 1, 17cm</i>
<b>ZA-002-603</b>	BRUNS Kürette, Fig. 2, 17cm <i>BRUNS curette, fig. 2, 17cm</i>
<b>ZA-002-604</b>	BRUNS Kürette, Fig. 3, 17cm <i>BRUNS curette, fig. 3, 17cm</i>
<b>ZA-002-605</b>	BRUNS Kürette, Fig. 4, 17cm <i>BRUNS curette, fig. 4, 17cm</i>
<b>ZA-002-606</b>	BRUNS Kürette, Fig. 5, 17cm <i>BRUNS curette, fig. 5, 17cm</i>
<b>ZA-002-607</b>	BRUNS Kürette, Fig. 6, 17cm <i>BRUNS curette, fig. 6, 17cm</i>
<b>ZA-002-616</b>	SCHEDE Knochenkürette, Fig. 000, 17cm <i>SCHEDE bone curette, fig. 000, 17cm</i>
<b>ZA-002-617</b>	SCHEDE Knochenkürette, Fig. 00, 17cm <i>SCHEDE bone curette, fig. 00, 17cm</i>
<b>ZA-002-618</b>	SCHEDE Knochenkürette, Fig. 0, 17cm <i>SCHEDE bone curette, fig. 0, 17cm</i>
<b>ZA-002-619</b>	SCHEDE Knochenkürette, Fig. 1, 17cm <i>SCHEDE bone curette, fig. 1, 17cm</i>
<b>ZA-002-620</b>	SCHEDE Knochenkürette, Fig. 2, 17cm <i>SCHEDE bone curette, fig. 2, 17cm</i>
<b>ZA-002-621</b>	SCHEDE Knochenkürette, Fig. 3, 17cm <i>SCHEDE bone curette, fig. 3, 17cm</i>
<b>ZA-002-622</b>	SCHEDE Knochenkürette, Fig. 4, 17cm <i>SCHEDE bone curette, fig. 4, 17cm</i>



**ZA-002-589**  
bis / to  
**ZA-002-598**

<b>Bestell-Nr. Ordering no.</b>	<b>Bezeichnung Description</b>
<b>ZA-002-589</b>	VOLKMANN Kürette, Fig. 0000, 17cm VOLKMANN curette, fig. 0000, 17cm
<b>ZA-002-590</b>	VOLKMANN Kürette, Fig. 000, 17cm VOLKMANN curette, fig. 000, 17cm
<b>ZA-002-591</b>	VOLKMANN Kürette, Fig. 00, 17cm VOLKMANN curette, fig. 00, 17cm
<b>ZA-002-592</b>	VOLKMANN Kürette, Fig. 0, 17cm VOLKMANN curette, fig. 0, 17cm
<b>ZA-002-593</b>	VOLKMANN Kürette, Fig. 1, 17cm VOLKMANN curette, fig. 1, 17cm
<b>ZA-002-594</b>	VOLKMANN Kürette, Fig. 2, 17cm VOLKMANN curette, fig. 2, 17cm
<b>ZA-002-595</b>	VOLKMANN Kürette, Fig. 3, 17cm VOLKMANN curette, fig. 3, 17cm
<b>ZA-002-596</b>	VOLKMANN Kürette, Fig. 4, 17cm VOLKMANN curette, fig. 4, 17cm
<b>ZA-002-597</b>	VOLKMANN Kürette, Fig. 5, 17cm VOLKMANN curette, fig. 5, 17cm
<b>ZA-002-598</b>	VOLKMANN Kürette, Fig. 6, 17cm VOLKMANN curette, fig. 6, 17cm



**LR-001-010**  
bis / to  
**LR-001-013**

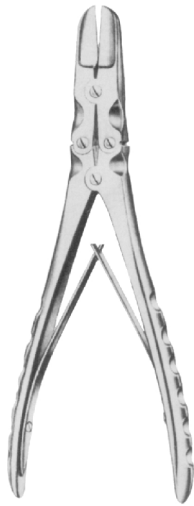

**LR-001-002 /**  
**LR-001-003**



**LR-001-014**  
bis / to  
**LR-001-017**



**LR-001-018**



**LR-001-019**

<b>Bestell-Nr.</b> <b>Ordering no.</b>	<b>Bezeichnung</b> <b>Description</b>
<b>LR-001-002</b>	RUSKIN-LISTON Knochensplitterzange, gerade, 18cm <i>RUSKIN-LISTON bone cutting forceps, straight, 18cm</i>
<b>LR-001-003</b>	RUSKIN-LISTON Knochensplitterzange, gebogen, 18cm <i>RUSKIN-LISTON bone cutting forceps, curved, 18cm</i>
<b>LR-001-010</b>	LEMPERT Hohlmeisselzange, gerade, 16cm <i>LEMPERT bone rongeur, straight, 16cm</i>
<b>LR-001-012</b>	LEMPERT Hohlmeisselzange, gerade, 19cm <i>LEMPERT bone rongeur, straight, 19cm</i>
<b>LR-001-011</b>	LEMPERT Hohlmeisselzange, gebogen, 16cm <i>LEMPERT bone rongeur, curved, 16cm</i>
<b>LR-001-013</b>	LEMPERT Hohlmeisselzange, gebogen, 19cm <i>LEMPERT bone rongeur, curved, 19cm</i>
<b>LR-001-014</b>	RUSKIN Hohlmeisselzange, gerade, 5mm, 18cm <i>RUSKIN bone rongeur, straight, 5mm, 18cm</i>
<b>LR-001-015</b>	RUSKIN Hohlmeisselzange, gerade, 6mm, 18cm <i>RUSKIN bone rongeur, straight, 6mm, 18cm</i>
<b>LR-001-016</b>	RUSKIN Hohlmeisselzange, gebogen, 5mm, 18cm <i>RUSKIN bone rongeur, curved, 5mm, 18cm</i>
<b>LR-001-017</b>	RUSKIN Hohlmeisselzange, gebogen, 6mm, 18cm <i>RUSKIN bone rongeur, curved, 6mm, 18cm</i>
<b>LR-001-018</b>	BEYER Hohlmeisselzange, gebogen, 18cm <i>BEYER bone rongeur, curved, 18cm</i>
<b>LR-001-019</b>	ZAUFAL-JANSEN Hohlmeisselzange, gebogen, 18cm <i>ZAUFAL-JANSEN bone rongeur, curved, 18cm</i>



ZA-004-325



ZA-002-703



ZA-004-326



LR-001-020



ZA-002-696

Bestell-Nr. Ordering no.	Bezeichnung Description
LR-001-020	JANSEN Hohlmeisselzange, bajonettförmig gebogen, 17cm <i>JANSEN bone rongeur, bayonett shaped curved, 17cm</i>
ZA-002-696	LUER Hohlmeisselzange, gebogen, 15cm <i>LUER bone rongeur, curved, 15cm</i>
ZA-002-703	BEYER Hohlmeisselzange, Doppelgelenk, gebogen, 18cm <i>BEYER bone rongeur, double joint, curved, 18cm</i>
ZA-004-325	LEMPERT Hohlmeisselzange, schlank, gerade, 19cm <i>LEMPERT bone rongeur, delicate, straight, 19cm</i>
ZA-004-326	BEYER Hohlmeisselzange, schlank, gebogen, 18cm <i>BEYER bone rongeur, delicate, curved, 18cm</i>



**LD-300-050**



**LD-300-051**



**LD-300-053**



**LD-300-054**



**LD-300-055**



**LD-300-056**



**LD-300-052**

<b>Bestell-Nr. Ordering no.</b>	<b>Bezeichnung Description</b>
<b>LD-300-050</b>	SANDERS-BROWN Ahle, gebogen, 30cm SANDERS-BROWN awl, curved, 30cm
<b>LD-300-051</b>	SANDERS-BROWN Ahle, gebogen, 29cm SANDERS-BROWN awl, curved, 29cm
<b>LD-300-052</b>	OBWEGESER Unterkieferahle, gebogen, 14cm OBWEGESER awl, curved, 14cm
<b>LD-300-053</b>	OBWEGESER Jochbogenahle, gebogen, 23cm OBWEGESER awl, curved, 23cm
<b>LD-300-054</b>	OBWEGESER Oberkieferahle, gebogen, 18cm OBWEGESER awl, curved, 18cm
<b>LD-300-055</b>	KELSEY-FRY Kieferahle, kurz, 15cm KELSEY-FRY awl, short, 15cm
<b>LD-300-056</b>	KELSEY-FRY Kieferahle, gebogen, 15cm KELSEY-FRY awl, curved, 15cm



**LD-300-001 /  
LD-300-002**



**LD-300-011**



**LD-300-012**



**LD-300-004  
bis / to  
LD-300-006**



**LD-300-015**



**LD-300-003**



**LD-300-007  
bis / to  
LD-300-010**

<b>Bestell-Nr. Ordering no.</b>	<b>Bezeichnung Description</b>
<b>LD-300-001</b>	OBWEGESER-FREER Elevator, doppelendig, Fig. 1, 21cm <i>OBWEGESER-FREER elevator, double ended, fig. 1, 21cm</i>
<b>LD-300-002</b>	OBWEGESER-FREER Elevator, doppelendig, Fig. 2, 21cm <i>OBWEGESER-FREER elevator, double ended, fig. 2, 21cm</i>
<b>LD-300-003</b>	OBWEGESER Schwalbenschwanz Raspatorium, 9mm, 17.5cm <i>OBWEGESER dovetail raspatory, 9mm, 17.5cm</i>
<b>LD-300-004</b>	OBWEGESER Raspatorium, gewinkelt, 5mm, 20cm <i>OBWEGESER raspatory, angled, 5mm, 20cm</i>
<b>LD-300-005</b>	OBWEGESER Raspatorium, gewinkelt, 7mm, 20cm <i>OBWEGESER raspatory, angled, 7mm, 20cm</i>
<b>LD-300-006</b>	OBWEGESER Raspatorium, gewinkelt, 9mm, 20cm <i>OBWEGESER raspatory, angled, 9mm, 20cm</i>
<b>LD-300-007</b>	OBWEGESER Raspatorium, flach, 6mm, 17.5cm <i>OBWEGESER raspatory, flat, 6mm, 17.5cm</i>
<b>LD-300-008</b>	OBWEGESER Raspatorium, flach, 7mm, 17.5cm <i>OBWEGESER raspatory, flat, 7mm, 17.5cm</i>
<b>LD-300-009</b>	OBWEGESER Raspatorium, flach, 9mm, 17.5cm <i>OBWEGESER raspatory, flat, 9mm, 17.5cm</i>
<b>LD-300-010</b>	OBWEGESER Raspatorium, flach, 11mm, 17.5cm <i>OBWEGESER raspatory, flat, 11mm, 17.5cm</i>
<b>LD-300-011</b>	GILLIES Elevator, gewinkelt, 21cm <i>GILLIES elevator, angled, 21cm</i>
<b>LD-300-012</b>	GILLIES Elevator, gewinkelt, 21cm <i>GILLIES elevator, angled, 21cm</i>
<b>LD-300-015</b>	DINGMANN Elevator, scharf/stump, 18cm <i>DINGMANN elevator, sharp/blunt, 18cm</i>





LD-300-100



LD-300-105 /  
LD-300-106



LD-300-101 /  
LD-300-102



LD-300-104



LD-300-103



LD-300-107 /  
LD-300-108



LD-300-013

Bestell-Nr. Ordering no.	Bezeichnung Description
LD-300-013	MERSHON Kronenschieber, 14.5cm <i>MERSHON pusher, 14.5cm</i>
LD-300-100	OBWEGESER Osteotom, gebogen, 10mm, 23.5cm <i>OBWEGESER osteotome, curved, 10mm, 23.5cm</i>
LD-300-101	TESSIER Osteotom, gerade, 10mm, 20.5cm <i>TESSIER osteotome, straight, 10mm, 20.5cm</i>
LD-300-102	TESSIER Osteotom, gebogen, 10mm, 20.5cm <i>TESSIER osteotome, curved, 10mm, 20.5cm</i>
LD-300-103	OBWEGESER Septumosteotom, U-förmig, 18.5cm <i>OBWEGESER septum osteotome, U-shape, 18.5cm</i>
LD-300-104	OBWEGESER Septumosteotom, V-förmig, 18.5cm <i>OBWEGESER septum osteotome, V-shape, 18.5cm</i>
LD-300-105	OBWEGESER Osteotom, 7mm, 21.5cm <i>OBWEGESER osteotome, 7mm, 21.5cm</i>
LD-300-106	OBWEGESER Osteotom, 10mm, 21.5cm <i>OBWEGESER osteotome, 10mm, 21.5cm</i>
LD-300-107	OBWEGESER Osteotom, fein, 2.5mm, 15cm <i>OBWEGESER osteotome, fine, 2.5mm, 15cm</i>
LD-300-108	OBWEGESER Osteotom, fein, 2.5mm, 15cm <i>OBWEGESER osteotome, fine, 2.5mm, 15cm</i>

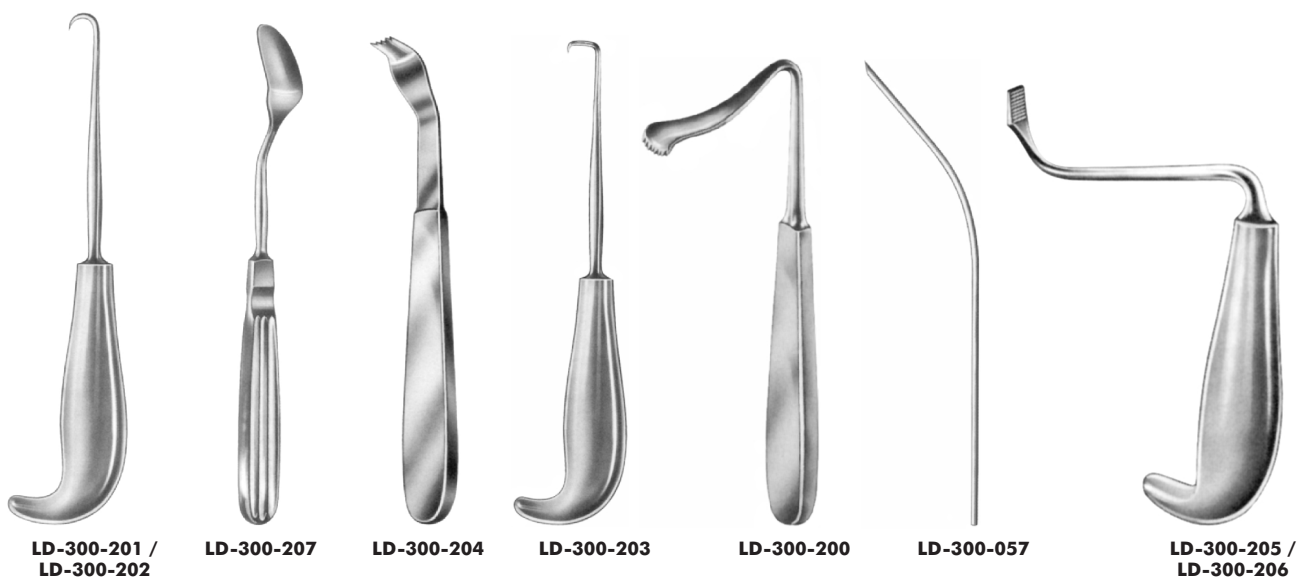

Bestell-Nr. Ordering no.	Bezeichnung Description
LD-300-057	DINGMAN Drahtumführer, gebogen, spitz <i>DINGMAN wire pusher, curved</i>
LD-300-200	BOWDLER-HENRY'S Wundhaken, 16cm <i>BOWDLER-HENRY'S retractor, 16cm</i>
LD-300-201	Jochbogenhaken, scharf, 10mm, 19cm <i>Retractor, sharp, 10mm, 19cm</i>
LD-300-202	Jochbogenhaken, scharf, 20mm, 19cm <i>Retractor, sharp, 20mm, 19cm</i>
LD-300-203	DINGMANN Jochbogenhaken, 10mm, 17cm <i>DINGMANN retractor, 10mm, 17cm</i>
LD-300-204	SÖRENSEN-HEIN Kieferhaken, gezahnt, 17.5cm <i>SÖRENSEN-HEIN retractor, toothed, 17.5cm</i>
LD-300-205	TESSIER Mobilisierungshaken, links, 15cm <i>TESSIER mobilisation retractor, left, 15cm</i>
LD-300-206	TESSIER Mobilisierungshaken, rechts, 15cm <i>TESSIER mobilisation retractor, right, 15cm</i>
LD-300-207	SINGEL Orbital Retraktor, 18.5cm <i>SINGEL orbital retractor, 18.5cm</i>



<b>Bestell-Nr. Ordering no.</b>	<b>Seite Page</b>	<b>Bestell-Nr. Ordering no.</b>	<b>Seite Page</b>	<b>Bestell-Nr. Ordering no.</b>	<b>Seite Page</b>	<b>Bestell-Nr. Ordering no.</b>	<b>Seite Page</b>
DA-001-000	212	GH-004-052	202	LA-001-004	11	LA-010-001	131
DA-001-001	212	GH-004-053	202	LA-001-004	129	LA-010-003	131
DA-003-000	212	GH-004-054	202	LA-001-005	11	LA-011-001	197
DA-003-001	212	GH-004-060	201	LA-001-005	129	LA-011-002	197
DC-001-000	212	GH-004-061	201	LA-001-006	11	LA-011-003	197
DC-001-001	212	GH-004-062	201	LA-001-006	129	LA-011-004	197
DC-003-000	212	GH-004-063	201	LA-002-001	12	LA-011-005	197
DC-003-001	212	GH-004-064	201	LA-002-001	130	LA-011-006	197
ES-008-001	12	GH-004-065	201	LA-002-002	12	LA-011-007	197
ES-008-001	130	GH-004-066	201	LA-002-002	130	LA-011-008	197
GD-005-001	210	GH-004-067	201	LA-002-003	12	LA-015-001	198
GD-005-002	210	GH-004-068	201	LA-002-003	130	LA-015-002	198
GD-005-003	210	GH-004-069	201	LA-002-004	12	LA-015-003	198
GD-005-004	210	GH-004-070	201	LA-002-004	130	LA-015-004	198
GD-005-005	210	GH-004-071	201	LA-002-005	12	LA-015-005	198
GD-005-010	211	GH-004-072	201	LA-002-005	130	LA-015-009	198
GD-005-011	211	GH-004-073	201	LA-002-006	12	LA-015-010	198
GD-005-012	211	GH-004-074	201	LA-002-006	130	LA-015-011	198
GD-005-013	211	GH-004-075	201	LA-002-007	12	LA-015-012	198
GD-010-001	209	GH-004-076	201	LA-002-007	130	LA-015-013	198
GD-010-002	209	GH-004-077	201	LA-002-008	12	LA-015-014	198
GD-010-003	209	GH-004-078	201	LA-002-008	130	LA-015-020	198
GD-010-004	209	GH-004-079	201	LA-002-009	12	LA-015-021	198
GD-010-005	209	GH-004-080	201	LA-002-009	130	LA-015-022	198
GD-010-006	209	GH-004-081	202	LA-002-010	12	LA-015-023	198
GD-010-007	209	GH-004-082	202	LA-002-010	130	LA-015-024	198
GD-010-008	209	GH-004-083	202	LA-002-011	12	LA-015-025	198
GD-010-009	209	GH-004-084	202	LA-002-011	130	LA-015-026	198
GD-010-010	209	GH-004-085	202	LA-002-012	12	LA-015-027	198
GH-004-001	202	GH-004-086	202	LA-002-012	130	LA-050-001	1
GH-004-002	202	GH-004-087	202	LA-002-013	12	LA-050-002	1
GH-004-003	202	GH-004-088	202	LA-002-013	130	LA-050-003	1
GH-004-004	202	GH-005-001	199	LA-002-014	12	LA-050-004	1
GH-004-005	202	GH-005-002	199	LA-002-014	130	LA-050-005	1
GH-004-006	202	GH-005-003	199	LA-002-015	12	LA-050-006	1
GH-004-007	202	GH-005-004	199	LA-002-015	130	LA-050-007	2
GH-004-010	199	GH-005-005	199	LA-002-016	12	LA-050-008	2
GH-004-011	199	GH-005-006	199	LA-003-001	11	LA-050-009	2
GH-004-012	199	GH-005-007	199	LA-003-001	129	LA-050-010	2
GH-004-015	199	GH-005-008	199	LA-003-002	11	LA-050-011	2
GH-004-020	200	GH-005-009	199	LA-003-002	129	LA-050-012	3
GH-004-021	200	GH-010-001	205	LA-003-003	11	LA-050-013	3
GH-004-022	200	GH-010-002	205	LA-003-003	129	LA-050-014	3
GH-004-023	200	GH-010-003	205	LA-004-001	11	LA-050-015	3
GH-004-025	200	LA-000-001	11	LA-004-001	129	LA-050-020	3
GH-004-026	200	LA-000-001	129	LA-004-002	11	LA-050-021	3
GH-004-027	200	LA-000-002	11	LA-004-002	129	LA-050-022	4
GH-004-028	200	LA-000-002	129	LA-005-001	11	LA-050-023	4
GH-004-029	200	LA-000-003	12	LA-005-001	129	LA-050-024	4
GH-004-030	200	LA-000-003	130	LA-005-002	11	LA-050-025	4
GH-004-031	200	LA-000-004	12	LA-005-002	129	LA-050-026	5
GH-004-032	200	LA-000-004	130	LA-006-001	11	LA-050-027	5
GH-004-033	200	LA-000-005	11	LA-006-001	129	LA-050-028	5
GH-004-034	200	LA-000-005	129	LA-006-002	11	LA-050-029	5
GH-004-035	200	LA-001-001	11	LA-006-002	129	LA-050-030	5
GH-004-036	200	LA-001-001	129	LA-007-001	11	LA-050-031	5
GH-004-037	200	LA-001-002	11	LA-007-001	129	LA-050-040	6
GH-004-038	200	LA-001-002	129	LA-007-002	11	LA-050-041	6
GH-004-050	202	LA-001-003	11	LA-007-002	129	LA-050-042	6
GH-004-051	202	LA-001-003	129	LA-010-000	131	LA-050-043	6

<b>Bestell-Nr.</b> <b>Ordering no.</b>	<b>Seite</b> <b>Page</b>	<b>Bestell-Nr.</b> <b>Ordering no.</b>	<b>Seite</b> <b>Page</b>	<b>Bestell-Nr.</b> <b>Ordering no.</b>	<b>Seite</b> <b>Page</b>	<b>Bestell-Nr.</b> <b>Ordering no.</b>	<b>Seite</b> <b>Page</b>
LA-050-050	6	LC-001-003-SS	159	LC-001-032-S	158	LC-002-014-S	158
LA-050-051	7	LC-001-004	153	LC-001-033	154	LC-002-004-SS	118
LA-050-060	7	LC-001-004-S	157	LC-001-033-S	158	LC-002-004-SS	161
LA-050-061	7	LC-001-004-SS	117	LC-001-033-SS	160	LC-002-005	155
LA-050-062	7	LC-001-004-SS	159	LC-001-034	154	LC-002-015-S	158
LA-050-065	8	LC-001-005	153	LC-001-034-S	158	LC-002-005-SS	118
LA-050-070	8	LC-001-005-S	157	LC-001-035	154	LC-002-005-SS	161
LA-050-071	8	LC-001-005-SS	117	LC-001-035-S	158	LC-002-006	155
LA-100-001	20	LC-001-005-SS	159	LC-001-035-SS	160	LC-002-016-S	158
LA-100-002	20	LC-001-006-SS	117	LC-001-041	154	LC-002-006-SS	118
LA-100-003	20	LC-001-006-SS	159	LC-001-041-S	158	LC-002-006-SS	161
LA-100-004	20	LC-001-007-SS	117	LC-001-041-SS	160	LC-002-011-SS	162
LA-100-005	20	LC-001-011	153	LC-001-042	154	LC-002-012-SS	162
LA-100-006	20	LC-001-011-S	157	LC-001-042-S	158	LC-002-013-SS	162
LA-100-007	20	LC-001-011-SS	117	LC-001-043	154	LC-002-014-SS	162
LA-100-008	20	LC-001-011-SS	159	LC-001-043-S	158	LC-002-015-SS	162
LA-100-009	20	LC-001-012	153	LC-001-043-SS	160	LC-002-016-SS	162
LA-100-010	20	LC-001-012-S	157	LC-001-044	154	LC-002-111-SS	118
LA-100-011	20	LC-001-012-SS	117	LC-001-044-S	158	LC-002-111-SS	161
LA-100-012	20	LC-001-012-SS	159	LC-001-045	154	LC-002-112-SS	118
LA-100-013	20	LC-001-013	153	LC-001-045-S	158	LC-002-112-SS	161
LB-001-001	134	LC-001-013-S	157	LC-001-051-SS	160	LC-002-113-SS	118
LB-001-002	134	LC-001-013-SS	117	LC-001-053-SS	160	LC-002-113-SS	161
LB-002-001	132	LC-001-013-SS	159	LC-001-061-SS	160	LC-002-114-SS	118
LB-002-002	132	LC-001-014	153	LC-001-063-SS	160	LC-002-114-SS	161
LB-002-003	132	LC-001-014-S	157	LC-001-065-SS	160	LC-002-115-SS	118
LB-002-004	132	LC-001-014-SS	117	LC-001-101-SS	162	LC-002-115-SS	161
LB-002-005	132	LC-001-014-SS	159	LC-001-102	153	LC-002-122-SS	118
LB-002-011	132	LC-001-015	153	LC-001-103	153	LC-002-122-SS	161
LB-002-012	132	LC-001-015-S	157	LC-001-103-SS	162	LC-002-123-SS	118
LB-002-013	132	LC-001-015-SS	117	LC-001-105-SS	162	LC-002-123-SS	161
LB-002-014	132	LC-001-015-SS	159	LC-001-111-SS	162	LC-002-124-SS	118
LB-002-015	132	LC-001-016-SS	117	LC-001-112	154	LC-002-124-SS	161
LB-002-020	133	LC-001-016-SS	159	LC-001-113	154	LC-002-201	163
LB-002-021	133	LC-001-017-SS	117	LC-001-113-SS	162	LC-002-202	163
LB-002-022	133	LC-001-017-SS	159	LC-001-114	154	LC-002-211	163
LB-002-023	133	LC-001-021	153	LC-001-115-SS	162	LC-002-212	163
LB-002-024	133	LC-001-021-S	157	LC-001-122	154	LC-003-001	155
LB-002-025	133	LC-001-022	153	LC-001-123	154	LC-003-001-SS	116
LB-002-026	133	LC-001-022-S	157	LC-001-123-SS	162	LC-003-001-SS	152
LB-005-001	132	LC-001-022-SS	117	LC-001-124	154	LC-003-002	155
LB-005-002	132	LC-001-022-SS	159	LC-001-133-SS	162	LC-003-002-SS	116
LB-005-003	132	LC-001-023	153	LC-001-200	155	LC-003-002-SS	152
LB-005-030	137	LC-001-023-S	157	LC-001-201	163	LC-003-003-SS	116
LB-005-031	137	LC-001-023-SS	117	LC-001-202	163	LC-003-003-SS	152
LB-005-032	137	LC-001-023-SS	159	LC-001-211	163	LC-003-011	155
LB-005-033	137	LC-001-024	153	LC-001-212	163	LC-003-011-SS	116
LB-005-034	137	LC-001-024-S	157	LC-002-001	155	LC-003-011-SS	152
LB-010-001	79	LC-001-024-SS	117	LC-002-011-S	158	LC-003-012	155
LC-001-001	153	LC-001-024-SS	159	LC-002-001-SS	118	LC-003-021-SS	116
LC-001-001-S	157	LC-001-025	153	LC-002-001-SS	161	LC-003-021-SS	152
LC-001-001-SS	117	LC-001-025-S	157	LC-002-002	155	LC-003-022-SS	116
LC-001-001-SS	159	LC-001-025-SS	117	LC-002-012-S	158	LC-003-022-SS	152
LC-001-002	153	LC-001-025-SS	159	LC-002-002-SS	118	LC-003-023-SS	116
LC-001-002-S	157	LC-001-026-SS	117	LC-002-002-SS	161	LC-003-023-SS	152
LC-001-002-SS	117	LC-001-026-SS	159	LC-002-003	155	LC-004-001	152
LC-001-002-SS	159	LC-001-031	154	LC-002-013-S	158	LC-004-001-SS	116
LC-001-003	153	LC-001-031-S	158	LC-002-003-SS	118	LC-004-001-SS	152
LC-001-003-S	157	LC-001-031-SS	160	LC-002-003-SS	161	LC-004-002-SS	116
LC-001-003-SS	117	LC-001-032	154	LC-002-004	155	LC-004-002-SS	152

Bestell-Nr. Ordering no.	Seite Page	Bestell-Nr. Ordering no.	Seite Page	Bestell-Nr. Ordering no.	Seite Page	Bestell-Nr. Ordering no.	Seite Page
LC-004-003-SS	116	LC-007-007	173	LC-007-070	69	LC-013-002	164
LC-004-003-SS	152	LC-007-008	124	LC-007-071	69	LC-013-003	164
LC-004-004-SS	116	LC-007-008	173	LC-007-072	69	LC-014-001	167
LC-004-004-SS	152	LC-007-009	124	LC-007-073	72	LC-014-002	167
LC-004-005	119	LC-007-009	173	LC-007-074	72	LC-014-003	167
LC-004-005-SS	116	LC-007-010	69	LC-007-075	72	LC-014-011	167
LC-004-005-SS	152	LC-007-011	69	LC-007-080	125	LC-014-012	167
LC-004-006	119	LC-007-012	69	LC-007-081	125	LC-014-013	167
LC-004-007	119	LC-007-013	69	LC-007-082	125	LC-014-021	167
LC-005-001	152	LC-007-014	69	LC-007-083	125	LC-014-022	167
LC-005-001-SS	116	LC-007-014	72	LC-007-084	124	LC-014-023	167
LC-005-001-SS	152	LC-007-014-1	72	LC-007-085	124	LC-014-031	167
LC-005-002	152	LC-007-015	69	LC-007-086	125	LC-014-032	167
LC-005-002-SS	116	LC-007-016	124	LC-007-100	72	LC-014-033	167
LC-005-002-SS	152	LC-007-016	173	LC-007-101	72	LC-014-036	167
LC-005-003	152	LC-007-017	124	LC-007-102	72	LC-014-037	167
LC-005-003-SS	116	LC-007-017	173	LC-007-103	72	LC-015-001	173
LC-005-003-SS	152	LC-007-020	173	LC-007-104	72	LC-015-002	173
LC-005-004-SS	116	LC-007-021	125	LC-007-105	72	LC-015-003	173
LC-005-004-SS	152	LC-007-022	173	LC-007-106	72	LC-016-001	170
LC-006-001	168	LC-007-030	69	LC-007-107	72	LC-016-002	170
LC-006-002	168	LC-007-031	69	LC-007-108	72	LC-016-011	170
LC-006-003	168	LC-007-032	69	LC-007-109	72	LC-016-012	170
LC-006-004	168	LC-007-033	69	LC-007-110	72	LC-017-001	171
LC-006-005	168	LC-007-034	70	LC-007-111	72	LC-017-002	172
LC-006-011	168	LC-007-035	70	LC-007-112	72	LC-017-003	172
LC-006-012	168	LC-007-036	70	LC-008-001	165	LC-017-004	172
LC-006-013	168	LC-007-037	70	LC-008-002	165	LC-017-005	172
LC-006-014	168	LC-007-038	70	LC-008-011	165	LC-017-006	172
LC-006-015	168	LC-007-039	70	LC-008-012	165	LC-017-007	172
LC-006-021	168	LC-007-040	70	LC-008-021	165	LC-017-008	172
LC-006-022	168	LC-007-041	70	LC-008-022	165	LC-017-009	172
LC-006-023	168	LC-007-042	70	LC-008-031	165	LC-017-010	170
LC-006-024	168	LC-007-043	70	LC-008-032	165	LC-017-011	171
LC-006-025	168	LC-007-044	70	LC-008-041	165	LC-017-012	171
LC-006-041	169	LC-007-045	70	LC-008-042	165	LC-017-013	171
LC-006-042	169	LC-007-046	70	LC-008-051	165	LC-017-014	171
LC-006-043	169	LC-007-047	70	LC-008-052	165	LC-017-015	171
LC-006-050	170	LC-007-048	70	LC-008-061	165	LC-017-016	171
LC-006-051	170	LC-007-049	70	LC-008-102	166	LC-017-017	171
LC-006-052	170	LC-007-050	71	LC-008-111	166	LC-017-018	171
LC-006-060	164	LC-007-051	71	LC-008-121	166	LC-017-019	171
LC-006-061	164	LC-007-052	71	LC-008-122	166	LC-017-020	171
LC-006-062	164	LC-007-053	71	LC-008-141	166	LC-017-021	170
LC-006-063	164	LC-007-054	71	LC-008-142	166	LC-017-030	171
LC-006-101	168	LC-007-055	71	LC-008-161	166	LC-017-031	171
LC-006-102	168	LC-007-056	71	LC-008-241	166	LC-017-032	171
LC-006-103	168	LC-007-057	71	LC-009-001	166	LC-018-001-SS	161
LC-007-001	124	LC-007-058	71	LC-009-002	166	LC-018-002	156
LC-007-001-SS	173	LC-007-059	71	LC-009-011	166	LC-018-002-SS	119
LC-007-002	124	LC-007-060	71	LC-009-012	166	LC-018-003	156
LC-007-002-SS	173	LC-007-061	71	LC-009-021	166	LC-018-004	156
LC-007-003	124	LC-007-062	71	LC-009-022	166	LC-018-005	156
LC-007-003-SS	173	LC-007-063	71	LC-010-001	155	LC-018-011-SS	162
LC-007-004	124	LC-007-064	71	LC-010-002	155	LC-018-012-SS	162
LC-007-005	124	LC-007-065	71	LC-010-003	155	LC-018-101	156
LC-007-005	173	LC-007-066	69	LC-011-001	164	LC-018-102	156
LC-007-006	124	LC-007-067	69	LC-011-002	164	LC-019-001	164
LC-007-006	173	LC-007-068	69	LC-012-001	164	LC-019-002	164
LC-007-007	124	LC-007-069	69	LC-013-001	164	LC-019-003	164

<b>Bestell-Nr.</b> <b>Ordering no.</b>	<b>Seite</b> <b>Page</b>	<b>Bestell-Nr.</b> <b>Ordering no.</b>	<b>Seite</b> <b>Page</b>	<b>Bestell-Nr.</b> <b>Ordering no.</b>	<b>Seite</b> <b>Page</b>	<b>Bestell-Nr.</b> <b>Ordering no.</b>	<b>Seite</b> <b>Page</b>
LC-019-004	164	LC-060-034	58	LC-060-095	61	LC-060-163	64
LC-019-005	164	LC-060-035	58	LC-060-096	61	LC-060-164	64
LC-019-010	156	LC-060-036	58	LC-060-097	61	LC-060-165	64
LC-019-011	156	LC-060-037	59	LC-060-098	61	LC-060-166	64
LC-019-012	156	LC-060-038	59	LC-060-099	61	LC-060-167	64
LC-019-018	156	LC-060-039	59	LC-060-105	60	LC-060-168	64
LC-019-020	164	LC-060-040	59	LC-060-106	60	LC-060-169	64
LC-019-021	164	LC-060-041	59	LC-060-107	60	LC-060-180	65
LC-019-022	164	LC-060-042	59	LC-060-108	60	LC-060-181	65
LC-019-023	164	LC-060-043	59	LC-060-110	62	LC-060-182	65
LC-020-001	168	LC-060-044	59	LC-060-111	62	LC-060-183	65
LC-020-002	168	LC-060-045	59	LC-060-112	62	LC-060-184	65
LC-020-010	120	LC-060-046	59	LC-060-113	62	LC-060-185	65
LC-020-011	120	LC-060-047	59	LC-060-114	62	LC-060-186	65
LC-020-015	122	LC-060-048	59	LC-060-115	62	LC-060-187	65
LC-020-016	122	LC-060-049	59	LC-060-116	62	LC-060-188	65
LC-020-017	119	LC-060-050	59	LC-060-117	62	LC-060-189	65
LC-020-019	119	LC-060-051	59	LC-060-118	62	LC-060-190	65
LC-020-020	57	LC-060-052	59	LC-060-119	62	LC-060-191	65
LC-020-021	57	LC-060-053	59	LC-060-120	62	LC-060-192	65
LC-020-022	58	LC-060-054	59	LC-060-121	62	LC-060-193	65
LC-020-023	58	LC-060-055	59	LC-060-122	62	LC-060-194	65
LC-020-024	57	LC-060-056	59	LC-060-123	62	LC-060-195	65
LC-020-025	57	LC-060-057	60	LC-060-124	62	LC-060-196	65
LC-020-026	57	LC-060-058	60	LC-060-125	62	LC-060-197	65
LC-020-027	57	LC-060-059	60	LC-060-126	62	LC-060-198	65
LC-020-028	57	LC-060-060	60	LC-060-127	62	LC-060-199	65
LC-020-029	57	LC-060-061	60	LC-060-128	62	LC-060-200	57
LC-020-030	120	LC-060-062	60	LC-060-129	62	LC-060-202	57
LC-020-031	120	LC-060-063	60	LC-060-130	62	LC-060-210	75
LC-020-032	120	LC-060-064	60	LC-060-131	62	LC-060-211	75
LC-020-033	120	LC-060-065	60	LC-060-132	62	LC-060-220	63
LC-020-034	120	LC-060-066	60	LC-060-133	62	LC-060-221	63
LC-020-035	122	LC-060-067	60	LC-060-134	63	LC-060-222	63
LC-020-036	122	LC-060-068	60	LC-060-135	63	LC-060-223	74
LC-020-037	125	LC-060-069	60	LC-060-136	63	LC-060-224	74
LC-020-038	125	LC-060-070	60	LC-060-137	63	LC-070-001	66
LC-030-001	115	LC-060-071	60	LC-060-138	63	LC-070-002	66
LC-030-001-1	56	LC-060-072	60	LC-060-139	63	LC-070-003	66
LC-030-001-2	56	LC-060-073	60	LC-060-140	63	LC-070-004	66
LC-030-002	115	LC-060-074	60	LC-060-141	63	LC-070-005	66
LC-030-003	115	LC-060-075	61	LC-060-142	63	LC-070-006	66
LC-030-004	115	LC-060-076	61	LC-060-143	63	LC-070-007	66
LC-040-001	58	LC-060-077	61	LC-060-144	63	LC-070-008	66
LC-040-002	58	LC-060-078	61	LC-060-145	63	LC-070-009	66
LC-060-001	58	LC-060-079	61	LC-060-146	63	LC-070-010	66
LC-060-020	58	LC-060-080	61	LC-060-147	63	LC-070-011	66
LC-060-021	58	LC-060-081	61	LC-060-150	64	LC-070-012	66
LC-060-022	58	LC-060-082	61	LC-060-151	64	LC-070-013	66
LC-060-023	58	LC-060-083	61	LC-060-152	64	LC-070-014	66
LC-060-024	58	LC-060-084	61	LC-060-153	64	LC-070-015	66
LC-060-025	58	LC-060-085	61	LC-060-154	64	LC-070-016	66
LC-060-026	58	LC-060-087	61	LC-060-155	64	LC-070-017	66
LC-060-027	58	LC-060-088	61	LC-060-156	64	LC-070-020	67
LC-060-028	58	LC-060-089	61	LC-060-157	64	LC-070-021	67
LC-060-029	58	LC-060-090	61	LC-060-158	64	LC-070-022	67
LC-060-030	58	LC-060-091	61	LC-060-159	64	LC-070-023	67
LC-060-031	58	LC-060-092	61	LC-060-160	64	LC-070-024	67
LC-060-032	58	LC-060-093	61	LC-060-161	64	LC-070-025	67
LC-060-033	58	LC-060-094	61	LC-060-162	64	LC-070-026	67



Bestell-Nr. Ordering no.	Seite Page	Bestell-Nr. Ordering no.	Seite Page	Bestell-Nr. Ordering no.	Seite Page	Bestell-Nr. Ordering no.	Seite Page
LC-070-027	67	LD-001-017	135	LD-001-095	46	LD-001-153	97
LC-070-028	67	LD-001-018	135	LD-001-095	138	LD-001-154	97
LC-070-029	67	LD-001-019	135	LD-001-096	46	LD-001-155	97
LC-070-030	67	LD-001-020	135	LD-001-096	96	LD-001-156	97
LC-070-031	67	LD-001-021	135	LD-001-097	96	LD-001-157	101
LC-070-032	67	LD-001-022	135	LD-001-097-1	96	LD-001-158	97
LC-070-033	67	LD-001-023	135	LD-001-098	96	LD-001-159	97
LC-070-034	67	LD-001-024	135	LD-001-099	96	LD-001-160	97
LC-070-035	67	LD-001-025	135	LD-001-100	87	LD-001-161	97
LC-070-036	68	LD-001-026	135	LD-001-101	136	LD-001-162	97
LC-070-037	68	LD-001-027	135	LD-001-102	136	LD-001-163	139
LC-070-038	68	LD-001-028	135	LD-001-103	87	LD-001-164	97
LC-070-039	68	LD-001-029	96	LD-001-104	87	LD-001-165	138
LC-070-040	68	LD-001-030	137	LD-001-105	87	LD-001-166	138
LC-070-041	68	LD-001-031	137	LD-001-106	87	LD-001-167	138
LC-070-042	68	LD-001-032	137	LD-001-107	87	LD-001-168	138
LC-070-043	68	LD-001-035	139	LD-001-108	87	LD-001-169	138
LC-070-044	68	LD-001-036	139	LD-001-109	87	LD-001-170	29
LC-070-045	68	LD-001-037	139	LD-001-110	87	LD-001-171	29
LC-070-046	68	LD-001-038	135	LD-001-111	88	LD-001-172	29
LC-070-047	68	LD-001-039	136	LD-001-112	88	LD-001-173	88
LC-080-001	75	LD-001-039-1	136	LD-001-113	88	LD-001-174	88
LC-080-002	75	LD-001-039-2	136	LD-001-114	88	LD-001-179	40
LC-080-003	75	LD-001-040	102	LD-001-115	88	LD-001-180	40
LC-080-004	75	LD-001-041	187	LD-001-116	86	LD-001-181	40
LC-080-005	75	LD-001-042	102	LD-001-117	88	LD-001-182	40
LC-080-006	75	LD-001-043	102	LD-001-118	88	LD-001-183	40
LC-080-007	75	LD-001-045	136	LD-001-120	99	LD-001-184	40
LC-080-008	75	LD-001-046	136	LD-001-121	99	LD-001-185	40
LC-080-009	75	LD-001-047	136	LD-001-122	99	LD-001-186	40
LC-080-010	75	LD-001-050	98	LD-001-123	99	LD-001-187	40
LC-080-011	75	LD-001-051	98	LD-001-124	99	LD-001-188	29
LC-080-012	75	LD-001-052	98	LD-001-125	99	LD-001-189	39
LC-080-013	75	LD-001-053	98	LD-001-126	99	LD-001-190	39
LC-080-014	75	LD-001-054	98	LD-001-127	99	LD-001-191	135
LC-080-015	75	LD-001-055	98	LD-001-128	99	LD-001-197	29
LC-080-016	75	LD-001-056	98	LD-001-129	99	LD-001-197-1	29
LC-080-020	75	LD-001-057	98	LD-001-130	99	LD-001-200	39
LC-080-021	75	LD-001-058	98	LD-001-131	99	LD-001-201	39
LC-080-022	75	LD-001-059	98	LD-001-132	99	LD-001-202	39
LC-080-030	75	LD-001-060	96	LD-001-133	99	LD-001-203	39
LC-080-031	75	LD-001-061	98	LD-001-134	99	LD-001-204	39
LC-080-032	75	LD-001-062	98	LD-001-135	99	LD-001-205	39
LC-080-040	75	LD-001-063	98	LD-001-136	100	LD-001-206	91
LD-001-001	95	LD-001-064	98	LD-001-137	100	LD-001-207	91
LD-001-002	95	LD-001-065	98	LD-001-138	100	LD-001-208	91
LD-001-003	95	LD-001-066	98	LD-001-139	100	LD-001-209	91
LD-001-004	95	LD-001-067	96	LD-001-140	100	LD-001-210	91
LD-001-005	95	LD-001-068	96	LD-001-141	100	LD-001-211	91
LD-001-006	95	LD-001-069	96	LD-001-142	100	LD-001-212	91
LD-001-007	95	LD-001-070	134	LD-001-143	100	LD-001-213	91
LD-001-008	95	LD-001-071	134	LD-001-144	100	LD-001-214	91
LD-001-009	95	LD-001-073	40	LD-001-145	100	LD-002-001	103
LD-001-010	95	LD-001-080	134	LD-001-146	101	LD-002-002	103
LD-001-011	95	LD-001-090	96	LD-001-147	101	LD-002-003	103
LD-001-012	137	LD-001-091	46	LD-001-148	101	LD-002-004	103
LD-001-013	137	LD-001-092	46	LD-001-149	101	LD-002-010	103
LD-001-014	135	LD-001-093	46	LD-001-150	96	LD-002-011	103
LD-001-015	135	LD-001-093	138	LD-001-151	96	LD-002-012	103
LD-001-016	135	LD-001-094	138	LD-001-152	101	LD-002-013	103

Bestell-Nr. Ordering no.	Seite Page	Bestell-Nr. Ordering no.	Seite Page	Bestell-Nr. Ordering no.	Seite Page	Bestell-Nr. Ordering no.	Seite Page
LD-002-014	103	LD-002-097	109	LD-002-157	109	LD-002-334	111
LD-002-015	103	LD-002-098	109	LD-002-158	109	LD-002-335	112
LD-002-016	103	LD-002-099	109	LD-002-159	109	LD-002-336	112
LD-002-017	103	LD-002-100	55	LD-002-160	107	LD-002-337	112
LD-002-020	54	LD-002-100	114	LD-002-161	107	LD-002-340	112
LD-002-021	54	LD-002-101	55	LD-002-162	107	LD-002-341	112
LD-002-022	54	LD-002-102	55	LD-002-163	107	LD-002-342	112
LD-002-023	54	LD-002-102	114	LD-002-164	107	LD-002-343	112
LD-002-025	53	LD-002-103	55	LD-002-165	76	LD-002-344	107
LD-002-026	53	LD-002-103	114	LD-002-200	46	LD-002-345	112
LD-002-027	53	LD-002-104	55	LD-002-201	46	LD-002-346	112
LD-002-028	53	LD-002-105	74	LD-002-202	46	LD-002-347	112
LD-002-029	53	LD-002-106	74	LD-002-203	46	LD-002-348	112
LD-002-035	104	LD-002-110	109	LD-002-205	46	LD-002-350	107
LD-002-036	104	LD-002-111	109	LD-002-206	46	LD-002-351	112
LD-002-037	104	LD-002-112	109	LD-002-207	47	LD-002-352	112
LD-002-038	104	LD-002-113	109	LD-002-210	47	LD-002-353	112
LD-002-040	54	LD-002-114	106	LD-002-211	47	LD-002-354	113
LD-002-041	54	LD-002-115	105	LD-002-212	47	LD-002-355	113
LD-002-042	54	LD-002-116	105	LD-002-213	47	LD-002-356	113
LD-002-043	54	LD-002-117	105	LD-002-214	47	LD-002-357	113
LD-002-044	53	LD-002-118	105	LD-002-215	47	LD-002-358	113
LD-002-045	53	LD-002-119	105	LD-002-216	47	LD-002-359	113
LD-002-046	53	LD-002-120	105	LD-002-217	47	LD-002-360	113
LD-002-047	53	LD-002-121	105	LD-002-218	47	LD-002-361	113
LD-002-049	53	LD-002-122	105	LD-002-219	139	LD-002-365	139
LD-002-050	53	LD-002-123	105	LD-002-300	103	LD-002-366	139
LD-002-060	74	LD-002-124	105	LD-002-301	110	LD-002-367	139
LD-002-061	74	LD-002-125	106	LD-002-302	110	LD-002-368	139
LD-002-062	74	LD-002-126	106	LD-002-303	110	LD-002-370	113
LD-002-063	74	LD-002-127	106	LD-002-304	110	LD-002-371	113
LD-002-064	74	LD-002-128	106	LD-002-305	110	LD-002-372	113
LD-002-065	74	LD-002-129	106	LD-002-306	110	LD-002-373	53
LD-002-070	104	LD-002-130	106	LD-002-307	110	LD-002-374	53
LD-002-071	104	LD-002-131	106	LD-002-308	110	LD-002-375	54
LD-002-072	106	LD-002-132	106	LD-002-309	110	LD-002-376	54
LD-002-073	106	LD-002-133	106	LD-002-310	110	LD-002-377	107
LD-002-074	106	LD-002-134	106	LD-002-311	110	LD-002-378	107
LD-002-075	108	LD-002-135	109	LD-002-312	110	LD-002-379	107
LD-002-076	108	LD-002-136	109	LD-002-313	110	LD-003-001	35
LD-002-077	108	LD-002-137	109	LD-002-314	110	LD-003-001-1	35
LD-002-078	108	LD-002-138	109	LD-002-315	110	LD-003-002	35
LD-002-079	108	LD-002-139	109	LD-002-316	110	LD-003-002-1	35
LD-002-080	108	LD-002-140	105	LD-002-317	111	LD-003-003	45
LD-002-081	108	LD-002-141	105	LD-002-318	111	LD-003-003	137
LD-002-082	108	LD-002-142	105	LD-002-319	111	LD-003-004	45
LD-002-083	108	LD-002-143	105	LD-002-320	111	LD-003-009	45
LD-002-084	108	LD-002-144	105	LD-002-321	111	LD-003-009-1	45
LD-002-085	104	LD-002-145	107	LD-002-322	111	LD-003-010	45
LD-002-086	104	LD-002-146	107	LD-002-323	111	LD-003-010-1	45
LD-002-087	104	LD-002-147	107	LD-002-324	111	LD-003-011	40
LD-002-088	104	LD-002-148	107	LD-002-325	111	LD-003-012	41
LD-002-089	104	LD-002-149	107	LD-002-326	111	LD-003-013	36
LD-002-090	108	LD-002-150	76	LD-002-327	111	LD-003-014	30
LD-002-091	108	LD-002-151	76	LD-002-328	111	LD-003-015	30
LD-002-092	108	LD-002-152	76	LD-002-329	111	LD-003-016	39
LD-002-093	108	LD-002-153	76	LD-002-330	111	LD-003-016-1	39
LD-002-094	108	LD-002-154	76	LD-002-331	111	LD-003-017	30
LD-002-095	108	LD-002-155	109	LD-002-332	111	LD-003-018	30
LD-002-096	108	LD-002-156	109	LD-002-333	111	LD-003-019	41

<b>Bestell-Nr. Ordering no.</b>	<b>Seite Page</b>	<b>Bestell-Nr. Ordering no.</b>	<b>Seite Page</b>	<b>Bestell-Nr. Ordering no.</b>	<b>Seite Page</b>	<b>Bestell-Nr. Ordering no.</b>	<b>Seite Page</b>
LD-003-020	41	LD-003-082	42	LD-003-172	90	LD-003-253	44
LD-003-021	41	LD-003-083	30	LD-003-173	90	LD-003-253	93
LD-003-022	28	LD-003-084	30	LD-003-174	90	LD-003-254	93
LD-003-022	41	LD-003-085	30	LD-003-175	44	LD-003-255	93
LD-003-023	28	LD-003-086	30	LD-003-175	90	LD-003-256	93
LD-003-024	28	LD-003-087	30	LD-003-176	44	LD-003-301	45
LD-003-025	28	LD-003-089	30	LD-003-177	44	LD-003-302	45
LD-003-026	28	LD-003-090	30	LD-003-178	44	LD-003-303	45
LD-003-027	39	LD-003-091	30	LD-003-194	45	LD-003-304	45
LD-003-028	29	LD-003-092	30	LD-003-200	36	LD-003-400	31
LD-003-029	30	LD-003-093	30	LD-003-201	36	LD-003-401	31
LD-003-030	43	LD-003-100	33	LD-003-202	36	LD-003-402	31
LD-003-031	43	LD-003-101	33	LD-003-203	36	LD-003-403	31
LD-003-031-1	43	LD-003-102	33	LD-003-204	36	LD-003-404	31
LD-003-032	43	LD-003-103	33	LD-003-204	45	LD-003-405	31
LD-003-033	43	LD-003-104	33	LD-003-205	37	LD-003-406	31
LD-003-033-1	43	LD-003-105	33	LD-003-206	37	LD-003-407	31
LD-003-034	43	LD-003-106	33	LD-003-207	37	LD-003-408	31
LD-003-037	30	LD-003-107	33	LD-003-208	37	LD-003-409	31
LD-003-038	30	LD-003-108	33	LD-003-209	37	LD-003-410	31
LD-003-039	30	LD-003-109	33	LD-003-210	37	LD-003-411	31
LD-003-040	30	LD-003-110	33	LD-003-211	37	LD-003-412	31
LD-003-041	30	LD-003-111	33	LD-003-212	37	LD-003-413	31
LD-003-042	30	LD-003-112	33	LD-003-215	36	LD-003-414	31
LD-003-043	30	LD-003-113	33	LD-003-216	42	LD-003-415	31
LD-003-044	30	LD-003-114	33	LD-003-218	42	LD-003-416	31
LD-003-045	30	LD-003-115	33	LD-003-219	40	LD-003-417	31
LD-003-046	30	LD-003-116	34	LD-003-220	42	LD-003-418	31
LD-003-047	29	LD-003-117	34	LD-003-221	42	LD-003-425	38
LD-003-048	29	LD-003-118	34	LD-003-222	42	LD-003-426	38
LD-003-049	29	LD-003-119	34	LD-003-223	42	LD-003-427	38
LD-003-050	89	LD-003-120	34	LD-003-224	42	LD-003-428	38
LD-003-051	28	LD-003-121	34	LD-003-225	92	LD-003-429	38
LD-003-052	28	LD-003-122	34	LD-003-226	92	LD-003-430	38
LD-003-053	28	LD-003-123	34	LD-003-227	92	LD-003-431	38
LD-003-054	28	LD-003-124	34	LD-003-228	92	LD-003-432	38
LD-003-059	28	LD-003-125	34	LD-003-229	92	LD-004-001	47
LD-003-060	28	LD-003-126	34	LD-003-230	92	LD-004-002	39
LD-003-061	28	LD-003-127	34	LD-003-231	92	LD-004-003	47
LD-003-062	89	LD-003-128	34	LD-003-232	92	LD-004-200	45
LD-003-063	89	LD-003-129	34	LD-003-233	92	LD-004-201	47
LD-003-064	89	LD-003-130	34	LD-003-234	92	LD-004-202	47
LD-003-065	89	LD-003-131	34	LD-003-235	92	LD-004-260	215
LD-003-066	89	LD-003-140	39	LD-003-236	92	LD-005-001	27
LD-003-067	89	LD-003-150	89	LD-003-237	92	LD-005-002	27
LD-003-068	89	LD-003-151	89	LD-003-238	92	LD-005-003	27
LD-003-069	28	LD-003-152	89	LD-003-239	93	LD-005-005	26
LD-003-070	43	LD-003-153	89	LD-003-240	93	LD-005-006	26
LD-003-071	43	LD-003-154	89	LD-003-241	93	LD-005-007	26
LD-003-072	43	LD-003-155	89	LD-003-242	93	LD-005-007	86
LD-003-073	43	LD-003-156	89	LD-003-243	93	LD-005-008	26
LD-003-074	43	LD-003-157	89	LD-003-244	93	LD-005-009	26
LD-003-075	43	LD-003-158	90	LD-003-245	93	LD-005-010	26
LD-003-076	43	LD-003-159	90	LD-003-246	93	LD-005-011	26
LD-003-077	41	LD-003-160	90	LD-003-250	44	LD-005-012	26
LD-003-078	41	LD-003-166	43	LD-003-250	93	LD-005-013	26
LD-003-079	41	LD-003-167	43	LD-003-251	44	LD-005-014	26
LD-003-080	41	LD-003-168	43	LD-003-251	93	LD-005-015	26
LD-003-080-1	41	LD-003-170	90	LD-003-252	44	LD-005-016	26
LD-003-081	42	LD-003-171	90	LD-003-252	93	LD-005-017	26

<b>Bestell-Nr. Ordering no.</b>	<b>Seite Page</b>	<b>Bestell-Nr. Ordering no.</b>	<b>Seite Page</b>	<b>Bestell-Nr. Ordering no.</b>	<b>Seite Page</b>	<b>Bestell-Nr. Ordering no.</b>	<b>Seite Page</b>
LD-005-018	26	LD-008-031	269	LD-020-026	184	LD-100-004	187
LD-005-018	86	LD-008-032	269	LD-020-027	184	LD-100-005	187
LD-005-019	26	LD-008-033	269	LD-020-030	191	LD-100-006	186
LD-005-019	86	LD-008-034	270	LD-020-031	191	LD-100-007	186
LD-005-020	26	LD-008-035	270	LD-020-032	191	LD-100-008	185
LD-005-021	205	LD-008-036	270	LD-020-033	191	LD-100-009	185
LD-005-022	26	LD-008-037	270	LD-020-034	191	LD-100-030	186
LD-005-023	26	LD-008-038	270	LD-020-035	194	LD-100-031	186
LD-005-024	86	LD-008-039	270	LD-020-036	194	LD-100-032	186
LD-005-025	86	LD-008-040	270	LD-020-037	194	LD-100-033	186
LD-006-001	32	LD-008-041	270	LD-020-038	194	LD-100-034	186
LD-006-002	32	LD-008-042	271	LD-020-039	194	LD-100-035	186
LD-006-003	32	LD-008-043	271	LD-020-040	194	LD-100-050	185
LD-006-004	32	LD-008-044	271	LD-020-041	194	LD-100-051	185
LD-006-005	32	LD-008-045	271	LD-020-042	194	LD-100-052	185
LD-006-006	32	LD-008-046	270	LD-020-043	194	LD-100-053	185
LD-006-007	32	LD-008-047	270	LD-020-044	194	LD-100-054	185
LD-006-008	32	LD-008-048	270	LD-020-045	194	LD-200-001	184
LD-006-009	32	LD-008-049	270	LD-020-046	194	LD-200-002	184
LD-006-010	32	LD-008-050	270	LD-020-047	194	LD-200-003	184
LD-006-011	32	LD-008-051	270	LD-020-048	194	LD-200-004	184
LD-006-015	32	LD-008-052	270	LD-020-049	194	LD-200-101	206
LD-006-016	32	LD-008-053	270	LD-020-050	194	LD-200-102	206
LD-006-017	32	LD-008-054	270	LD-020-051	194	LD-200-103	206
LD-006-018	32	LD-008-055	270	LD-020-052	194	LD-200-104	206
LD-006-019	32	LD-008-056	271	LD-020-053	194	LD-200-105	206
LD-006-020	34	LD-008-057	271	LD-020-054	194	LD-200-106	206
LD-007-001	27	LD-008-058	271	LD-020-055	194	LD-200-107	206
LD-007-002	27	LD-008-059	271	LD-020-056	194	LD-200-108	206
LD-007-003	27	LD-008-060	271	LD-020-060	192	LD-200-109	206
LD-007-004	27	LD-008-061	271	LD-020-061	192	LD-200-110	206
LD-008-001	35	LD-008-062	271	LD-020-062	192	LD-200-111	206
LD-008-002	35	LD-008-063	271	LD-020-063	192	LD-200-112	206
LD-008-003	35	LD-008-064	271	LD-020-064	192	LD-200-113	206
LD-008-004	35	LD-008-065	271	LD-020-065	193	LD-200-114	206
LD-008-005	35	LD-008-066	271	LD-020-066	193	LD-200-115	206
LD-008-006	35	LD-008-067	271	LD-020-067	193	LD-200-116	206
LD-008-007	35	LD-020-001	183	LD-020-068	193	LD-200-117	206
LD-008-008	35	LD-020-002	183	LD-020-069	193	LD-200-120	207
LD-008-009	35	LD-020-003	183	LD-020-070	193	LD-200-121	207
LD-008-010	35	LD-020-004	183	LD-020-071	193	LD-200-122	207
LD-008-011	35	LD-020-005	183	LD-020-072	193	LD-200-123	207
LD-008-012	35	LD-020-006	183	LD-030-001	188	LD-200-124	207
LD-008-013	35	LD-020-007	183	LD-030-002	188	LD-200-125	207
LD-008-014	35	LD-020-008	183	LD-030-003	188	LD-200-126	207
LD-008-015	35	LD-020-009	183	LD-030-004	188	LD-200-127	207
LD-008-016	35	LD-020-010	183	LD-030-005	188	LD-200-128	207
LD-008-017	35	LD-020-011	183	LD-030-030	188	LD-200-129	207
LD-008-018	35	LD-020-012	183	LD-030-031	188	LD-200-130	207
LD-008-020	269	LD-020-013	183	LD-030-032	180	LD-200-131	207
LD-008-021	269	LD-020-014	183	LD-030-033	180	LD-200-132	207
LD-008-022	269	LD-020-015	183	LD-040-001	121	LD-200-133	207
LD-008-023	269	LD-020-016	183	LD-040-002	121	LD-200-134	207
LD-008-024	269	LD-020-017	183	LD-040-003	121	LD-200-135	207
LD-008-025	269	LD-020-018	183	LD-040-004	121	LD-200-136	207
LD-008-026	269	LD-020-020	184	LD-040-005	121	LD-200-137	207
LD-008-027	269	LD-020-021	184	LD-040-006	121	LD-200-138	208
LD-008-028	269	LD-020-022	184	LD-100-001	187	LD-200-139	208
LD-008-029	269	LD-020-023	184	LD-100-002	187	LD-200-140	208
LD-008-030	269	LD-020-025	184	LD-100-003	187	LD-200-141	208

<b>Bestell-Nr. Ordering no.</b>	<b>Seite Page</b>	<b>Bestell-Nr. Ordering no.</b>	<b>Seite Page</b>	<b>Bestell-Nr. Ordering no.</b>	<b>Seite Page</b>	<b>Bestell-Nr. Ordering no.</b>	<b>Seite Page</b>
LD-200-142	208	LF-001-002	14	LF-001-073	15	LF-002-033	80
LD-200-143	208	LF-001-003	14	LF-001-074	15	LF-002-034	81
LD-200-144	208	LF-001-004	14	LF-001-075	15	LF-002-035	81
LD-200-145	208	LF-001-005	14	LF-001-076	15	LF-002-036	81
LD-200-146	208	LF-001-006	14	LF-001-077	15	LF-002-037	81
LD-200-147	208	LF-001-007	14	LF-001-078	15	LF-002-038	81
LD-200-148	208	LF-001-008	14	LF-001-079	15	LF-002-039	81
LD-200-149	208	LF-001-009	14	LF-001-080	15	LF-002-040	81
LD-200-150	208	LF-001-010	14	LF-001-081	15	LF-002-041	81
LD-200-151	208	LF-001-011	14	LF-001-082	15	LF-002-042	81
LD-200-152	208	LF-001-012	14	LF-001-083	15	LF-002-043	81
LD-200-153	208	LF-001-013	14	LF-001-084	15	LF-002-044	81
LD-200-154	208	LF-001-014	14	LF-001-085	15	LF-002-045	81
LD-200-200	203	LF-001-015	14	LF-001-086	15	LF-002-046	81
LD-200-201	203	LF-001-016	14	LF-001-087	15	LF-002-047	81
LD-200-202	204	LF-001-017	14	LF-001-088	15	LF-002-048	81
LD-200-203	204	LF-001-018	14	LF-001-090	16	LF-002-049	81
LD-200-204	203	LF-001-019	14	LF-001-091	16	LF-002-050	83
LD-200-205	203	LF-001-020	14	LF-001-092	16	LF-002-051	83
LD-200-207	204	LF-001-021	14	LF-001-093	16	LF-002-052	83
LD-300-001	277	LF-001-022	14	LF-001-094	16	LF-002-053	83
LD-300-002	277	LF-001-023	14	LF-001-095	16	LF-002-054	83
LD-300-003	277	LF-001-024	14	LF-001-100	16	LF-002-055	83
LD-300-004	277	LF-001-025	14	LF-001-101	16	LF-002-056	83
LD-300-005	277	LF-001-026	14	LF-001-102	16	LF-002-060	81
LD-300-006	277	LF-001-027	14	LF-001-105	16	LF-002-061	81
LD-300-007	277	LF-001-028	14	LF-001-106	16	LF-002-070	82
LD-300-008	277	LF-001-029	14	LF-001-107	16	LF-002-071	82
LD-300-009	277	LF-001-030	14	LF-001-108	16	LF-002-072	82
LD-300-010	277	LF-001-031	14	LF-002-001	79	LF-002-080	82
LD-300-011	277	LF-001-032	14	LF-002-002	79	LF-002-081	82
LD-300-012	277	LF-001-033	14	LF-002-003	79	LF-002-082	83
LD-300-013	278	LF-001-034	14	LF-002-004	79	LF-002-083	83
LD-300-015	277	LF-001-035	14	LF-002-005	79	LF-002-084	83
LD-300-050	276	LF-001-036	14	LF-002-006	79	LF-002-085	83
LD-300-051	276	LF-001-037	14	LF-002-007	79	LF-002-086	83
LD-300-052	276	LF-001-038	14	LF-002-008	79	LF-002-087	83
LD-300-053	276	LF-001-050	14	LF-002-009	79	LF-002-090	82
LD-300-054	276	LF-001-051	14	LF-002-010	79	LF-002-091	82
LD-300-055	276	LF-001-052	14	LF-002-011	79	LF-002-092	82
LD-300-056	276	LF-001-053	14	LF-002-012	79	LF-002-093	82
LD-300-057	278	LF-001-054	14	LF-002-013	79	LF-002-095	82
LD-300-100	278	LF-001-055	14	LF-002-014	79	LF-002-096	82
LD-300-101	278	LF-001-056	14	LF-002-015	79	LF-002-097	82
LD-300-102	278	LF-001-057	14	LF-002-016	79	LG-001-001	17
LD-300-103	278	LF-001-058	14	LF-002-017	79	LG-001-002	17
LD-300-104	278	LF-001-059	14	LF-002-018	80	LG-001-003	17
LD-300-105	278	LF-001-060	15	LF-002-019	80	LG-001-004	17
LD-300-106	278	LF-001-061	15	LF-002-020	80	LG-001-005	17
LD-300-107	278	LF-001-062	15	LF-002-021	80	LG-001-006	17
LD-300-108	278	LF-001-063	15	LF-002-022	80	LG-001-007	17
LD-300-200	279	LF-001-064	15	LF-002-023	80	LG-001-008	17
LD-300-201	279	LF-001-065	15	LF-002-024	80	LG-001-009	17
LD-300-202	279	LF-001-066	15	LF-002-025	80	LG-001-010	17
LD-300-203	279	LF-001-067	15	LF-002-026	80	LG-001-011	17
LD-300-204	279	LF-001-068	15	LF-002-027	80	LG-001-012	17
LD-300-205	279	LF-001-069	15	LF-002-028	80	LG-001-013	17
LD-300-206	279	LF-001-070	15	LF-002-030	80	LG-001-015	18
LD-300-207	279	LF-001-071	15	LF-002-031	80	LG-001-016	18
LF-001-001	14	LF-001-072	15	LF-002-032	80	LG-001-017	18

<b>Bestell-Nr.</b> <b>Ordering no.</b>	<b>Seite</b> <b>Page</b>	<b>Bestell-Nr.</b> <b>Ordering no.</b>	<b>Seite</b> <b>Page</b>	<b>Bestell-Nr.</b> <b>Ordering no.</b>	<b>Seite</b> <b>Page</b>	<b>Bestell-Nr.</b> <b>Ordering no.</b>	<b>Seite</b> <b>Page</b>
LG-001-020	18	LH-001-067	142	LH-001-143	146	LH-001-216	51
LG-001-021	18	LH-001-071	142	LH-001-144	146	LH-001-217	51
LG-001-022	18	LH-001-072	142	LH-001-145	146	LH-001-220	51
LG-001-023	18	LH-001-073	142	LH-001-146	146	LH-001-221	51
LG-001-025	18	LH-001-074	142	LH-001-147	146	LH-001-222	51
LG-001-026	18	LH-001-075	142	LH-001-148	146	LH-001-223	51
LG-001-027	18	LH-001-076	142	LH-001-149	146	LH-001-224	51
LG-001-028	18	LH-001-081	143	LH-001-151	147	LH-001-225	51
LG-002-001	19	LH-001-082	143	LH-001-152	147	LH-001-226	51
LG-002-002	19	LH-001-083	143	LH-001-153	147	LH-001-227	51
LG-002-003	19	LH-001-084	143	LH-001-154	147	LH-001-228	52
LG-002-004	19	LH-001-085	143	LH-001-155	147	LH-001-229	52
LG-002-005	19	LH-001-086	143	LH-001-156	147	LH-001-230	50
LG-002-006	19	LH-001-087	143	LH-001-157	147	LH-001-231	50
LG-002-011	19	LH-001-088	102	LH-001-158	147	LH-001-232	50
LG-003-001	19	LH-001-088	143	LH-001-161	147	LH-001-233	50
LG-003-002	19	LH-001-089	102	LH-001-162	147	LH-001-234	50
LG-003-003	19	LH-001-089	143	LH-001-163	147	LH-001-235	50
LG-003-004	19	LH-001-092	143	LH-001-164	147	LH-001-249	52
LH-001-000	140	LH-001-093	143	LH-001-165	147	LH-001-250	52
LH-001-001	140	LH-001-094	143	LH-001-166	147	LH-001-251	52
LH-001-002	140	LH-001-095	143	LH-001-167	147	LH-001-252	52
LH-001-003	140	LH-001-096	143	LH-001-168	147	LH-001-253	52
LH-001-004	140	LH-001-097	143	LH-001-171	48	LH-001-254	52
LH-001-005	140	LH-001-098	143	LH-001-172	48	LH-001-255	52
LH-001-006	140	LH-001-099	143	LH-001-173	48	LH-001-256	52
LH-001-007	140	LH-001-102	144	LH-001-174	48	LH-001-257	52
LH-001-011	140	LH-001-103	144	LH-001-175	48	LH-001-260	148
LH-001-012	140	LH-001-104	144	LH-001-176	48	LH-001-261	148
LH-001-013	140	LH-001-105	144	LH-001-177	48	LH-001-262	148
LH-001-014	140	LH-001-106	144	LH-001-178	48	LH-001-263	148
LH-001-015	140	LH-001-107	144	LH-001-179	48	LH-001-269	23
LH-001-016	140	LH-001-108	144	LH-001-180	48	LH-001-270	23
LH-001-017	140	LH-001-109	144	LH-001-181	49	LH-001-271	23
LH-001-018	140	LH-001-112	144	LH-001-182	49	LH-001-272	23
LH-001-021	141	LH-001-113	144	LH-001-183	49	LH-001-273	23
LH-001-022	141	LH-001-114	144	LH-001-184	49	LH-001-274	23
LH-001-023	141	LH-001-115	144	LH-001-185	49	LH-001-275	23
LH-001-024	141	LH-001-116	144	LH-001-186	49	LH-001-276	23
LH-001-025	141	LH-001-117	144	LH-001-187	49	LH-001-277	23
LH-001-026	141	LH-001-118	144	LH-001-188	49	LH-001-278	23
LH-001-027	141	LH-001-119	144	LH-001-189	49	LH-001-280	52
LH-001-028	141	LH-001-122	145	LH-001-190	49	LH-001-281	52
LH-001-029	141	LH-001-123	145	LH-001-191	49	LH-001-282	52
LH-001-041	141	LH-001-124	145	LH-001-192	49	LH-001-285	102
LH-001-042	141	LH-001-125	145	LH-001-200	50	LH-001-286	102
LH-001-043	141	LH-001-126	145	LH-001-201	50	LH-001-287	102
LH-001-044	141	LH-001-127	145	LH-001-202	50	LH-001-288	102
LH-001-045	141	LH-001-128	145	LH-001-203	50	LH-001-289	52
LH-001-046	141	LH-001-129	145	LH-001-204	50	LH-001-290	52
LH-001-047	141	LH-001-132	145	LH-001-205	50	LH-001-300	148
LH-001-048	141	LH-001-133	145	LH-001-206	50	LH-001-301	148
LH-001-049	141	LH-001-134	145	LH-001-207	50	LH-001-302	148
LH-001-058	142	LH-001-135	145	LH-001-208	50	LH-001-303	148
LH-001-059	142	LH-001-136	145	LH-001-210	51	LH-001-304	148
LH-001-060	142	LH-001-137	145	LH-001-211	51	LH-001-305	148
LH-001-061	142	LH-001-138	145	LH-001-212	51	LH-001-306	148
LH-001-062	142	LH-001-139	145	LH-001-213	51	LH-001-307	148
LH-001-065	142	LH-001-141	146	LH-001-214	51	LH-001-308	148
LH-001-066	142	LH-001-142	146	LH-001-215	51	LH-001-309	148



<b>Bestell-Nr. Ordering no.</b>	<b>Seite Page</b>	<b>Bestell-Nr. Ordering no.</b>	<b>Seite Page</b>	<b>Bestell-Nr. Ordering no.</b>	<b>Seite Page</b>	<b>Bestell-Nr. Ordering no.</b>	<b>Seite Page</b>
LH-002-001	149	LJ-002-001	21	LJ-003-024	85	ZA-001-075	240
LH-002-002	149	LJ-002-002	21	LJ-003-024	182	ZA-001-076	240
LH-002-003	149	LJ-002-003	21	LJ-003-025	85	ZA-001-077	240
LH-002-005	149	LJ-002-004	21	LJ-003-025	182	ZA-001-078	240
LH-002-006	149	LJ-002-005	21	LJ-003-026	148	ZA-001-079	240
LH-002-009	150	LJ-002-006	21	LK-001-001	86	ZA-001-080	240
LH-002-020	150	LJ-002-007	21	LK-001-002	86	ZA-001-081	240
LH-002-021	150	LJ-002-008	21	LK-001-003	86	ZA-001-082	240
LH-002-022	150	LJ-002-009	21	LK-001-004	86	ZA-001-083	240
LH-003-001	150	LJ-002-010	21	LK-001-005	86	ZA-001-084	240
LH-003-002	150	LJ-002-011	21	LK-001-006	86	ZA-001-085	240
LH-003-011	23	LJ-002-012	21	LK-001-007	90	ZA-001-086	240
LH-003-011	150	LJ-002-013	21	LK-001-008	90	ZA-001-087	240
LH-003-012	23	LJ-002-014	21	LK-002-001	94	ZA-001-088	240
LH-003-012	150	LJ-002-015	21	LK-002-002	94	ZA-001-089	240
LH-003-013	23	LJ-002-016	21	LK-002-003	94	ZA-001-090	240
LH-003-014	23	LJ-002-017	21	LK-002-004	94	ZA-001-091	241
LH-003-015	23	LJ-002-018	21	LK-002-005	94	ZA-001-092	241
LH-003-016	23	LJ-002-019	21	LK-010-001	91	ZA-001-093	241
LH-003-017	23	LJ-002-020	21	LK-010-002	91	ZA-001-094	241
LH-003-018	23	LJ-002-021	21	LL-001-001	25	ZA-001-095	241
LH-004-001	150	LJ-002-022	21	LL-001-001	84	ZA-001-096	241
LH-004-002	150	LJ-002-025	22	LL-001-002	25	ZA-001-097	241
LH-004-003	150	LJ-002-026	22	LL-001-002	84	ZA-001-098	241
LH-004-004	150	LJ-002-027	22	LL-001-003	25	ZA-001-099	241
LH-004-005	150	LJ-002-028	22	LL-001-004	25	ZA-001-100	241
LH-005-001	151	LJ-002-029	22	LR-001-001	123	ZA-001-101	241
LH-005-002	151	LJ-002-030	22	LR-001-002	274	ZA-001-102	241
LH-005-003	151	LJ-002-031	22	LR-001-003	274	ZA-001-103	241
LH-005-004	151	LJ-002-032	22	LR-001-010	274	ZA-001-104	241
LH-005-005	151	LJ-002-033	22	LR-001-011	274	ZA-001-105	241
LH-005-006	151	LJ-002-035	205	LR-001-012	274	ZA-001-106	241
LH-005-007	151	LJ-002-036	205	LR-001-013	274	ZA-001-150	242
LH-005-008	151	LJ-002-037	205	LR-001-014	274	ZA-001-151	242
LI-001-005	73	LJ-002-038	205	LR-001-015	274	ZA-001-152	242
LI-001-006	73	LJ-002-039	205	LR-001-016	274	ZA-001-153	242
LI-001-007	73	LJ-002-040	205	LR-001-017	274	ZA-001-226	242
LI-001-008	73	LJ-002-041	205	LR-001-018	274	ZA-001-227	242
LI-001-009	73	LJ-002-042	205	LR-001-019	274	ZA-001-256	242
LI-001-010	73	LJ-002-043	205	LR-001-020	275	ZA-001-257	242
LI-001-011	126	LJ-003-001	24	LR-002-001	123	ZA-001-263	242
LI-001-012	126	LJ-003-001	85	LR-002-002	123	ZA-001-264	242
LI-001-013	126	LJ-003-002	24	LR-002-003	123	ZA-001-272	242
LI-001-014	126	LJ-003-002	85	LR-002-004	115	ZA-001-273	242
LI-001-015	126	LJ-003-003	24	LR-002-005	115	ZA-001-274	242
LI-001-016	126	LJ-003-003	85	LR-002-006	121	ZA-001-294	234
LI-001-017	126	LJ-003-005	24	LR-002-020	94	ZA-001-295	234
LI-001-018	73	LJ-003-006	24	LR-002-021	94	ZA-001-296	234
LI-001-100	73	LJ-003-007	24	ZA-001-039	239	ZA-001-297	234
LI-001-101	73	LJ-003-008	24	ZA-001-041	239	ZA-001-298	234
LI-001-102	73	LJ-003-009	24	ZA-001-043	239	ZA-001-299	234
LI-001-103	73	LJ-003-010	24	ZA-001-045	239	ZA-001-300	234
LI-001-104	73	LJ-003-020	85	ZA-001-061	239	ZA-001-301	234
LI-001-105	73	LJ-003-020	182	ZA-001-062	239	ZA-001-302	234
LI-001-110	126	LJ-003-021	85	ZA-001-063	239	ZA-001-303	235
LI-001-111	126	LJ-003-021	182	ZA-001-064	239	ZA-001-304	235
LI-001-112	126	LJ-003-022	85	ZA-001-069	239	ZA-001-305	235
LI-001-113	126	LJ-003-022	182	ZA-001-070	239	ZA-001-306	235
LI-001-114	126	LJ-003-023	85	ZA-001-073	239	ZA-001-307	235
LI-001-115	126	LJ-003-023	182	ZA-001-074	239	ZA-001-308	235



<b>Bestell-Nr. Ordering no.</b>	<b>Seite Page</b>	<b>Bestell-Nr. Ordering no.</b>	<b>Seite Page</b>	<b>Bestell-Nr. Ordering no.</b>	<b>Seite Page</b>	<b>Bestell-Nr. Ordering no.</b>	<b>Seite Page</b>
ZA-001-309	235	ZA-001-553	217	ZA-001-657	220	ZA-001-752	227
ZA-001-310	235	ZA-001-554	217	ZA-001-658	220	ZA-001-796	222
ZA-001-311	235	ZA-001-555	217	ZA-001-659	220	ZA-001-800	228
ZA-001-381	236	ZA-001-556	217	ZA-001-661	220	ZA-001-807	226
ZA-001-385	234	ZA-001-557	217	ZA-001-663	220	ZA-001-808	226
ZA-001-387	234	ZA-001-558	217	ZA-001-665	220	ZA-001-834	222
ZA-001-389	235	ZA-001-559	217	ZA-001-666	220	ZA-001-836	222
ZA-001-391	235	ZA-001-560	217	ZA-001-667	220	ZA-001-838	222
ZA-001-400	234	ZA-001-561	217	ZA-001-668	220	ZA-001-840	222
ZA-001-401	234	ZA-001-562	217	ZA-001-670	220	ZA-001-844	224
ZA-001-402	234	ZA-001-563	217	ZA-001-672	220	ZA-001-846	224
ZA-001-403	234	ZA-001-564	217	ZA-001-674	220	ZA-001-848	224
ZA-001-404	234	ZA-001-565	217	ZA-001-675	220	ZA-001-850	224
ZA-001-405	235	ZA-001-566	217	ZA-001-676	220	ZA-001-852	224
ZA-001-406	235	ZA-001-567	217	ZA-001-677	224	ZA-001-854	224
ZA-001-407	235	ZA-001-568	217	ZA-001-678	224	ZA-001-856	224
ZA-001-408	235	ZA-001-569	217	ZA-001-681	224	ZA-001-858	224
ZA-001-442	235	ZA-001-570	217	ZA-001-682	224	ZA-001-860	225
ZA-001-457	236	ZA-001-571	217	ZA-001-683	225	ZA-001-861	225
ZA-001-462	236	ZA-001-572	217	ZA-001-684	225	ZA-001-862	224
ZA-001-486	56	ZA-001-573	218	ZA-001-685	220	ZA-001-864	224
ZA-001-486	114	ZA-001-574	218	ZA-001-686	220	ZA-001-868	224
ZA-001-486	237	ZA-001-575	218	ZA-001-687	220	ZA-001-872	224
ZA-001-486-1	56	ZA-001-576	218	ZA-001-688	220	ZA-001-874	224
ZA-001-487	56	ZA-001-577	218	ZA-001-689	221	ZA-001-881	215
ZA-001-487	114	ZA-001-578	218	ZA-001-690	221	ZA-001-882	215
ZA-001-487	237	ZA-001-579	218	ZA-001-691	225	ZA-001-886	215
ZA-001-487-1	56	ZA-001-580	218	ZA-001-692	225	ZA-001-889	260
ZA-001-488	56	ZA-001-581	218	ZA-001-706	221	ZA-001-891	260
ZA-001-488	237	ZA-001-582	218	ZA-001-707	228	ZA-001-894	260
ZA-001-488-1	56	ZA-001-583	218	ZA-001-708	124	ZA-001-896	261
ZA-001-491	114	ZA-001-584	218	ZA-001-719	221	ZA-001-897	261
ZA-001-491	237	ZA-001-585	218	ZA-001-720	221	ZA-001-906	261
ZA-001-492	236	ZA-001-586	218	ZA-001-721	222	ZA-001-907	261
ZA-001-493	236	ZA-001-587	218	ZA-001-722	222	ZA-001-908	261
ZA-001-495	236	ZA-001-588	218	ZA-001-723	222	ZA-001-909	261
ZA-001-497	236	ZA-001-589	218	ZA-001-724	222	ZA-001-910	261
ZA-001-503	236	ZA-001-590	218	ZA-001-725	221	ZA-001-911	261
ZA-001-523	234	ZA-001-610	219	ZA-001-730	229	ZA-001-928	261
ZA-001-524	235	ZA-001-611	219	ZA-001-731	229	ZA-001-929	261
ZA-001-533	216	ZA-001-612	219	ZA-001-732	229	ZA-001-930	261
ZA-001-534	216	ZA-001-613	219	ZA-001-733	229	ZA-001-931	261
ZA-001-535	216	ZA-001-614	219	ZA-001-734	229	ZA-001-932	261
ZA-001-536	216	ZA-001-615	219	ZA-001-735	229	ZA-001-933	261
ZA-001-537	216	ZA-001-616	219	ZA-001-736	229	ZA-001-934	261
ZA-001-538	216	ZA-001-617	219	ZA-001-737	229	ZA-001-935	262
ZA-001-539	216	ZA-001-618	219	ZA-001-738	227	ZA-001-936	262
ZA-001-540	216	ZA-001-619	219	ZA-001-739	227	ZA-001-937	262
ZA-001-541	216	ZA-001-620	219	ZA-001-740	227	ZA-001-960	260
ZA-001-542	216	ZA-001-621	219	ZA-001-741	227	ZA-001-966	260
ZA-001-543	216	ZA-001-622	219	ZA-001-742	226	ZA-001-969	261
ZA-001-544	216	ZA-001-623	219	ZA-001-743	226	ZA-001-970	261
ZA-001-545	216	ZA-001-624	219	ZA-001-744	226	ZA-001-971	261
ZA-001-546	216	ZA-001-625	219	ZA-001-745	226	ZA-001-972	261
ZA-001-547	216	ZA-001-626	219	ZA-001-746	226	ZA-002-003	265
ZA-001-548	216	ZA-001-627	219	ZA-001-747	226	ZA-002-004	265
ZA-001-549	216	ZA-001-628	219	ZA-001-748	226	ZA-002-049	243
ZA-001-550	216	ZA-001-629	219	ZA-001-749	226	ZA-002-051	243
ZA-001-551	217	ZA-001-649	224	ZA-001-750	227	ZA-002-052	243
ZA-001-552	217	ZA-001-651	224	ZA-001-751	227	ZA-002-054	243

<b>Bestell-Nr. Ordering no.</b>	<b>Seite Page</b>	<b>Bestell-Nr. Ordering no.</b>	<b>Seite Page</b>	<b>Bestell-Nr. Ordering no.</b>	<b>Seite Page</b>	<b>Bestell-Nr. Ordering no.</b>	<b>Seite Page</b>
ZA-002-081	244	ZA-002-171	249	ZA-002-316	255	ZA-003-244	177
ZA-002-082	244	ZA-002-172	249	ZA-002-317	255	ZA-003-245	177
ZA-002-083	244	ZA-002-173	249	ZA-002-319	255	ZA-003-246	177
ZA-002-084	244	ZA-002-174	249	ZA-002-320	255	ZA-003-248	177
ZA-002-085	244	ZA-002-175	249	ZA-002-321	255	ZA-003-249	177
ZA-002-086	244	ZA-002-176	249	ZA-002-322	255	ZA-003-250	177
ZA-002-087	244	ZA-002-177	247	ZA-002-325	256	ZA-003-251	177
ZA-002-088	244	ZA-002-178	247	ZA-002-326	256	ZA-003-252	177
ZA-002-089	244	ZA-002-179	247	ZA-002-332	256	ZA-003-253	177
ZA-002-090	244	ZA-002-180	247	ZA-002-333	256	ZA-003-254	177
ZA-002-091	244	ZA-002-181	245	ZA-002-334	256	ZA-003-256	179
ZA-002-092	244	ZA-002-182	245	ZA-002-335	256	ZA-003-257	179
ZA-002-117	245	ZA-002-183	245	ZA-002-336	256	ZA-003-258	179
ZA-002-118	245	ZA-002-184	245	ZA-002-337	256	ZA-003-259	180
ZA-002-119	245	ZA-002-185	245	ZA-002-338	256	ZA-003-262	180
ZA-002-120	245	ZA-002-186	245	ZA-002-339	256	ZA-003-263	180
ZA-002-121	244	ZA-002-187	245	ZA-002-589	273	ZA-003-264	180
ZA-002-122	244	ZA-002-188	245	ZA-002-590	273	ZA-003-283	189
ZA-002-123	244	ZA-002-189	245	ZA-002-591	273	ZA-003-284	189
ZA-002-124	244	ZA-002-190	245	ZA-002-592	273	ZA-003-285	189
ZA-002-125	244	ZA-002-191	246	ZA-002-593	273	ZA-003-286	189
ZA-002-126	244	ZA-002-192	246	ZA-002-594	273	ZA-003-290	190
ZA-002-133	247	ZA-002-193	246	ZA-002-595	273	ZA-003-291	190
ZA-002-134	247	ZA-002-194	246	ZA-002-596	273	ZA-003-292	190
ZA-002-135	247	ZA-002-195	246	ZA-002-597	273	ZA-003-293	190
ZA-002-136	247	ZA-002-196	246	ZA-002-598	273	ZA-003-294	190
ZA-002-137	247	ZA-002-197	246	ZA-002-599	272	ZA-003-295	190
ZA-002-138	247	ZA-002-198	246	ZA-002-600	272	ZA-003-296	190
ZA-002-139	247	ZA-002-199	246	ZA-002-601	272	ZA-003-297	190
ZA-002-140	247	ZA-002-216	250	ZA-002-602	272	ZA-003-298	190
ZA-002-141	247	ZA-002-217	250	ZA-002-603	272	ZA-003-299	190
ZA-002-142	247	ZA-002-218	250	ZA-002-604	272	ZA-003-300	190
ZA-002-143	247	ZA-002-280	250	ZA-002-605	272	ZA-003-301	190
ZA-002-144	248	ZA-002-281	250	ZA-002-606	272	ZA-003-302	190
ZA-002-145	248	ZA-002-282	250	ZA-002-607	272	ZA-003-303	190
ZA-002-146	248	ZA-002-283	250	ZA-002-616	272	ZA-003-304	190
ZA-002-147	248	ZA-002-284	251	ZA-002-617	272	ZA-003-305	190
ZA-002-148	248	ZA-002-285	251	ZA-002-618	272	ZA-003-306	190
ZA-002-149	248	ZA-002-286	251	ZA-002-619	272	ZA-003-307	190
ZA-002-150	248	ZA-002-287	251	ZA-002-620	272	ZA-003-308	190
ZA-002-151	248	ZA-002-288	251	ZA-002-621	272	ZA-003-309	190
ZA-002-152	248	ZA-002-289	251	ZA-002-622	272	ZA-003-310	190
ZA-002-153	248	ZA-002-290	251	ZA-002-696	275	ZA-003-311	190
ZA-002-154	248	ZA-002-291	251	ZA-002-703	275	ZA-003-312	190
ZA-002-155	248	ZA-002-292	251	ZA-003-134	243	ZA-003-313	190
ZA-002-156	248	ZA-002-293	251	ZA-003-135	243	ZA-003-314	190
ZA-002-157	248	ZA-002-294	251	ZA-003-136	243	ZA-003-315	190
ZA-002-158	248	ZA-002-295	251	ZA-003-137	243	ZA-003-316	236
ZA-002-159	249	ZA-002-296	251	ZA-003-142	243	ZA-003-415	254
ZA-002-160	249	ZA-002-297	251	ZA-003-144	243	ZA-003-424	121
ZA-002-161	249	ZA-002-298	251	ZA-003-145	243	ZA-003-425	121
ZA-002-162	249	ZA-002-299	245	ZA-003-146	243	ZA-003-426	121
ZA-002-163	249	ZA-002-300	245	ZA-003-151	243	ZA-003-427	121
ZA-002-164	249	ZA-002-301	245	ZA-003-152	243	ZA-003-562	180
ZA-002-165	249	ZA-002-310	255	ZA-003-153	243	ZA-003-563	180
ZA-002-166	249	ZA-002-311	255	ZA-003-154	243	ZA-003-564	181
ZA-002-167	249	ZA-002-312	255	ZA-003-240	177	ZA-003-565	181
ZA-002-168	249	ZA-002-313	255	ZA-003-241	177	ZA-003-566	181
ZA-002-169	249	ZA-002-314	255	ZA-003-242	177	ZA-003-581	181
ZA-002-170	249	ZA-002-315	255	ZA-003-243	177	ZA-003-582	181

<b>Bestell-Nr. Ordering no.</b>	<b>Seite Page</b>	<b>Bestell-Nr. Ordering no.</b>	<b>Seite Page</b>	<b>Bestell-Nr. Ordering no.</b>	<b>Seite Page</b>	<b>Bestell-Nr. Ordering no.</b>	<b>Seite Page</b>
ZA-003-583	181	ZA-004-357	259	ZA-004-434	266	ZA-004-495	230
ZA-003-584	181	ZA-004-358	259	ZA-004-435	266	ZA-004-496	231
ZA-003-585	181	ZA-004-359	259	ZA-004-436	266	ZA-004-497	231
ZA-003-586	181	ZA-004-360	259	ZA-004-437	266	ZA-004-498	231
ZA-003-587	181	ZA-004-361	251	ZA-004-438	266	ZA-004-499	231
ZA-003-588	181	ZA-004-362	84	ZA-004-439	266	ZA-004-500	231
ZA-003-589	181	ZA-004-363	84	ZA-004-440	266	ZA-004-501	231
ZA-003-590	181	ZA-004-364	114	ZA-004-441	266	ZA-004-502	231
ZA-003-591	181	ZA-004-364	237	ZA-004-442	266	ZA-004-503	231
ZA-003-592	181	ZA-004-365	114	ZA-004-443	266	ZA-004-504	231
ZA-003-593	181	ZA-004-365	237	ZA-004-444	266	ZA-004-505	231
ZA-003-997	234	ZA-004-366	222	ZA-004-445	266	ZA-004-506	231
ZA-004-006	235	ZA-004-367	222	ZA-004-446	266	ZA-004-507	231
ZA-004-010	234	ZA-004-368	225	ZA-004-447	266	ZA-004-508	231
ZA-004-011	234	ZA-004-369	225	ZA-004-448	263	ZA-004-509	231
ZA-004-013	235	ZA-004-370	221	ZA-004-449	263	ZA-004-510	231
ZA-004-014	238	ZA-004-371	222	ZA-004-450	263	ZA-004-511	231
ZA-004-046	225	ZA-004-372	222	ZA-004-451	263	ZA-004-512	231
ZA-004-083	225	ZA-004-373	222	ZA-004-452	263	ZA-004-513	223
ZA-004-185	215	ZA-004-374	222	ZA-004-453	263	ZA-004-514	223
ZA-004-264	91	ZA-004-375	222	ZA-004-454	263	ZA-004-515	223
ZA-004-265	76	ZA-004-376	222	ZA-004-455	263	ZA-004-516	223
ZA-004-266	91	ZA-004-377	222	ZA-004-456	264	ZA-004-517	223
ZA-004-272	238	ZA-004-378	222	ZA-004-457	264	ZA-004-518	223
ZA-004-276	257	ZA-004-382	238	ZA-004-458	264	ZA-004-519	223
ZA-004-277	257	ZA-004-383	238	ZA-004-459	264	ZA-004-520	223
ZA-004-278	256	ZA-004-400	263	ZA-004-460	262	ZA-004-521	223
ZA-004-325	275	ZA-004-401	263	ZA-004-461	262	ZA-004-522	223
ZA-004-326	275	ZA-004-402	263	ZA-004-462	264	ZA-004-523	226
ZA-004-327	238	ZA-004-403	263	ZA-004-463	264	ZA-004-524	226
ZA-004-328	220	ZA-004-404	263	ZA-004-464	264	ZA-004-525	226
ZA-004-329	220	ZA-004-405	263	ZA-004-465	264	ZA-004-526	223
ZA-004-330	225	ZA-004-406	265	ZA-004-466	264	ZA-004-527	223
ZA-004-331	255	ZA-004-407	265	ZA-004-467	264	ZA-004-528	223
ZA-004-332	255	ZA-004-408	265	ZA-004-468	264	ZA-004-529	223
ZA-004-333	257	ZA-004-409	265	ZA-004-469	264	ZA-004-530	223
ZA-004-334	257	ZA-004-410	265	ZA-004-470	264	ZA-004-531	223
ZA-004-334-1	257	ZA-004-411	265	ZA-004-471	264	ZA-004-532	223
ZA-004-335	257	ZA-004-412	265	ZA-004-472	264	ZA-004-533	223
ZA-004-336	257	ZA-004-413	265	ZA-004-473	264	ZA-004-534	223
ZA-004-337	257	ZA-004-414	230	ZA-004-474	267	ZA-004-535	223
ZA-004-338	257	ZA-004-415	230	ZA-004-475	267	ZA-004-536	229
ZA-004-339	257	ZA-004-416	230	ZA-004-476	267	ZA-004-537	229
ZA-004-340	257	ZA-004-417	230	ZA-004-477	267	ZA-004-538	229
ZA-004-341	258	ZA-004-418	265	ZA-004-478	267	ZA-004-539	229
ZA-004-342	258	ZA-004-419	265	ZA-004-479	267	ZA-004-540	229
ZA-004-343	258	ZA-004-420	265	ZA-004-480	267	ZA-004-541	229
ZA-004-344	258	ZA-004-421	265	ZA-004-481	267	ZA-004-544	225
ZA-004-345	258	ZA-004-422	265	ZA-004-482	267	ZA-004-545	225
ZA-004-346	258	ZA-004-423	265	ZA-004-483	267	ZA-004-546	222
ZA-004-347	258	ZA-004-424	265	ZA-004-484	267	ZA-004-547	227
ZA-004-348	258	ZA-004-425	265	ZA-004-485	267	ZA-004-548	228
ZA-004-349	258	ZA-004-426	266	ZA-004-486	267	ZA-004-549	228
ZA-004-350	259	ZA-004-427	266	ZA-004-487	267	ZA-004-550	189
ZA-004-351	256	ZA-004-428	266	ZA-004-488	267	ZA-004-551	221
ZA-004-352	256	ZA-004-429	266	ZA-004-489	267	ZA-004-552	237
ZA-004-353	256	ZA-004-430	266	ZA-004-491	230	ZA-004-553	257
ZA-004-354	259	ZA-004-431	266	ZA-004-492	230	ZA-004-554	257
ZA-004-355	259	ZA-004-432	266	ZA-004-493	230	ZA-004-555	257
ZA-004-356	259	ZA-004-433	266	ZA-004-494	230	ZA-004-556	257

<b>Bestell-Nr. Ordering no.</b>	<b>Seite Page</b>	<b>Bestell-Nr. Ordering no.</b>	<b>Seite Page</b>	<b>Bestell-Nr. Ordering no.</b>	<b>Seite Page</b>
ZA-004-557	255	ZA-004-636	253	ZA-004-698	179
ZA-004-558	255	ZA-004-637	253	ZA-004-699	179
ZA-004-559	258	ZA-004-638	253	ZA-004-700	179
ZA-004-560	258	ZA-004-639	253	ZA-004-701	179
ZA-004-561	179	ZA-004-640	253	ZA-004-702	179
ZA-004-567	178	ZA-004-641	253	ZA-004-703	179
ZA-004-568	178	ZA-004-642	253	ZA-004-704	179
ZA-004-569	178	ZA-004-643	253	ZA-004-705	179
ZA-004-570	178	ZA-004-644	253	ZA-004-706	179
ZA-004-571	178	ZA-004-645	253	ZA-004-707	257
ZA-004-572	178	ZA-004-646	253	ZA-004-708	257
ZA-004-573	178	ZA-004-647	254	ZA-004-720	224
ZA-004-574	178	ZA-004-648	254	ZA-004-721	224
ZA-004-575	178	ZA-004-649	232		
ZA-004-576	178	ZA-004-650	232		
ZA-004-577	178	ZA-004-651	232		
ZA-004-578	178	ZA-004-652	232		
ZA-004-579	178	ZA-004-653	232		
ZA-004-580	178	ZA-004-654	232		
ZA-004-594	189	ZA-004-655	232		
ZA-004-595	189	ZA-004-656	232		
ZA-004-596	250	ZA-004-657	232		
ZA-004-598	250	ZA-004-658	232		
ZA-004-599	250	ZA-004-659	232		
ZA-004-600	250	ZA-004-660	232		
ZA-004-601	250	ZA-004-661	232		
ZA-004-602	250	ZA-004-662	232		
ZA-004-603	250	ZA-004-664	233		
ZA-004-604	250	ZA-004-665	233		
ZA-004-605	251	ZA-004-666	233		
ZA-004-606	252	ZA-004-667	233		
ZA-004-607	252	ZA-004-668	233		
ZA-004-608	252	ZA-004-669	233		
ZA-004-609	252	ZA-004-670	233		
ZA-004-610	252	ZA-004-671	233		
ZA-004-611	252	ZA-004-672	268		
ZA-004-612	252	ZA-004-673	268		
ZA-004-613	252	ZA-004-674	268		
ZA-004-614	252	ZA-004-675	268		
ZA-004-615	252	ZA-004-676	268		
ZA-004-616	252	ZA-004-677	268		
ZA-004-617	252	ZA-004-678	268		
ZA-004-618	252	ZA-004-679	268		
ZA-004-619	253	ZA-004-680	238		
ZA-004-620	246	ZA-004-681	238		
ZA-004-621	246	ZA-004-682	238		
ZA-004-622	246	ZA-004-683	238		
ZA-004-623	246	ZA-004-684	238		
ZA-004-624	253	ZA-004-685	238		
ZA-004-625	253	ZA-004-686	238		
ZA-004-626	246	ZA-004-687	238		
ZA-004-627	246	ZA-004-688	238		
ZA-004-628	246	ZA-004-689	238		
ZA-004-629	246	ZA-004-690	238		
ZA-004-631	254	ZA-004-691	238		
ZA-004-632	254	ZA-004-692	232		
ZA-004-633	254	ZA-004-694	262		
ZA-004-633-1	254	ZA-004-695	262		
ZA-004-634	254	ZA-004-696	262		
ZA-004-635	254	ZA-004-697	179		

Lined area for notes, consisting of alternating light blue and white horizontal bands.

Lined writing area with alternating light blue and white horizontal bands.





STEMA Medizintechnik GmbH  
H.-E.-Bussestr. 4  
78333 Stockach - Germany

Phone: 0049 (0) 77 71 / 87 53 51  
Fax: 0049 (0) 77 71 / 87 53 50

[info@stema-medizintechnik.de](mailto:info@stema-medizintechnik.de)  
[www.stema-medizintechnik.de](http://www.stema-medizintechnik.de)